



20
23

mares

BUYERS GUIDE



COMPANY PRESENTATION

MARES - OVER SEVEN DECADES OF DIVING EXCELLENCE

Since 1949 Mares has been a world leader in the manufacturing and global distribution of dive products. A strong athlete and WWI Austrian Royal Navy diver, Ludovico Mares founded Mares through his desire to share his extreme passion for the sea with the rest of the world. From a few spearguns, masks, and fins, Mares grew of humble beginnings into the world's leading dive equipment manufacturer. This passion still drives the spirit of Mares on the relentless quest for innovation, reliability, the best technology, and state-of-the-art performance. Every year, Mares stays true to its Mission Statement to help every diver:

"ENJOY DIVING WITH ADVANCED PERFORMANCE THROUGH SUPERIOR TECHNOLOGY."

Based in Rapallo, Italy, Mares employees gain daily inspiration from the majestic Mediterranean Sea. The strategic location in this picturesque town on the Italian Riviera allows the Mares product development team quick access to great diving, where they fine-tune every new product to meet the needs of each and every diver. Constant investment in innovation and continuous advanced research makes Mares the leader in safe and reliable underwater equipment manufacturing.

WATERSPORT BRANDS

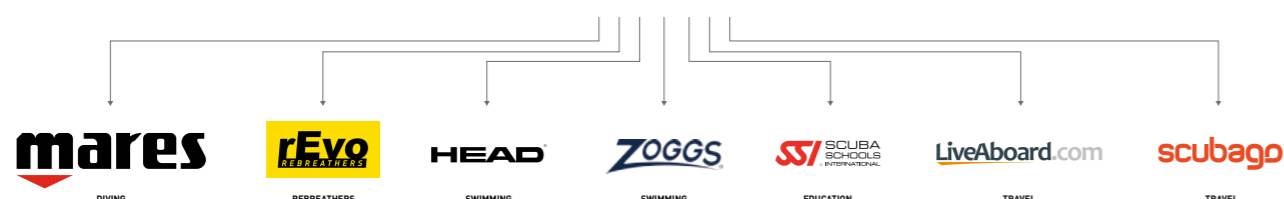

SUPPORTING AQUATIC ADVENTURES WORLDWIDE

Over the past years, Mares has created five distinct divisions to offer all possible types of equipment to meet the needs of every person with a passion for the sea. The Mares Diving line brings innovative products to scuba divers year after year. The XR-Extended Range line introduces divers to the more technical world of diving, offering equipment specifically designed for different gas blends and more challenging dives. Pure Passion is Mares' freediving and spearfishing line and provides state-of-the-art freediving equipment to those dedicated to underwater exploration on a single breath. Mares Aquazone offers aquatic enthusiasts gear specifically suited for swimming and snorkeling. The Mares Diving Center line offers unique products designed for the specific needs of dive centers.

In addition to our extensive offering of underwater equipment, Mares partners with six other watersport brands under the Head Sports family to best support your customers' active lifestyles. These brands include rEvo rebreathers, Head swimming, Zoggs swimming, Scuba Schools International, Liveaboard.com, and Scubago.com. With these strong partnerships, the Mares product range can truly meet the needs of anyone who loves diving and the aquatic world.

INTERNET POLICY

POLICY FOR THE DISTRIBUTION OF MARES PRODUCTS OVER THE INTERNET

In recent years, distribution over the internet has increasingly become an additional means of distribution besides traditional stationary trade. In particular, internet distribution offers new possibilities to dealers of MARES to sell to the final customer.

Even though MARES considers stationary sport retailing as an indispensable means of distribution with a view to providing information and advice to the final customer, MARES also welcomes the increasing use of the internet as a parallel channel of distribution, as additional selling opportunities are in the interest both of the manufacturer and of the dealer and increase overall market coverage.

However, MARES as manufacturer is responsible to ensure, together with its dealers, that the specificities of the internet distribution are taken into account as the final customer has no opportunity to inspect the products and to assess their suitability for use in sport. Thus, in light of the potential risks which are connected to the use in sport of the sold products, MARES and its dealers have to ensure that the distribution over the internet does not give rise to any detriment or risk to the final customer and that customer dissatisfaction based on wrong expectations of the product characteristics due to incomplete or wrong information is avoided.

For this reason, MARES has established the following guidelines, which cover the distribution of MARES products over the internet to final customers by all dealers.

For purposes of these guidelines, MARES products are all products distributed by MARES. The dealer commits not to sell MARES products over the internet outside the EU.

The way of presentation of the sold products over the internet shall ensure that all essential characteristics, features and parts of the product are truthfully displayed, and allow the final customer to assess the suitability of the product with a view to his sporting skill, as well as any dangers and risks connected to the envisaged use in sport. With a view to this, the dealer shall implement appropriate technical and design solutions for the presentation of the products, and include for each product a link at a clearly visible location to the respective product description on www.mares.com, to allow the final customer to access further information and technical data on the respective MARES products.

For consumer safety, warranty and product liability reasons and to avoid any possible confusion, dealer shall only advertise and sell new and unused MARES products in their original packaging and with the appropriate user manual enclosed.

With a view to the technical nature of the products, the dealer shall ensure that telephone support is available to final customers in case of distribution over the internet. Support shall be provided by qualified personnel during normal trading hours to a sufficient extent under a local number and the language of the respective country of distribution. The telephone support shall offset, in particular, the missing opportunity for the final customer to assess the product characteristics, and shall ensure that the use of the MARES product will not give rise to any detriment or risk to the final customer due to insufficient advice. The dealer commits to provide the qualified personnel with regular trainings regarding product and technical innovations and safe handling.

In order to avoid any risk of misleading the final customer, in particular by confusion of MARES products with the products of other manufacturers, MARES products shall be presented in an exclusive area on the website which is specifically designed for that purpose, as is the case for exclusive areas in stationary points of sale. No other products or brands of other manufacturers shall be presented in this area. If the website has a search function, the

dealer shall ensure that MARES products are not confused with products of other manufacturers and that, to the extent possible, no other products are displayed as a result of targeted searches for MARES products. This is also necessary to reduce safety risks to the final customer which may result from a combination, by the final customer due to lack of advice, of MARES products with products of other manufacturers that may compromise safety.

The dealer shall ensure that the website for the sale of the products and the information provided on the website are in compliance with all relevant legal requirements, in particular with the legislation on electronic commerce and on data protection, and contain all information and instructions as required by the law, in particular by the provisions in relation to distance selling.

The website shall clearly identify the commercial activity of the dealer. The dealer shall grant to the final customer all advantages and rights connected to its commercial activity as required by the law (in particular warranty and right of revocation).

The website shall contain information on the responsible provider in accordance with the electronic commerce provisions. Moreover, the dealer shall indicate his valid VAT identification number at a clearly visible location on the website.

To ensure the implementation of the preceding requirements, MARES products shall only be distributed over the internet on the dealer's own website, which shall correspond to these Guidelines. The distribution over so-called internet marketplaces and other distribution platforms of third parties is only permitted if the mentioned presentation criteria are met. The distribution over internet auction platforms which do not comply with this requirement is not permissible. This also applies if the content of the mentioned websites is integrated in the dealer's website by way of "framing". The distribution and offering of MARES products on internet auction platforms in form of a sale by auction is generally not allowed.

In order to avoid any risk of misleading the final customer with regard to the availability of products and to be able to take into account shortfalls in production, as well as for confidentiality reasons with regard to the launch of new products, the dealer shall not announce, present or promote MARES products until prior confirmation by MARES that these products have actually been produced, are available and can be supplied.

The dealer shall notify the distribution over the internet to the MARES distributor without delay and shall, upon request inform and render account to the MARES distributor of all circumstances relevant to the compliance with these Guidelines, including by provision of copies of the relevant documents.

In the country of internet or stationary distribution, the dealer shall either operate a service centre that has been certified by MARES and a corresponding spare parts depot, or conclude a respective agreement with a certified service centre and corresponding spare parts depot. This agreement shall ensure a proper servicing of the MARES products, to avoid any detriment or risks in connection with the use of the respective MARES products by final customers due to improper servicing. The dealer and the service centre are free to agree on the terms of this agreement. The dealer shall indicate the address of the service centre on the website.

The internet dealer shall inform the MARES distributor in advance before starting any business activities in a country, and shall notify the MARES distributor of the certified service centre, as shall refrain from presenting and distributing MARES products without a certified service centre. In this regard, the dealer acknowledges that MARES records the serial number of its products, in order to ensure that all necessary steps can swiftly be taken in case of technical problems. The dealer shall keep detailed records of all serial numbers and addresses of final customers for use in case of product recalls.

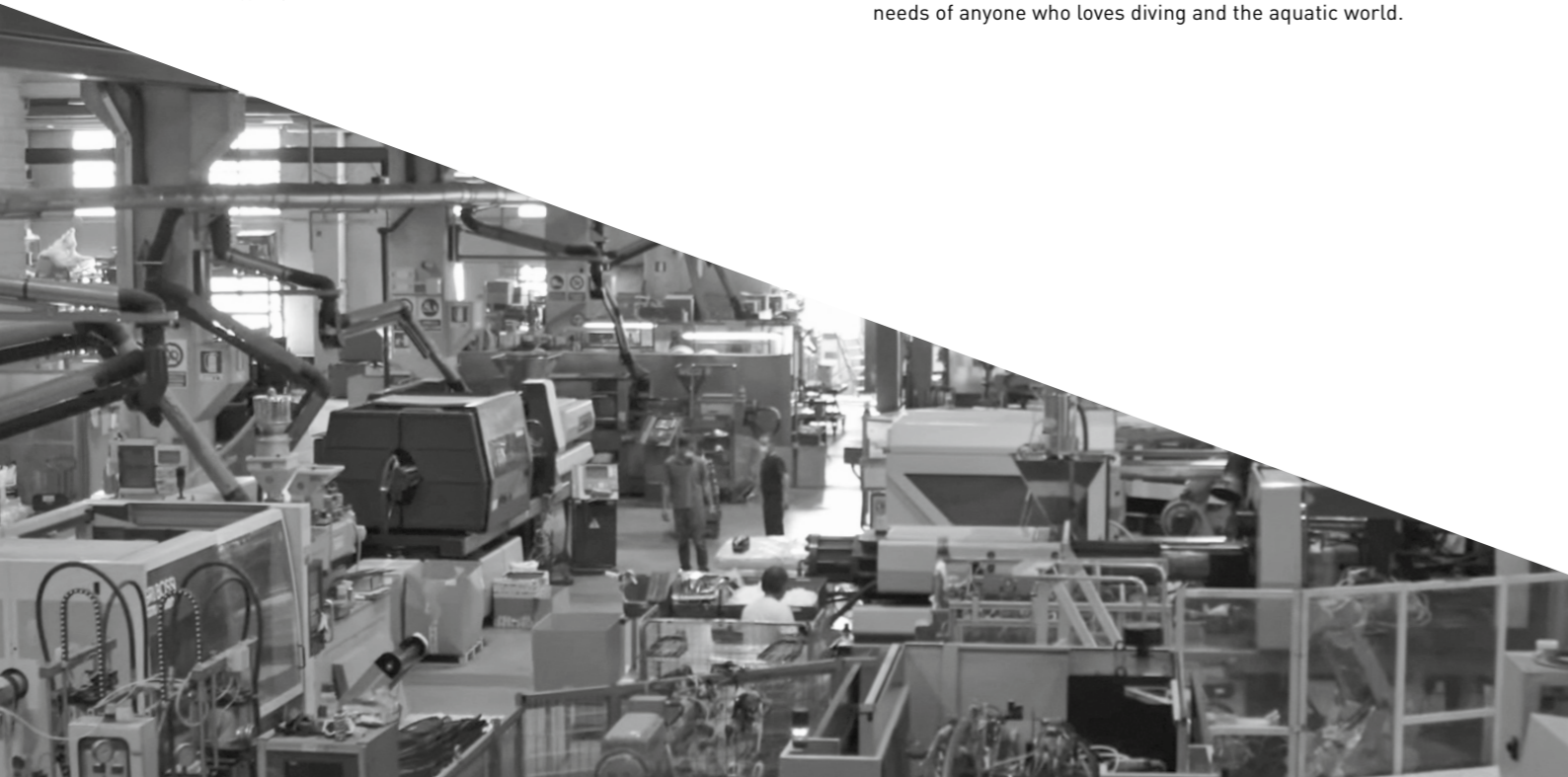

BECAUSE WE CARE

PROTECTING THE OCEAN WITH ECO-FRIENDLY PACKAGING



Over the past four years, Mares has been on a mission to reduce the use of unnecessary plastic in our packaging in an effort to better care for the planet we call home, because if we don't take care of our oceans, who will?

As divers, respecting the ocean is a fundamental rule, but we feel the call to set a higher standard at Mares. We have adopted concrete measures to reduce unnecessary plastic in our company, from removing most of the outer film coatings on our packaging,

to using 100% eco-friendly mask boxes. We also encourage our employees, collaborators, and suppliers to do the same. To safeguard what we love most, we must do our part to preserve all bodies of water now and for future generations.

The initial steps have been taken, with non-plastic alternatives gradually being introduced throughout all our lines, hoping in the near future to replace plastic completely. **Join us in our quest to protect the blue planet.**

SUSTAINABILITY WITHIN THE OFFICE

Mares HQ now uses vending machines with paper cups and wooden spoons. All employees have re-usable water bottles and recycling areas have been placed throughout the office environment.

70

70 YEARS = 70% -
Since Mares hit 70 years in 2019, we have been dedicated to reducing plastic use by 70%.

100%

ECO-FRIENDLY MASK BOX
Mares mask boxes are now molded from sugar cane pulp. Reusable. Recyclable. 100% eco-friendly. Sugar cane pulp is the new cardboard. These new sugar cane fiber-based mask boxes are naturally white, which means no bleaching, and are easier to produce, which lowers water consumption and pollution.



NO PVC

Mares is replacing PVC packaging stickers with paper ones.

I'm green Plastic

GREEN 'BIO-PLASTIC' POLYBAGS

The new way to package all Mares fins and snorkels.



REUSABLE MESH BAGS

Our reusable mesh bags are made from a bio-plastic front panel and a woven R-PET back panel using PET from recycled and transformed plastic bottles. Great for product packaging and reusable for collecting trash while diving.



DURABLE YET SUSTAINABLE

Replacements perform just like standard plastic.

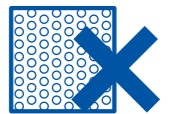

SUSTAINABLE SHIPPING

We are also significantly cutting down the use of plastic when shipping packages, with no more plastic air cushions or bubble wrap used as filling material.



SAY NO TO FILM COATINGS

Mares has removed most of the outer plastic film coatings on our packaging.



CORN-BASED BAGS

The new eco-friendly option for wetsuit packaging.

SAY GOODBYE TO PLASTIC CLAMSHELL PACKAGING

Mares aims to eliminate all plastic clamshell mask packaging.



CO₂ MARES REDUCES ITS ENVIRONMENTAL FOOTPRINT

by using ethanol extracted from sugar cane instead of crude oil for 'bio-plastic' polybags, which significantly reduces carbon emissions.



Since 2007, Mares - as a company of the HEAD Group - has been partnered with global environmental charity Cool Earth. This partnership has resulted in a worldwide environmental program - the first of its kind for a sporting goods company. The simple idea behind Cool Earth is that rainforests are worth much more left standing than they are cut down for timber or burnt to clear land for cattle ranching. Clearing just an acre of rainforest can emit a staggering 260 tonnes of CO₂. Cool Earth works directly with local communities and NGO's around the world to help them protect their forests and halt the impact of deforestation on climate change.

WE SUPPORT COOL EARTH, SO SHOULD YOU.
Go to coolearth.org and learn more about what you can do to help safeguard the planet's essential ecosystems.



MARES S.p.A
Contributed toward saving*:

- 5,495 Kg** Co₂ equivalents
- 2,891 kg** crude oil equivalents
- 1kg** phosphate equivalents
- 268,446 MJ** primary energy
- 9kg** dioxide equivalents

*Eco Certificate 2019 - DerGrünePunkt



NOT JUST A SINGLE PRODUCT, BUT A

COLOR CONCEPT



We are the leader in diving products and will continue to engineer and innovate to ensure that our gear is the best in the underwater world. Mares' philosophy embodies the fact that everyone is different and merits a product line that reflects their passion and confidence, allowing them to perform better and have more fun under the sea. Constant investment in innovation, research, expertise and a creative, professional approach make Mares a synonym of quality, safety and reliability. The best of Mares is encapsulated in every product to meet the needs of each and every diver. Mares products are not just 'single products', but part of a whole concept which allows you to perfectly color coordinate all your dive gear, combining performance and style!



ICONS / GUIDE



TECHNICAL DIVE CONFIGURATION
The particular design, characteristics and elevated performance of this product mean it can also be used in technical dive configurations.



EXTREME COLD WATER
Designing and engineering products for cold water diving requires maximum attention to performance, safety and technical details. Mares creates equipment specific for cold water and ice diving. Rigorous tests ensure top-notch performance keeping you comfortable, warm and secure. Combining comfort, safety and performance is our mission and the strength of our unique R&D Team.



DEEP DIVE
Mares' dedication to research and development is at the heart of our company. Our ANSTI test machine can test down to a depth of 200m, twice the depth of most machines used by our competitors, allowing us to test our regulators in conditions which would be unthinkable for others. With bluetooth, downloading your logbook to a smart device is as simple as pushing a button, no need for cables, cradles or dongles.



TRAVEL OPTIMIZED
In today's world of travel, we are strictly confined by weight restrictions and dimensions. Your equipment needs to include certain features to be considered 'travel friendly'. Lightweight, streamlined, easy to pack and hassle-free are just some of the qualities of our 'Travel Optimized' gear.



LEFT & RIGHT SIDED USE
The innovative design allows you to use the second stage on either the left or right side without having to disassemble the 2nd stage. This design also provides a 2nd stage without a top or bottom. It performs the same in either orientation, making it intuitive and effortless for passing to a buddy. These features, including the technical characteristics, make it very suitable for technical and recreational diving, and for any special operating requirements.



NITROX
All 'Nitrox' version Mares regulators have undergone additional CE testing following norm EN13949:2003. This norm sets out the requirements, tests and labelling for breathing equipment destined for use in open circuit breathing apparatus with compressed Nitrox and Oxygen.



COLOR CUSTOMIZATION
Various color kits available: customize your gear with your preferred color in just a few simple steps.



ULTRASTRETCH
High-end Ultrastretch neoprene delivers the best comfort while diving and during donning and doffing.



FREEDIVING
Accessories and equipment especially designed for freedivers to increase safety, improve hydrodynamics and offer greater comfort.



SPEARFISHING
A full range of accessories and equipment especially designed for spearfishing.



TECH/COMPETITION
Top-level accessories and equipment for demanding divers, competitors and enthusiasts seeking more technical gear.



HIGH POWER
A special speargun configuration which provides maximum power and reliability.



ADVANCED USE
Product designed for advanced use, perfect for snorkelers who need comfort and high performance.



RECREATIONAL USE
Product ideal for recreational use, for those who go snorkeling occasionally.



WATER CONFIDENCE
Product especially developed to improve confidence in the water and introduce little ones to the world of snorkeling.



COLOR & SIZES
The Color & Size identification system allows the user to immediately identify the different sizes of Diving Center and rental equipment by just looking at the color codes.



REGULATORS	8
INSTRUMENTS	35
BCD'S	49
SUITS	63
FINS	99
MASKS & SNORKELS	111
ACCESSORIES	127
JUNIOR LINE	153



BREATHING SYSTEMS	162
BUOYANCY SYSTEMS	173
INSULATION SYSTEMS	191
ACCESSORIES	197



COMPUTERS	208
FINS	211
MASKS & SNORKELS	229
NEOPRENE	237
PNEUMATIC GUNS	257
SLING GUNS	261
ACCESSORIES	273



SEASIDE	302
FINS - ADULT /JUNIOR	312
MASKS & SNORKELS - ADULT /JUNIOR	319
COMBOS - ADULT /JUNIOR	343
SETS - ADULT /JUNIOR	359
NEOPRENE - ADULT /JUNIOR	363



	367
--	-----

PROMO MATERIAL	385
	393



20
23
mares

SCUBA DIVING





REGULATORS



MAIN FEATURES / 1ST STAGES

NATURAL DFC Dynamic Flow Control

All low pressure ports on Mares first stages offer Natural DFC (Dynamic Flow Control) which guarantees elevated, consistent air flow to the second stage, satisfying all the needs of a diver, even the most expert and those who tech dive.

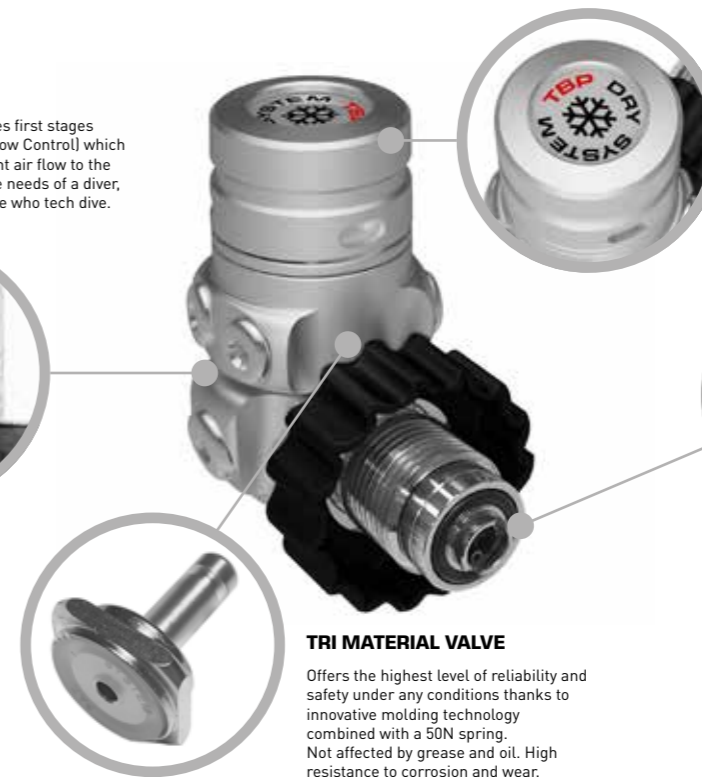

TBP Twin Balanced Piston (optional)

The ultimate solution for extreme cold water. The first stage is completely isolated, guaranteeing the greatest reliability at extreme depths. Phenomenally reactive to pressure variations, it meets the requirements of NORSOK U-101 at a depth of 200m.

TRI MATERIAL VALVE

Offers the highest level of reliability and safety under any conditions thanks to innovative molding technology combined with a 50N spring. Not affected by grease and oil. High resistance to corrosion and wear.

AST Auto Sealing Technology

The AST system is a dynamic technology which provides protection against water entry to the first stage, without affecting the performance of the regulator during use. This Pneumatic solution ensures reliability without compromise. AST is an internal component that is automatically activated by air pressure, thus requiring no action from the diver. It simply opens when the first stage is pressurized, and closes when it is depressurized.

MAIN FEATURES / 2ND STAGES

VAD Vortex Assisted Design

The bypass tube delivers gas to the mouthpiece, creating a swirling vortex with a low pressure area in the center that pushes the diaphragm down during inhalation. For sensitive, natural breathing at all depths.



PAD System Pneumatically Assisted Design

With this system, we have the same pressure on both sides of the second stage valve; the spring tension required to close the valve is greatly reduced. Lower spring tension results in greater comfort during inhalation.

This, combined with the VAD system, results in a high-performing, very comfortable second stage which offers natural breathing.



TPS Twin Power System

A flow control system which manages the delivery rate of gas, from natural breathing to power breathing. The former is the traditional Mares regulator way of breathing (VAD) while the latter (VAD+) provides an extra push when you need it.

ADJ Adjustable Breathing Comfort

Allows the diver to personalise the comfort of their regulator based on personal needs and characteristics - from the diver's own experience to the dive conditions.



DFC / DYNAMIC FLOW CONTROL

The exclusive DFC system is a true innovation in the diving market. It makes it possible to minimize the intermediate pressure drop that occurs in all first stages during the inhalation phase of the divers breathing cycle.

This phenomenon is compounded and noticed more with increasing depth and when the airflow demanded from the regulator is higher. A restriction of the valve pin hole hinders the formation of a dynamic pressure. An additional conduit located between the intermediate pressure chamber and the command spring chamber, leads directly to the LP-port of the second stage, preventing counter-pressure from accumulating. The DFC system uses the Venturi Effect, optimizing the regulator's sensitivity to ensure maximum delivery of air to the second stage during the inhale.

The DFC system substantially reduces inhalation resistance, especially during deep dives and under demanding conditions.

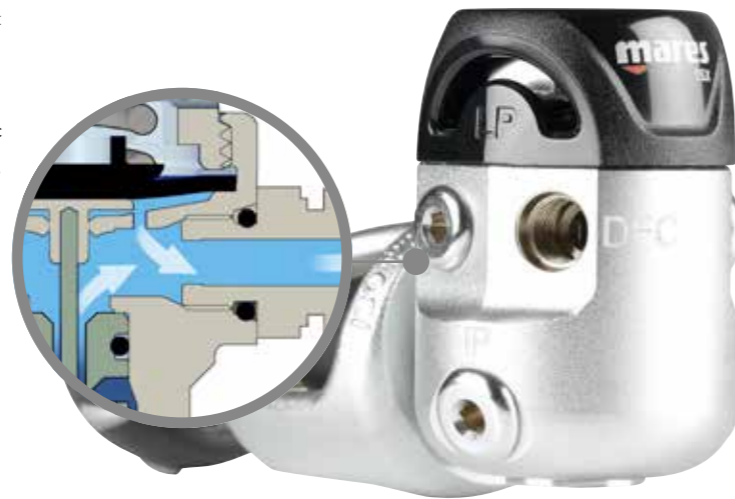

DISCOVER MORE

NO DFC

Equipment	Competitor "A"
Regulator Type	XX 151
Serial Number	10.19 barg
Interstage Pressure Static	
Conditions of Test	Mean
Room Temperature (C)	23.0 C
Exhale Temp (C)	20.4 C
Water Temp (C)	7.7 C
Fast Response Temp Min	9.7 C
Fast Response Temp Max	10.5 C
HP Supply Pressure (barg)	57.3 barg
Tidal Volume (litre)	2.10 litre
Breath Rate (bpm)	25.13 bpm
Ventilation Rate (lpm)	62.89 lpm
Results (2 Loops, SA: 100)	Mean
Inhale Pressure (mbar)	13.59 mbar
Inhale Pos Pressure (mbar)	1.21 mbar
Exhale Pressure (mbar)	9.09 mbar
Ext Work of Breathing (J/l)	1.46 J/l
Inhale Work (J/l)	0.82 J/l
Pos Inhale Work (J/l)	0.00 J/l
Exhale Work (J/l)	0.65 J/l

Pressure-Volume Diagrams at Mean Depth of 50.5 msw (165.8 fsw)

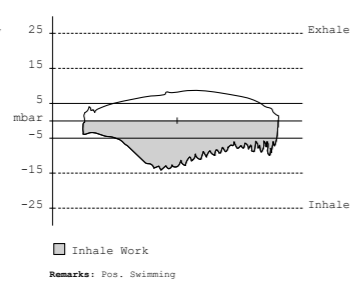

DFC

Equipment	FUSION 72X
Regulator Type	FX 10007
Serial Number	9.74 barg
Interstage Pressure Static	
Conditions of Test	Mean
Room Temperature (C)	23.0 C
Exhale Temp (C)	20.6 C
Water Temp (C)	23.1 C
Fast Response Temp Min	9.7 C
Fast Response Temp Max	10.5 C
HP Supply Pressure	215.7 barg
Tidal Volume (litre)	2.10 litre
Breath Rate (bpm)	25.34 bpm
Ventilation Rate (lpm)	63.3 lpm
Results (2 Loops, SA: 100)	Mean
Inhale Pressure (mbar)	8.31 mbar
Inhale Pos Pressure (mbar)	8.67 mbar
Exhale Pressure (mbar)	11.90 mbar
Ext Work of Breathing (J/l)	0.90 J/l
Inhale Work (J/l)	0.08 J/l
Pos Inhale Work (J/l)	0.21 J/l
Exhale Work (J/l)	0.82 J/l

Pressure-Volume Diagrams at Mean Depth of 50.2 msw (164.8 fsw)

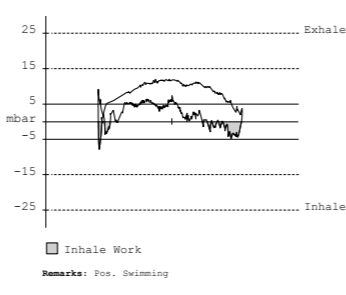

TBP / TWIN BALANCED PISTON

This system consists of a lower piston, sealed by means of an O-ring, on top of which the main spring, which defines intermediate pressure, is placed. Above the spring, an upper piston with the same dimensions as the lower one senses the ambient pressure. This piston is sealed against water by a thin silicone membrane. The two pistons are aligned with one

another. This is very important, as we cannot always be sure that the spring has perfectly parallel surfaces, meaning that during movement the piston could tilt slightly. The result is a dry chamber that is unaffected by depth (tested down to 400m) and protected against water, providing a highly reactive response to gas flow request.

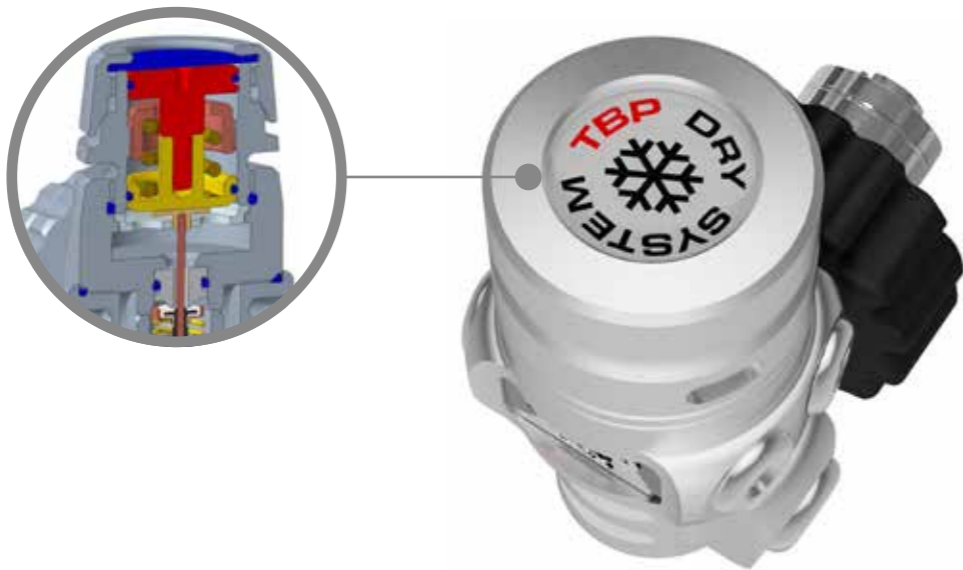

DISCOVER MORE

AST / AUTO SEALING TECHNOLOGY

The AST system is a dynamic technology that provides protection against water leaks into the first stage, without affecting the regulator's performance during use. This pneumatic solution ensures reliability without compromise. AST is an internal component that is activated automatically by the air pressure, requiring no action from the diver. It simply opens when the first stage is pressurized, and closes when it depressurizes.



DISCOVER MORE

VAD / VORTEX ASSISTED DESIGN

Mares second stages feature VAD Technology. This revolutionary patented delivery system creates a low pressure inside the 2nd stage during inhalation.

The gas coming from the LP-hose passes through the second stage valve and is routed directly to the mouthpiece through our Mares patented bypass tube.

Innovative molding technology, allows Mares to achieve special contours of the bypass tube, resulting in a flow of gas that creates a swirling effect or vortex movement. The core of the vortex is a low pressure area that pulls the diaphragm down during the inhalation phase, resulting in a markedly sensitive and easy breathing regulator. Compared with the traditional Venturi effect technology that all other regulators in the market are based on, our ingenious solution has a number of advantages:

- Allows for the feel of natural breathing. You do not have the feeling of air being "injected" into your mouth, as in many other types of second stages.
- The possibility of freezing the 2nd stage mechanical parts in cold water is considerably reduced because the air expansion inside the 2nd stage occurs in the bypass tube, rather than on the mechanical parts. Ultimately minimizing potential free-flow due to freezing. Many models of Mares regulators with VAD 2nd stages are approved and used by Rescue Agencies, Military Divisions, including the U.S. Navy, for dives in extreme conditions and especially cold water.



DISCOVER MORE



TPS / TWIN POWER SYSTEM

We've designed second stages equipped with the Twin Power System (adjustable VAD). This adjustment can be used at any time during the dive, allowing the diver to choose between natural breathing or assisted breathing, which increases gas flow. The result is an increased flowrate with less effort for divers who need to work extra hard, are in a strong current, or are facing extreme conditions.



PAD / PNEUMATICALLY ASSISTED DESIGN

Second stage models featuring the Adjustable Breathing Comfort System also feature the PAD System (Pneumatically Assisted Design); with this system, the low-pressure gas from the first stage is directed through a hole in the center of the second stage valve, until it reaches an air chamber located at the end of the valve. With the same pressure on both sides of the valve, the spring tension required to close the valve

is greatly reduced. Lighter spring tension results in a high comfort during inhalation. This in combination with the 2nd stage VAD which is automatically regulating air flow based on the divers demand, results in a high performance, highly comfortable, and natural breathing 2nd stage!



ADJUSTABLE BREATHING COMFORT

When you combine the Twin Power System with the Adjustable Breathing Comfort System found in some new models, you have maximum control over customizing your regulator to your personal preference while meeting the demands of changing diving conditions.



COLD WATER & EXTREME COLD WATER USE



Designing and engineering products for cold water diving requires maximum attention to performance, safety and technical details. Mares has created dedicated models specifically adapted to cold water and ice diving.

ALL Mares Regulators are tested and certified for cold water use according to rigorous EN250 requirements: 5 minutes at a water temperature between 2°C and 4°C (fresh water), 50 meters depth, 62.5 liters per minute ventilation rate and 300 bar supply pressure dropping to 50 bar over the course of the test.

A more severe test than that specified by EN250 is the one required by the US Navy for cold water use: 30 minutes at -1.8°C / <29°F (salt water), 60 m depth, 62.5 lpm and 170 bar constant supply pressure (maximization of the Joule-Thompson effect).

Only regulators tested by NEDU (the Navy Experimental Diving Unit) under these conditions are allowed to be placed on the ANU (Approved for Navy Use) list.

As the US Navy is already satisfied with the equipment they have, they have not tested and therefore not updated their list in a very long time. Our Abyss 22 Navy II is one of only two regulators on that list.

Mares, however, still replicates the specifications of the NEDU cold water test in our laboratory for the models we place in our "extreme cold water diving" category, which of course includes the Abyss 22 Navy II, but also many more Mares regulator models.

ANSTI MACHINE

Regulator performance is measured using a special machine that simulates the breathing conditions of a diver underwater. With this machine you can measure the inhale and exhale forces in kPa (kilo Pascal), (1kPa = 10cm of water column). Maximum allowable forces according to EC standards are 2.5kPa (equivalent to 25cm of water column) **D**; testing conditions are: depth 50m **C**, breathing rate: 62.5l/min **A**. Breathing work is also measured, under the same conditions. The maximum breathing work allowed by the European standards is 3 Joule/liter **E**. This work represents the actual fatigue resulting from a diver's breathing during the dive. Breathing effort is represented by the area of the breathing curve (pressure-volume curve). The smaller the area of the curve, the lower the breathing effort.

Mares ANSTI testing machine can reach and test at an unprecedented 200m of depth; twice the depth of most machines used by competitors,

allowing us to test our regulators under conditions that are unthinkable for others. Clearly, a diver doesn't push himself to these depths breathing air, but being able to test at these depths teaches us a great deal about how our regulators function at the limit. What's more, our machine is fitted so that it can be supplied with gas from cylinders, and this enables us to certify our regulators at 200m using the right mix for this depth, which is TX6.7/83.3, as defined by British standard BS8547:2016.

CERTIFIED PERFORMANCE at 200m
PROVEN TECHNOLOGY at 400m



Conditions of Test	Mean
Room Temperature (C)	23.0 C
Exhale Temp (C)	20.4 C
Water Temp (C)	7.7 C
Fast Response Temp Min	9.7 C
Fast Response Temp Max	10.5 C
HP Supply Pressure (barg)	57.3 barg
Tidal Volume (litre)	2.50 litre
Breath Rate (bpm)	25.13 bpm
Ventilation Rate (lpm)	62.89 lpm

Results (2 Loops, SA: 100)	Mean
Inhale Pressure (mbar)	13.59 mbar
Inhale Pos Pressure (mbar)	1.21 mbar
Exhale Pressure (mbar)	9.09 mbar
Ext Work of Breathing (J/l)	1.46 J/l
Inhale Work (J/l)	0.81 J/l
Pos Inhale Work (J/l)	0.00 J/l
Exhale Work (J/l)	0.65 J/l

C Pressure - Volume Diagrams at Mean Depth of 50.5 msw (165.8 fsw)

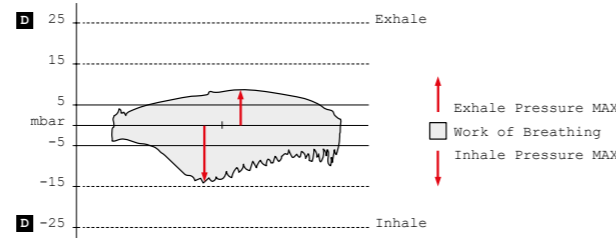

PRODUCT SELECTOR

REGULATORS



	Atlas 62X	Ultra 62X	Epic Adj 82X	Atlas Adj 62X	Abyss 22 Navy II	Ultra Adj 82X	Dual Adj 62X	SXS 62X	Dual 15X	Rover 15X	Rover 25
Code	416273	416272	416247	416268	416171	416250	416271	416269	416258	416254	416255
Page	16	17	18	19	20	22	23	24	25	26	26
Kind of dive & type of use	Technical dive		•			•					
	Deep dive (tested to 200m)	•	•	•	•	•	•	•			
	Cold water	•	•	•	•	•	•	•	•	•	•
	Extreme cold water	•		•	•	•					
	Travel optimized						•	•	•	•	•
1st Stage Details	Dynamic flow control	•	•	•	•	•	•	•	•	•	
	Dry system (AST)	•	•	•	•	•	•	•			
	Twin balanced piston				•						
	360° Swivel turret			•			•				
	Finish	Pearl	Pearl	PVD	Pearl	Sandblasted	Pearl	Pearl	Pearl	Sandblasted	Sandblasted
2nd Stage Details	VAD / Vortex Assisted Design	•			•	•		•	•	•	•
	ADJ VAD / Twin power system		•	•			•				
	Adjustable breathing comfort			•	•		•				
	PAD / Pneumatically assisted			•	•		•				
	Left & right sided use							•			
Material / Technology	All Metal	Ultralight Technopolymer	All Metal	All Metal	All Metal	Ultralight Technopolymer	Ultralight Technopolymer	Ultralight Technopolymer	Ultralight Technopolymer	Ultralight Technopolymer	Ultralight Technopolymer

OCTOPUS



	Atlas	Epic Adj	Atlas Adj	Abyss Navy II	Ultra Adj	Ultra	Dual Adj	SXS	Dual	Loop	Rover
Code	416567	416550	416566	416546	416553	416554	416555	416562	416556	416548	416557
Page	29	29	29	29	29	29	30	30	30	30	30
Kind of dive & type of use	Deep dive (tested to 200m)	•	•	•	•	•	•	•	•	•	•
	Cold water	•	•	•	•	•	•	•	•	•	•
	Extreme cold water	•	•	•	•						
	Travel optimized						•	•	•	•	•
Details	VAD / Vortex Assisted Design	•		•	•		•	•	•	Sagittal	•
	ADJ VAD / Twin power system		•			•					
	Adjustable breathing comfort		•	•		•					
	PAD / Pneumatically assisted		•	•		•					
	Left & right sided use							•		•	
Material / Technology	All Metal	All Metal	All Metal	All Metal	Ultralight Technopolymer	Ultralight Technopolymer	Ultralight Technopolymer	Ultralight Technopolymer	Ultralight Technopolymer	Ultralight Technopolymer	Ultralight Technopolymer

ATLAS 62X

NEW

Code: 416273* INT / DIN 300



2ND STAGE

- ALL METAL TECHNOLOGY FOR BETTER PERFORMANCE, EVEN IN COLD WATER
- EXTREME COLD WATER USE
- VAD SYSTEM FOR NATURAL BREATHING AT ANY DEPTH
- HIGH AIR FLOW
- WIDE, PIVOTING PURGE BUTTON WHICH IS EASY TO USE, EVEN WITH THICK GLOVES
- LIGHTWEIGHT SUPERFLEX HOSE TO ENSURE COMFORT DURING USE

1ST STAGE

- DFC LP PORT FOR HIGH AIR FLOW AT ANY DEPTH
- AST - AUTO SEALING TECHNOLOGY FOR A DRY FIRST STAGE
- PRE-ORIENTED LP AND HP PORTS
- THE MOST COMPACT AND LIGHTWEIGHT MARES DIAPHRAGM 1ST STAGE
- PEARL CHROME FINISH



CERTIFIED PERFORMANCE at 200m
PROVEN TECHNOLOGY at 400m

RESULTS AND PERFORMANCE

Pressure - Volume diagram at mean depth of: 200.8 msw (658.9 fsw)

Inhale Pressure	11.94 Mbar
Inhale Positive Pressure	0.50 Mbar
Exhale Pressure	7.36 Mbar
Work Of Breathing	1.11 J/l
Inhale Work	0.59 J/l
Positive Inhale Work	0.00 J/l
Exhale Work	0.51 J/l

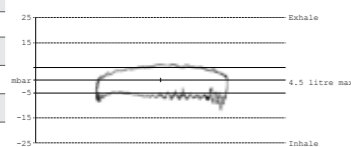

TECHNICAL FEATURES

	INT	DIN 300 bar
1st Stage		
Type	INT	DIN 300 bar
Weight	742g / 26.2oz	525g / 18.5oz
High pressure ports	2 HP 7/16" UNF Ports	
Low pressure ports	4 LP 3/8" UNF Ports	
2nd Stage		
Weight	306g / 10.8oz	
Material/Finish	All Metal Technology / Pearl Chrome	
LP Hose Type/Length	Superflex Hose / 75cm	
Total weight (including hose)	1178g / 41.5oz	961g / 33.9oz

ACCESSORIES

Octopus Atlas	416567	Page 29
DIN Connector	416809	Page 31
Twin Balanced Piston Dry Kit	416819	Page 31
62X	416267	Page 27

DETAILS



AST - First Stage Dry System (DIN version)

Metal Case with VAD System

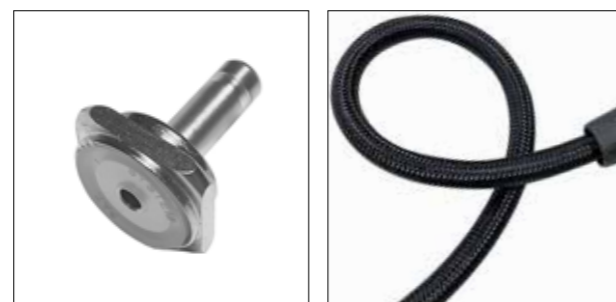

First Stage Valve (#46201816)

Superflex LP hose

*Meets and exceeds the requirements of Norsok U-101 at a depth of 200m

ULTRA 62X

NEW

Code: 416272* INT / DIN 300



2ND STAGE

- TWIN POWER SYSTEM TO CHOOSE BETWEEN NATURAL BREATHING AND ASSISTED BREATHING WITH INCREASED AIR FLOW
- COLD WATER USE
- SECOND STAGE MADE IN ULTRALIGHT, DURABLE TECHNOLOGY
- WIDE, PIVOTING PURGE BUTTON WHICH IS EASY TO USE, EVEN WITH THICK GLOVES
- LIGHTWEIGHT SUPERFLEX HOSE TO ENSURE COMFORT DURING USE
- MI LABELS FOR A UNIQUE LOOK

1ST STAGE

- DFC LP PORT FOR HIGH AIR FLOW AT ANY DEPTH
- AST - AUTO SEALING TECHNOLOGY FOR A DRY FIRST STAGE
- EN 250 COLD WATER CERTIFIED
- PRE-ORIENTED LP AND HP PORTS
- THE MOST COMPACT AND LIGHTWEIGHT MARES DIAPHRAGM FIRST STAGE



CERTIFIED PERFORMANCE at 200m
PROVEN TECHNOLOGY at 400m

RESULTS AND PERFORMANCE

Pressure - Volume diagram at mean depth of: 202.1 msw (663.1 fsw)

Inhale Pressure	11.27 Mbar
Inhale Positive Pressure	0.55 Mbar
Exhale Pressure	7.95 Mbar
Work Of Breathing	0.97 J/l
Inhale Work	0.42 J/l
Positive Inhale Work	0.00 J/l
Exhale Work	0.55 J/l

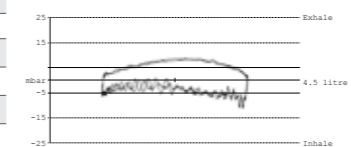

TECHNICAL FEATURES

	INT	DIN 300 bar
1st Stage		
Type	INT	DIN 300 bar
Weight	742g / 26.2oz	525g / 18.5oz
High pressure ports	2 HP 7/16" UNF Ports	
Low pressure ports	4 LP 3/8" UNF Ports	
2nd Stage		
Weight	190g / 6.7oz	
Material/Finish	Ultralight Technopolymer	
LP Hose Type/Length	Superflex Hose / 75cm	
Total weight (including hose)	1068g / 37.7oz	851g / 30oz

ACCESSORIES

Octopus Ultra	416554	Page 29
DIN Connector	416809	Page 31
Twin Balanced Piston Dry Kit	416819	Page 31
62X	416267	Page 27

DETAILS



Twin Power System

All Metal First Stage



Pivoting Purge Button

AST - First Stage Dry System (INT version)

*Meets and exceeds the requirements of Norsok U-101 at a depth of 200m

EPIC ADJ 82X

Code: 416247* INT / DIN 300



2ND STAGE

- METAL 2ND STAGE WITH PVD COATING
- EXTREME COLD WATER USE
- TWIN POWER SYSTEM
- ADJUSTABLE BREATHING COMFORT
- PAD - PNEUMATICALLY ASSISTED DESIGN
- HIGH AIR FLOW
- WIDE PIVOTING PURGE BUTTON
- SUPERFLEX HOSE

1ST STAGE

- PVD COATING
- SWIVEL TURRET
- NATURAL DFC ON ALL LP PORTS
- OPD - TILTED HP PORTS
- AST - 1ST STAGE DRY SYSTEM
- COMPACT DIMENSIONS



CERTIFIED PERFORMANCE at 200m
PROVEN TECHNOLOGY at 400m

RESULTS AND PERFORMANCE

Pressure - Volume diagram at mean depth of: 201.4 msw (660.9 fsw)

Inhale Pressure	8.78 Mbar
Inhale Positive Pressure	2.25 Mbar
Exhale Pressure	9.19 Mbar
Work Of Breathing	1.27 J/l
Inhale Work	0.60 J/l
Positive Inhale Work	0.00 J/l
Exhale Work	0.67 J/l

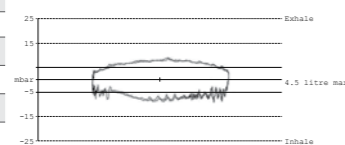

TECHNICAL FEATURES

	INT	DIN 300 bar
1st Stage		
Type	INT	DIN 300 bar
Weight	964g / 34oz	790g / 27.9oz
High pressure ports	2 HP 7/16" UNF Ports	
Low pressure ports	5 LP 3/8" UNF Ports	
2nd Stage		
Weight	329g / 11.6oz	
Material/Finish	All Metal Technology	
LP Hose Type/Length	Superflex Hose / 75cm	
Total weight (including hose)	1429g / 50.4oz	1255g / 44.3oz

ACCESSORIES

Octopus Epic Adj	416550	Page 29
DIN Connector	416809	Page 31
Twin Balanced Piston Dry Kit	416860	Page 31

DETAILS



Swivel Turret - Natural DFC on all LP ports

AST - 1st Stage Dry System [DIN version]

*Meets and exceeds the requirements of Norsok U-101 at a depth of 200m

ATLAS ADJ 62X

Code: 416268* INT / DIN 300



2ND STAGE

- ALL METAL TECHNOLOGY
- EXTREME COLD WATER USE
- VAD SYSTEM FOR NATURAL BREATHING
- ADJUSTABLE BREATHING COMFORT TO FULFIL DIVER'S NEEDS
- PAD - PNEUMATICALLY ASSISTED DESIGN
- WIDE PIVOTING PURGE BUTTON WHICH IS EASY USE, EVEN WITH THICK GLOVES
- HIGH AIR FLOW
- SUPERFLEX HOSE

1ST STAGE

- TBP: ENVIRONMENTALLY SEALED FOR BETTER PERFORMANCE ON COLD WATER DIVES
- DFC LP PORT FOR HIGH AIR FLOW AT ANY DEPTH
- AST - FIRST STAGE DRY SYSTEM TO AVOID WATER ENTERING
- PRE-ORIENTED LP AND HP PORTS
- COMPACT DIAPHRAGM 1ST STAGE
- PEARL CHROME FINISH



CERTIFIED PERFORMANCE at 200m
PROVEN TECHNOLOGY at 400m

RESULTS AND PERFORMANCE

Pressure - Volume diagram at mean depth of: 201.0 msw (659.3 fsw)

Inhale Pressure	14.71 Mbar
Inhale Positive Pressure	2.94 Mbar
Exhale Pressure	9.35 Mbar
Work Of Breathing	1.75 J/l
Inhale Work	1.03 J/l
Positive Inhale Work	0.00 J/l
Exhale Work	0.71 J/l

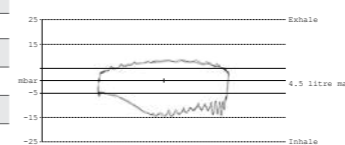

TECHNICAL FEATURES

	INT	DIN 300 bar
1st Stage		
Type	INT	DIN 300 bar
Weight	782g / 27.6oz	565g / 19.9oz
High pressure ports	2 HP 7/16" UNF Ports	
Low pressure ports	4 LP 3/8" UNF Ports	
2nd Stage		
Weight	313g / 11oz	
Material/Finish	All Metal Technology	
LP Hose Type/Length	Superflex Hose / 75cm	
Total weight (including hose)	1225g / 43.2oz	1008g / 35.5oz

ACCESSORIES

Octopus Atlas Adj	416566	Page 29
Twin Balanced Piston Dry Kit	416819	Page 31
DIN Connector	416809	Page 31
Swivel	415862	Page 31

DETAILS



All Metal First Stage

Metal Case with VAD System

*Meets and exceeds the requirements of Norsok U-101 at a depth of 200m

ABYSS 22 NAVY II

Code: 416171 INT / DIN 300



2ND STAGE

- VAD SYSTEM FOR NATURAL BREATHING AT ANY DEPTH
- EXTREME COLD WATER USE
- MESH GRID SYSTEM ON FRONT COVER MINIMIZES FREE FLOW DURING DIVES IN STRONG CURRENTS
- FLUOROPOLYMER RESIN FINISH TO MINIMIZE ICE CRYSTALS
- STURDY, RUBBER LP HOSE

1ST STAGE

- HIGH FLOW DFC LP PORT
- CWD KIT TO OFFER RELIABLE PROTECTION AGAINST ICING UP DURING EXTREME COLD WATER DIVES
- PRE-ORIENTED LP AND HP PORTS
- APPROVED ON THE NAVY ANU LIST IN ACCORDANCE WITH NAVY COLD AND GENERAL WATER TESTING CONDITIONS



TECHNICAL FEATURES

	INT	DIN 300 bar
Type	INT	DIN 300 bar
Weight	850g / 30oz	685g / 24.2oz
High pressure ports	2 HP 7/16" UNF Ports	
Low pressure ports	1 LP 1/2" UNF Port, 3 LP 3/8" UNF Ports	
Weight	269g / 9.5oz	
Material/Finish	All Metal Technology	
LP Hose Type/Length	Rubber hose / 80cm	
Total weight (including hose)	1337g / 47.2oz	1172g / 41.3oz

ACCESSORIES

Octopus Abyss Navy	416546	Page 29
22X DIN Connector	416810	Page 31

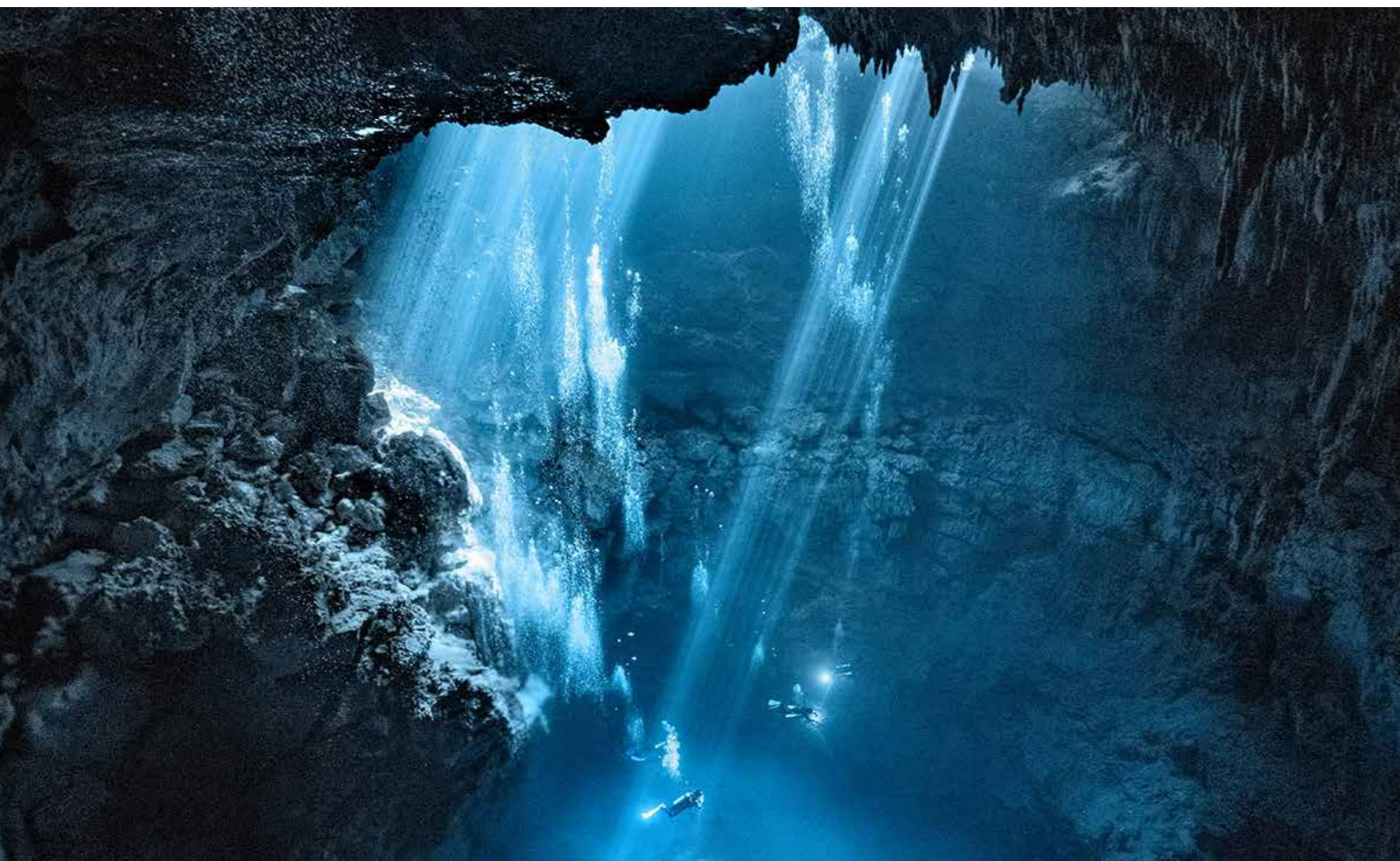

ABYSS 22 NAVY II

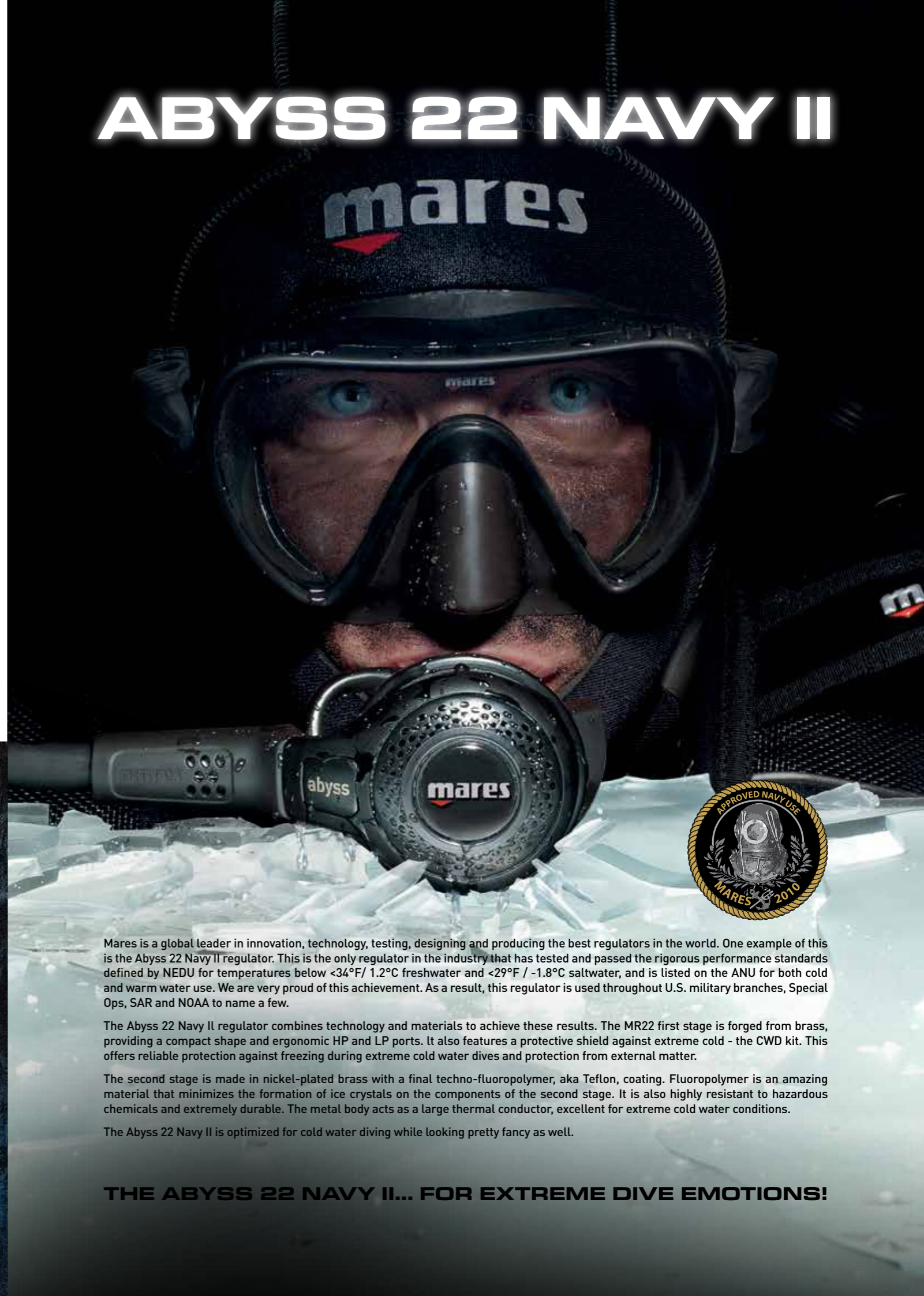

Mares is a global leader in innovation, technology, testing, designing and producing the best regulators in the world. One example of this is the Abyss 22 Navy II regulator. This is the only regulator in the industry that has tested and passed the rigorous performance standards defined by NEDU for temperatures below 34°F / 1.2°C freshwater and 29°F / -1.8°C saltwater, and is listed on the ANU for both cold and warm water use. We are very proud of this achievement. As a result, this regulator is used throughout U.S. military branches, Special Ops, SAR and NOAA to name a few.

The Abyss 22 Navy II regulator combines technology and materials to achieve these results. The MR22 first stage is forged from brass, providing a compact shape and ergonomic HP and LP ports. It also features a protective shield against extreme cold - the CWD kit. This offers reliable protection against freezing during extreme cold water dives and protection from external matter.

The second stage is made in nickel-plated brass with a final techno-fluoropolymer, aka Teflon, coating. Fluoropolymer is an amazing material that minimizes the formation of ice crystals on the components of the second stage. It is also highly resistant to hazardous chemicals and extremely durable. The metal body acts as a large thermal conductor, excellent for extreme cold water conditions.

The Abyss 22 Navy II is optimized for cold water diving while looking pretty fancy as well.

THE ABYSS 22 NAVY II... FOR EXTREME DIVE EMOTIONS!

ULTRA ADJ 82X

Code: 416250* INT / DIN 300



2ND STAGE

- TWIN POWER SYSTEM
- COLD WATER USE
- ADJUSTABLE BREATHING COMFORT
- PAD - PNEUMATICALLY ASSISTED DESIGN
- HIGH AIR FLOW
- ULTRALIGHT TECHNOPOLYMER
- WIDE PIVOTING PURGE BUTTON
- SUPERFLEX HOSE

1ST STAGE

- NATURAL DFC ON ALL LP PORTS
- SWIVEL TURRET
- OPD - TILTED HP PORTS
- AST - 1ST STAGE DRY SYSTEM
- PEARL CHROME FINISH
- COMPACT DIMENSIONS



CERTIFIED PERFORMANCE at 200m
PROVEN TECHNOLOGY at 400m

RESULTS AND PERFORMANCE

Pressure - Volume diagram at mean depth of: 205.8 msw (675.1 fsw)

Inhale Pressure	11.45 Mbar
Inhale Positive Pressure	1.97 Mbar
Exhale Pressure	7.17 Mbar
Work Of Breathing	1.33 J/l
Inhale Work	0.79 J/l
Positive Inhale Work	0.00 J/l
Exhale Work	0.54 J/l

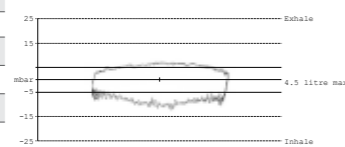

TECHNICAL FEATURES

	INT	DIN 300 bar
1st Stage		
Type	INT	DIN 300 bar
Weight	964g / 34oz	790g / 27.9oz
High pressure ports	2 HP 7/16" UNF Ports	
Low pressure ports	5 LP 3/8" UNF Ports	
2nd Stage		
Weight	192g / 6.8oz	
Material/Finish	Ultralight Technopolymer	
LP Hose Type/Length	Superflex Hose / 75cm	
Total weight (including hose)	1292g / 45.6oz	1118g / 39.4oz

ACCESSORIES

Octopus Ultra Adj	416553	Page 29
82X	416248	Page 27
DIN Connector	416809	Page 31

DETAILS



Adjustable Breathing Comfort

Swivel Turret - Natural DFC on all LP Ports

*Meets and exceeds the requirements of Norsok U-101 at a depth of 200m

DUAL ADJ 62X

Code: 416271* INT / DIN 300



2ND STAGE

- ADJUSTABLE BREATHING COMFORT CAN BE CUSTOMIZED ACCORDING TO THE DIVER'S NEEDS
- COLD WATER USE
- PAD - PNEUMATICALLY ASSISTED DESIGN FOR EXTRA COMFORT DURING INHALATION
- VAD SYSTEM FOR NATURAL BREATHING AT ANY DEPTH
- SECOND STAGE MADE IN ULTRALIGHT TECHNOPOLYMER
- HIGH-QUALITY, OVERSIZED PURGE BUTTON FOR EASY USE WHEN DIVING
- LIGHTWEIGHT SUPERFLEX HOSE TO ENSURE COMFORT DURING USE

1ST STAGE

- AST - AUTO SEALING TECHNOLOGY FOR A DRY FIRST STAGE
- DYNAMIC FLOW CONTROL LP PORT (DFC) FOR HIGH AIR FLOW AT ANY DEPTH
- PRE-ORIENTED LP AND HP PORTS
- NEW COMPACT, LIGHTWEIGHT FIRST STAGE
- PEARL CHROME FINISH



CERTIFIED PERFORMANCE at 200m
PROVEN TECHNOLOGY at 400m

RESULTS AND PERFORMANCE

Pressure - Volume diagram at mean depth of: 202.5 msw (664.3 fsw)

Inhale Pressure	13.46 Mbar
Inhale Positive Pressure	0.57 Mbar
Exhale Pressure	7.25 Mbar
Work Of Breathing	1.53 J/l
Inhale Work	1.01 J/l
Positive Inhale Work	0.00 J/l
Exhale Work	0.52 J/l

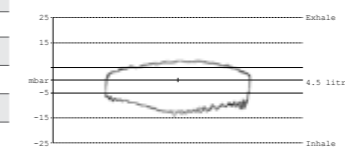

TECHNICAL FEATURES

	INT	DIN 300 bar
1st Stage		
Type	INT	DIN 300 bar
Weight	742g / 26.2oz	525g / 18.5oz
High pressure ports	2 HP 7/16" UNF Ports	
Low pressure ports	4 LP 3/8" UNF Ports	
2nd Stage		
Weight	185g / 6.7oz	
Material/Finish	Ultralight Technopolymer / Pearl Chrome	
LP Hose Type/Length	Superflex Hose / 75cm	
Total weight (including hose)	1057g / 37.3oz	840g / 29.6oz

ACCESSORIES

62X	416267	Page 27
Octopus Dual Adj	416555	Page 30
DIN Connector	416809	Page 31
Twin Balanced Piston Dry Kit	416819	Page 31

DETAILS



Technopolymer Case with Integrated VAD

Bimaterial Purge Button

*Meets and exceeds the requirements of Norsok U-101 at a depth of 200m

SXS 62X

Code: 416269* INT / DIN 300



2ND STAGE

- OUR SMALLEST AND MOST COMPACT SECOND STAGE
- COLD WATER USE
- MADE FROM ULTRALIGHT TECHNOPOLYMER
- VAD SYSTEM WITH „CURVED“ BYPASS FOR THE HIGHEST AIR FLOW
- LEFT AND RIGHT-SIDED USE
- LATERAL EXHAUST TUBE FOR BETTER VISIBILITY IN ALL DIVING POSITIONS
- EASY TO USE, SOFT PURGE BUTTON
- SUPERFLEX HOSE

1ST STAGE

- DFC LP PORT FOR HIGH AIR FLOW AT ANY DEPTH
- PRE-ORIENTED LP AND HP PORTS
- AST - FIRST STAGE DRY SYSTEM TO AVOID WATER ENTRY
- THE MOST COMPACT, LIGHTWEIGHT MARES DIAPHRAGM FIRST STAGE
- PEARL CHROME FINISH



RESULTS AND PERFORMANCE

Pressure - Volume diagram at mean depth of: 204.2 msw (670.1 fsw)

Inhale Pressure	8.90 Mbar
Inhale Positive Pressure	2.54 Mbar
Exhale Pressure	8.66 Mbar
Work Of Breathing	1.21 J/l
Inhale Work	0.53 J/l
Positive Inhale Work	0.00 J/l
Exhale Work	0.68 J/l

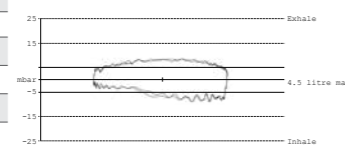

TECHNICAL FEATURES

	INT	DIN 300 bar
1st Stage		
Type	INT	DIN 300 bar
Weight	742g / 26.2oz	525g / 18.5oz
High pressure ports	2 HP 7/16" UNF Ports	
Low pressure ports	4 LP 3/8" UNF Ports	
2nd Stage		
Weight	156g / 5.5oz	
Material/Finish	Ultralight Technopolymer	
LP Hose Type/Length	Superflex Hose / 75cm	
Total weight (including hose)	1028g / 36.3oz	811g / 28.6oz

ACCESSORIES

Octopus SXS	416562	Page 30
DIN Connector	416809	Page 31
Twin Balanced Piston Dry Kit	416819	Page 31
SXS E.T Dry Kit	416820	Page 31

DETAILS



DUAL 15X

Code: 416258 INT / DIN 300



2ND STAGE

- TECHNOPOLYMER
- COLD WATER USE
- LIGHTWEIGHT
- VAD SYSTEM FOR NATURAL BREATHING AT ANY DEPTH
- OVERSIZED SILICONE PURGE BUTTON
- HIGH AIR FLOW
- SUPERFLEX HOSE

1ST STAGE

- DFC PORT
- PRE-ORIENTED PORTS
- COMPACT SIZE
- SANDBLASTED FINISH



TECHNICAL FEATURES

	INT	DIN 300 bar
1st Stage		
Type	INT	DIN 300 bar
Weight	772g / 27.2oz	598g / 21.1oz
High pressure ports	2 HP 7/16" UNF Ports	
Low pressure ports	4 LP 3/8" UNF Ports	
2nd Stage		
Weight	183g / 6.4oz	
Material/Finish	Ultralight Technopolymer	
LP Hose Type/Length	Superflex Hose / 75cm	
Total weight (including hose)	1085g / 70oz	911g / 32.1oz

ACCESSORIES

Octopus Dual	416556	Page 30
15X	416237	Page 27
DIN Connector	416809	Page 31
Twin Balanced Piston Dry Kit	416813	Page 31



*Meets and exceeds the requirements of Norsok U-101 at a depth of 200m

ROVER 15X

Code: 416254 INT / DIN 300



2ND STAGE

- EASY-TO-USE PURGE BUTTON WITH DYNAMIC HINGE DESIGN
- COLD WATER USE
- VAD SYSTEM WITH FLUID DYNAMIC DEFLECTOR
- MID-SIZE
- OVERSIZED PURGE BUTTON
- RUBBER HOSE

1ST STAGE

- DFC PORT
- PRE-ORIENTED PORTS
- COMPACT SIZE
- SANDBLASTED FINISH



TECHNICAL FEATURES

	INT	DIN 300 bar
1st Stage		
Type	INT	DIN 300 bar
Weight	772g / 27.2oz	598g / 21.1oz
High pressure ports	2 HP 7/16" UNF Ports	
Low pressure ports	4 LP 3/8" UNF Ports	
2nd Stage		
Weight	190g / 6.7oz	
Material/Finish	Ultralight Technopolymer	
LP Hose Type/Length	Rubber hose / 80cm	
Total weight (including hose)	1107g / 39oz	933g / 32.9oz

ACCESSORIES

Accessories	Code	Page
15X	416237	Page 27
Octopus Rover	416557	Page 30
DIN Connector	416809	Page 31

ROVER 2S

Code: 416255 INT / DIN 300



2ND STAGE

- EASY-TO-USE PURGE BUTTON WITH DYNAMIC HINGE DESIGN
- COLD WATER USE
- VAD SYSTEM WITH FLUID DYNAMIC DEFLECTOR
- MID-SIZE
- OVERSIZED PURGE BUTTON
- RUBBER HOSE

1ST STAGE*

- LIGHTWEIGHT, STURDY AND COMPACT
- PISTON CONTROL
- DEDICATED PLACE FOR RFID CHIP



TECHNICAL FEATURES

	INT	DIN 300 bar
1st Stage		
Type	INT	DIN 300 bar
Weight	608g / 21.4oz	432g / 15.2oz
High pressure ports	1 HP 7/16" UNF Port	
Low pressure ports	4 LP 3/8" UNF Ports	
2nd Stage		
Weight	190g / 6.7oz	
Material/Finish	Ultralight Technopolymer	
LP Hose Type/Length	Rubber hose / 80cm	
Total weight (including hose)	977g / 34.5oz	978g / 34.5oz

ACCESSORIES

Accessories	Code	Page
2S	416232	Page 27
Octopus Rover	416557	Page 30
DIN Connector	416809	Page 31

82X

Code: 416248

- SWIVEL TURRET
- COLD WATER USE
- NATURAL DFC ON ALL LP PORTS
- OPD - TILTED HP PORTS
- AST - 1ST STAGE DRY SYSTEM
- COMPACT DIMENSIONS
- CERTIFIED WITH ULTRA ADJ AND EPIC ADJ SECOND STAGES AND ALL OCTOPUS MODELS



TECHNICAL FEATURES

	INT	DIN 300 bar
1st Stage		
Type	INT	DIN 300 bar
Weight	964g / 34oz	790g / 27.9oz
High pressure ports	2 HP 7/16" UNF ports	
Low pressure ports	5 LP 3/8" UNF ports	

15X

Code: 416237

- SIMPLE, RUGGED, AND COMPACT
- COLD WATER USE
- CHROME-PLATED BRASS BODY WITH SANDBLASTED FINISH
- 4 PRE-ORIENTED LOW-PRESSURE PORTS, ONE OF WHICH OFFERS DFC.
- CERTIFIED WITH DUAL ADJ, DUAL, LOOP AND ROVER SECOND STAGES AND ALL OCTOPUS MODELS



TECHNICAL FEATURES

	INT	DIN 300 bar
1st Stage		
Type	INT	DIN 300 bar
Weight	772g / 27.2oz	598g / 21.1oz
High pressure ports	2 HP 7/16" UNF ports	
Low pressure ports	4 LP 3/8" UNF ports	

62X

Code: 416267 INT / DIN 300

- DFC ON DEDICATED LP PORT
- COLD WATER USE
- PRE-ORIENTED LP AND HP PORTS
- AST - 1ST STAGE DRY SYSTEM
- LIGHT, COMPACT DIAPHRAGM 1ST STAGE
- CERTIFIED WITH ATLAS, ULTRA, DUAL ADJ, DUAL AND SXS SECOND STAGES AND ALL OCTOPUS MODELS



TECHNICAL FEATURES

	INT	DIN 300 bar
1st Stage		
Type	INT	DIN 300 bar
Weight	638g / 22.5oz	464g / 16.4oz
High pressure ports	2 HP 7/16" UNF Ports	
Low pressure ports	4 LP 3/8" UNF Ports	

2S

Code: 416232

- LIGHTWEIGHT, STURDY AND COMPACT
- COLD WATER USE
- PISTON CONTROL
- DEDICATED PLACE FOR RFID CHIP
- CERTIFIED WITH DUAL, ROVER AND LOOP SECOND STAGES AND ABYSS NAVY, SXS, LOOP AND ROVER OCTOPUS MODELS



TECHNICAL FEATURES

	INT	DIN 300 bar	NX
1st Stage			
Type	INT	DIN 300 bar	NX
Weight	608g / 21.4oz	432g / 15.2oz	-
High pressure ports	1 HP 7/16" UNF port		
Low pressure ports	4 LP 3/8" UNF ports		

*Picture not to scale

*For use with octopuses and 2nd stages with which it has been certified. Assembly, checks and any necessary adjustments must be done by a Mares Lab Authorized Service Center.

DUAL ADJ

Code: 416564*



- ADJUSTABLE BREATHING COMFORT TO FULFIL DIVER'S NEEDS
- COLD WATER USE
- PAD - PNEUMATICALLY ASSISTED DESIGN
- VAD SYSTEM FOR NATURAL BREATHING AT ANY DEPTH
- HIGH AIR FLOW
- MADE FROM ULTRALIGHT TECHNOLOGY
- OVERSIZED PURGE BUTTON WHICH IS EASY TO USE WITH GLOVES
- CERTIFIED WITH 62X AND 15X FIRST STAGES
- 75CM SUPERFLEX LP HOSE INCLUDED



TECHNICAL FEATURES

Weight	185g / 16.5oz
Material	Ultralight Technopolymer
LP Hose Type/Length	Superflex Hose

LOOP

Code: 416563*



- CAN BE MOUNTED ON THE RIGHT OR LEFT SIDE
- COLD WATER USE
- "UNDER THE SHOULDER" HOSE POSITION
- FREEDOM OF MOVEMENT IN ALL DIRECTIONS
- TWIN EXHAUST VALVES
- INTEGRATED SAGITTAL VAD (S-VAD)
- OVERSIZED SILICONE PURGE BUTTON
- CERTIFIED WITH 15X AND 2S FIRST STAGES
- 110CM RUBBER LP HOSE INCLUDED



TECHNICAL FEATURES

Weight	199g / 7oz
Material	Ultralight Technopolymer
LP Hose Type/Length	Rubber hose

DUAL

Code: 416565*



- MADE FROM ULTRALIGHT TECHNOLOGY
- COLD WATER USE
- VAD SYSTEM FOR NATURAL BREATHING AT ANY DEPTH
- OVERSIZED PURGE BUTTON WHICH IS EASY TO USE WITH GLOVES
- HIGH AIR FLOW
- CERTIFIED WITH 62X, 15X AND 2S FIRST STAGES
- 75CM SUPERFLEX LP HOSE INCLUDED



TECHNICAL FEATURES

Weight	183g / 6.4oz
Material	Ultralight Technopolymer
LP Hose Type/Length	Superflex Hose

OCTOPUS ATLAS

NEW

Code: 416567



- ALL METAL TECHNOLOGY FOR BETTER PERFORMANCE, EVEN IN COLD WATER
- EXTREME COLD WATER USE
- VAD SYSTEM FOR NATURAL BREATHING AT ANY DEPTH
- HIGH AIR FLOW
- WIDE PIVOTING PURGE BUTTON WHICH IS EASY TO USE, EVEN WITH THICK GLOVES
- LIGHTWEIGHT SUPERFLEX HOSE TO ENSURE COMFORT DURING USE



OCTOPUS ATLAS ADJ

Code: 416566



- ALL METAL TECHNOLOGY
- EXTREME COLD WATER USE
- VAD SYSTEM FOR NATURAL BREATHING
- ADJUSTABLE BREATHING COMFORT TO FULFIL DIVER'S NEEDS
- PAD - PNEUMATICALLY ASSISTED DESIGN
- WIDE PIVOTING PURGE BUTTON WHICH IS EASY TO USE, EVEN WITH THICK GLOVES
- HIGH AIR FLOW
- SUPERFLEX OCTOPUS HOSE



OCTOPUS ULTRA ADJ

Code: 416553



- TWIN POWER SYSTEM
- COLD WATER USE
- ADJUSTABLE BREATHING COMFORT
- PAD - PNEUMATICALLY ASSISTED DESIGN
- HIGH AIR FLOW
- ULTRALIGHT TECHNOLOGY 2ND STAGE
- WIDE PIVOTING PURGE BUTTON
- SUPERFLEX HOSE



OCTOPUS EPIC ADJ

Code: 416550



- METAL 2ND STAGE WITH PVD COATING
- EXTREME COLD WATER USE
- TWIN POWER SYSTEM
- ADJUSTABLE BREATHING COMFORT
- PAD - PNEUMATICALLY ASSISTED DESIGN
- HIGH AIR FLOW
- WIDE PIVOTING PURGE BUTTON
- SUPERFLEX HOSE



OCTOPUS ABYSS NAVY

Code: 416546



- VAD SYSTEM
- EXTREME COLD WATER USE
- MESH GRID
- FLUOROPOLYMER RESIN FINISH
- RUBBER HOSE



OCTOPUS ULTRA

Code: 416554



- TWIN POWER SYSTEM
- COLD WATER USE
- TECHNOLOGY
- ULTRALIGHT
- WIDE PIVOTING PURGE BUTTON
- HIGH AIR FLOW
- SUPERFLEX HOSE



*Assembly, checks and any necessary adjustments must be done by a Mares Lab Authorized Service Center.

OCTOPUS DUAL ADJ

Code: 416555



- ADJUSTABLE BREATHING COMFORT
- COLD WATER USE
- PAD - PNEUMATICALLY ASSISTED DESIGN
- VAD SYSTEM FOR NATURAL BREATHING AT ANY DEPTH
- HIGH AIR FLOW
- TECHNOPYLIMER
- ULTRALIGHT
- OVERSIZED PURGE BUTTON
- SUPERFLEX HOSE



OCTOPUS SXS

Code: 416562



- OUR SMALLEST, MOST COMPACT SECOND STAGE
- COLD WATER USE
- MADE FROM ULTRALIGHT TECHNOPYLIMER
- VAD. SYSTEM WITH „CURVED“ BYPASS FOR THE HIGHEST AIR FLOW
- LEFT AND RIGHT-SIDED USE
- LATERAL EXHAUST TUBE FOR BETTER VISIBILITY IN ALL DIVING POSITIONS
- EASY TO USE, SOFT PURGE BUTTON
- SUPERFLEX HOSE



OCTOPUS DUAL

Code: 416556



- TECHNOPYLIMER
- COLD WATER USE
- LIGHTWEIGHT
- VAD SYSTEM FOR NATURAL BREATHING AT ANY DEPTH
- OVERSIZED PURGE BUTTON
- HIGH AIR FLOW
- SUPERFLEX HOSE



OCTOPUS LOOP

Code: 416548



- CAN BE MOUNTED ON THE RIGHT OR THE LEFT SIDE
- COLD WATER USE
- FREEDOM OF MOVEMENT IN ALL DIRECTIONS
- "UNDER THE SHOULDER" HOSE POSITION
- TWIN EXHAUST VALVES
- INTEGRATED SAGITTAL VAD (S-VAD)
- OVERSIZED SILICONE PURGE BUTTON



OCTOPUS ROVER

Code: 416557



- EASY-TO-USE PURGE BUTTON WITH DYNAMIC HINGE DESIGN
- COLD WATER USE
- VAD SYSTEM WITH FLUID DYNAMIC DEFLECTOR
- MID-SIZE
- OVERSIZED PURGE BUTTON
- RUBBER HOSE



CERTIFIED OCTOPUS/1ST STAGE COMBINATIONS

	1ST STAGES			
	82X	62X	15X	2S
ATLAS	■	■	■	
EPIC ADJ	■	■	■	
ATLAS ADJ	■	■	■	
ABYSS NAVY	■	■	■	■
ULTRA ADJ	■	■	■	
ULTRA	■	■	■	
DUAL ADJ	■	■	■	
SXS	■	■	■	■
DUAL	■	■	■	
LOOP	■	■	■	■
ROVER	■	■	■	■

DIN CONNECTOR

Code: 416809 for 82X - 62X - 15X - 2S

Code: 416810 for 22X

Code: 416817 for 82X - 62X - 15X - 2S with AST

- FOR 200 AND 300 BAR USE
- CONICAL SINTERED FILTER
- AST - AUTO SEALING TECHNOLOGY (416817)



416809
416817

416810

AST DRY SYSTEM

Code: 416811 INT

Code: 416812 DIN

- AUTO-SEALING TECHNOLOGY
- KEEPS THE 1ST STAGE DRY
- ACTIVATED BY GAS
- CAN BE USED WITH A HIGHER PERCENTAGE OF OXYGEN
- CAN BE USED IN COLD WATER
- CAN BE INSTALLED ON 82X-62X-15X AND 2S 1ST STAGES



SXS E.T. DRY KIT

Code: 416820

- INNOVATIVE, MULTIPURPOSE KIT FOR SXS SECOND STAGES
- TWIN EXHAUST VALVE SYSTEM
- SMART SOLUTION TO MAKE THE SECOND STAGE TOTALLY DRY
- BEST PERFORMANCE FOR EXTREME COLD WATER DIVES
- EXTENSION TUBE DRY KIT
- NO BUBBLES IN FRONT OF THE DIVER'S FACE FOR AN UNPARALLELED FIELD OF VISION DURING A DIVE



NEW

TWIN BALANCED PISTON DRY KIT

Code: 416860 for 82X

Code: 416819 for 62X

Code: 416813 for 15X

- RECOMMENDED FOR USE IN ALL COLD WATER CONDITIONS, EVEN THE MOST EXTREME
- IDEAL FOR CONTAMINATED WATER
- HIGH FLOW PERFORMANCE
- PROTECTS ALL MOVING PARTS



82X

62X

15X

SWIVEL

Code: 415862

- TO IMPROVE COMFORT
- 120 DEGREE ADAPTER
- EASY TO INSTALL BETWEEN HOSE AND 2ND STAGE
- 9/16" UNF



DIN/YOKE ADAPTOR

Code: 415861

- FOR ALL DIN 1ST STAGES



JAX

Code: **415336 12 pcs mix (2 pcs BL/YL/BK/CL - 1 pcs GN/PK/IYL/WH)**

Code: **415347 12 pcs unicolors (CL/BK/PK/BL/YL)**

- CUSTOM FIT MOUTHPIECE
- VARIOUS COLOR OPTIONS
- HIGH COMFORT
- FITS ON ALL MARES REGULATORS
- STRAP INCLUDED



REGULAR MOUTHPIECE KIT

Code: **415335**

- THE STANDARD MARES MOUTHPIECE
- STRAP INCLUDED
- FITS ON ALL MARES REGULATORS



SMALL MOUTHPIECE KIT

Code: **415111**

- SMALL SIZE MARES MOUTHPIECE
- STRAP INCLUDED
- FITS ON ALL MARES REGULATORS



LP HOSES

	LP HOSE WITHOUT HOSE PROTECTORS						1 ST STAGE	2 ND STAGE
						HOSE PROTECTORS	HOSE PROTECTORS	
REGULATORS	Abyss 22 Navy	46201396	1/2"	RUBBER	BLACK	80 cm		46200846
	Epic Adj 82X							46201313
	Ultra Adj 82X							46201313
	Ultra 62X							46201313
	Atlas Adj 62X	46201379	3/8"	SUPERFLEX	BLACK	75 cm	46201249	46201473
	Atlas 62X							46201473
	Dual Adj 62X							46201473
	SXS 62X							46201473
Dual 15X							46201473	
Rover 15X / Rover 25	46201382	3/8"	RUBBER	BLACK	80 cm		46201473	
OCTOPUS	Epic Adj							46201339
	Ultra Adj							46201339
	Ultra							46201339
	Atlas Adj	46201381	3/8"	SUPERFLEX	YELLOW	100 cm	46201249	46201473
	Atlas							46201473
	Dual Adj							46201473
	SXS							46201473
	Dual							46201473
	Abyss Navy	46201383	3/8"	RUBBER	YELLOW	100 cm		46200846
	Rover							46201473
Loop	46201666	3/8"	RUBBER	YELLOW	110 cm		46201473	

SPECIAL LENGTH						
Regulator hose	46200984	3/8"	SUPERFLEX	BLACK	210 cm	
	46200985	1/2"	SUPERFLEX	BLACK	210 cm	
	46200986	3/8"	SUPERFLEX	YELLOW	210 cm	
	46201393	3/8"	RUBBER	BLACK	210 cm	
	46201394	3/8"	RUBBER	BLACK	60 cm	

1ST STAGES

2ND STAGES



- 82X PVD**
- Balanced diaphragm design
 - Swivel turret
 - 2 HP 7/16" UNF ports
 - 5 LP 3/8" UNF ports



Epic Adj



- 82X**
- Balanced diaphragm design
 - Swivel turret
 - 2 HP 7/16" UNF ports
 - 5 LP 3/8" UNF ports



Ultra Adj



- 62X TBP**
- Balanced diaphragm design
 - 2 HP 7/16" UNF ports
 - 4 LP 3/8" UNF ports



Atlas Adj



- 62X**
- Balanced diaphragm design
 - 2 HP 7/16" UNF ports
 - 4 LP 3/8" UNF ports



Atlas

Ultra

SXS

Dual Adj



- 22X CWD KIT**
- Balanced diaphragm design
 - 2 HP 7/16" UNF ports
 - 1 LP 1/2" UNF port (primary)
 - 3 LP 3/8" UNF ports



Abyss Navy II



- 15X**
- Balanced diaphragm design
 - 2 HP 7/16" UNF ports
 - 4 LP 3/8" UNF ports



Dual

Rover



- 2S**
- Piston design
 - 1 HP 7/16" UNF port
 - 4 LP 3/8" UNF ports



Rover

REGULATORS



Regulators	Atlas 62X	Ultra 62X	Epic Adj 82X	Atlas Adj 62X	Abyss 22 Navy II	Ultra Adj 82X	Dual Adj 62X	SXS 62X	Dual 15X	Rover 15X	Rover 2S	
Code	416273	416272	416247	416268	416171	416250	416271	416269	416258	416254	416255	
1st Stage	Diaphragm Piston	■	■	■	■	■	■	■	■	■	■	
All Metal Technology	■		■	■	■							
Ultralight Techno Polymer		■				■	■	■	■	■	■	
DFC - Dynamic Flow Control	■	■	■	■	■	■	■	■	■	■	■	
AST - Auto Sealing Technology	■	■	■	■	■	■	■	■	■	■	■	
Swivel Turret			■									
Tilted HP			■									
Twin Power		■	■									
VAD - Vortex Assisted Design	■	■	■	■	■	■	■	■	■	■	■	
Adjustable Breathing Comfort			■	■	■	■	■	■	■	■	■	
PAD Pneumatically Assisted Design			■	■	■	■	■	■	■	■	■	
Mesh Grid										■	■	
Fluid Dynamic Deflector										■	■	
Superflex Hose		■	■	■	■	■	■	■	■	■	■	
PVD finishing			■									
Pearl finishing	■			■	■	■	■	■	■	■	■	
Sandblasted												
1st Stage Weight	INT DIN 300 bar	742g / 26.2oz 525g / 18.5oz	742g / 26.2oz 525g / 18.5oz	964g / 34oz 790g / 27.9oz	782g / 27.6oz 565g / 19.9oz	850g / 30oz 685g / 24.2oz	964g / 34oz 790g / 27.9oz	742g / 26.2oz 525g / 18.5oz	742g / 26.2oz 525g / 18.5oz	772g / 27.2oz 598g / 21.1oz	772g / 27.2oz 598g / 21.1oz	608g / 21.4oz 432g / 15.2oz
2nd Stage Weight		306g / 10.8oz	190g / 6.7oz	329g / 11.6oz	313g / 11oz	269g / 9.5oz	192g / 6.8oz	185g / 6.7oz	156g / 5.5oz	183g / 6.4oz	190g / 6.7oz	190g / 6.7oz
Total Weight (including hose)	INT DIN 300 bar	1178g / 41.5oz 961g / 33.9oz	1068g / 37.7oz 851g / 30oz	1429g / 50.4oz 1255g / 44.3oz	1225g / 43.2oz 1008g / 35.5oz	1337g / 47.2oz 1172g / 41.3oz	1292g / 45.6oz 1118g / 39.4oz	1057g / 37.3oz 840g / 29.6oz	1028g / 36.3oz 811g / 28.6oz	1085g / 70oz 911g / 32.1oz	1107g / 39oz 933g / 32.9oz	977g / 34.5oz 978g / 34.5oz



2023

OCTOPUS



Octopus	Atlas	Epic Adj	Atlas Adj	Abyss Navy II	Ultra Adj	Ultra	Dual Adj	SXS	Dual	Loop	Rover
Code	416567	416550	416566	416546	416553	416554	416555	416562	416556	416548	416557
All Metal Technology	■	■	■	■							
Ultralight Techno Polymer					■	■	■	■	■	■	■
Twin Power		■			■	■	■	■	■	■	■
VAD - Vortex Assisted Design	■	■	■	■	■	■	■	■	■	Sagittal	■
Adjustable Breathing Comfort		■	■	■	■	■	■	■	■		
Pneumatically Balanced System		■	■	■	■	■	■	■	■		
Mesh Grid				■							
Fluid Dynamic Deflector											■
Superflex Hose	■	■	■	■	■	■	■	■	■	■	■
Total Weight (including hose)	436g / 15.4oz	483g / 17oz	443g / 15.6oz	427g / 15.1oz	346g / 12.2oz	344g / 12.1oz	359g / 12.7oz	286g / 10.1oz	357g / 12.6oz	374g / 13.2oz	365g / 12.9oz

INSTRUMENTS



INSTRUMENTS ICONS / GUIDE



GRADIENT FACTORS

Gradient factors were developed by tech divers to render the ZH-L16C algorithm the most advanced decompression tool capable of tackling the most demanding dives. Gradient factors are also a very intuitive and transparent way to customize the algorithm to one's personal needs, making it the most universal and powerful algorithm in existence today.



AGF ALTERNATE GRADIENT FACTORS

Alternate Gradient Factors are an additional, less restrictive decompression plan, calculated throughout the dive, that a diver can switch to in case of an emergency. This second decompression calculation can be displayed together with the main gradient factors calculation for an assessment of the situation.



CEIL-CON

Ceiling-controlled decompression (CEIL-CON) maximizes inert gas washout by leading you through a continuous, controlled ascent in between the standard 3 m / 10 ft decompression steps. This results in shortened decompression times and smoother supersaturation profiles in your tissues.



TRIMIX

The Mares implementation of ZH-L16C GF allows for up to 5 gases with trimix and heliox, including hypoxic mixes down to 7% oxygen concentration, and nitrox up to 99% oxygen concentration.



PREDICTIVE MULTIGAS

The Predictive Multigas feature allows you to perform gas switches during the dive to accelerate your decompression. The predictive decompression feature, if activated, ensures that all set gases are accounted for in the decompression calculation, allowing you to take full advantage of the extra tanks that you carry along with you.



BLUETOOTH

Bluetooth accompanies us in our daily life and it is only natural that this technology trickled down to dive computers. With bluetooth, downloading your logbook to a smart device is as simple as pushing a button, no need for cables, cradles or dongles.



DIGITAL COMPASS

A compass should always be part of a diver's equipment, even if you don't use it on a regular basis. So having it integrated within your dive computer is the most logical solution. With a digital compass you can set a bearing to navigate to a wreck, swim in blue water towards the beach after a deep canyon dive, and much more. Or simply know that it is there, in case you need it.



RECHARGEABLE BATTERY

Mares presented the first dive computer with a rechargeable battery in 2010. This technology has made giant strides since then, and Mares has participated in this evolution step-by-step, as exemplified with induction charging for Sirius.



TFT COLOR DISPLAY

Color displays are so much more than a gimmick when it comes to diving. A dive computer is not only a depth gauge and decompression meter, but also your guardian should a dangerous situation arise. Genius can alert you in clear text, in one of 17 languages, combining the text with color to highlight the situation and how to correct it, so that you should be in no doubt as to what action to take to remedy the situation. Having a smartphone type user interface, including graphic dive logs, is an added bonus.



MIP COLOR DISPLAY

MIP (Memory In Pixel) is a new technology that allows for super high efficiency in a color display. In addition to very high contrast, these displays are amazing for how little energy they consume, allowing Sirius to function as a watch for 10 days and as a dive computer for more than 30* 1-hour dives (the number of dives per charge depends strongly on the use of the backlight and, to a lesser extent, on water temperature).

* without tank data integration (20 hours with tank data integration)



HOSELESS TANK DATA INTEGRATION

What is better than a pressure gauge on a hose? A pressure gauge without a hose, even better if it is embedded in the display of your dive computer. Using patented radio-frequency technology, the Mares Tank Module transmits encrypted tank information at regular intervals that only a specific dive computer can read, so you can dive with peace of mind, even in a group of divers using the same technology.

MARES APP 1.0



- STARTING PAGE FOR INTUITIVE USER EXPERIENCE
- STATE-OF-THE-ART LOGBOOK FUNCTIONS, INCLUDING GRAPHICS, FOR SCUBA, EXTENDED RANGE AND FREDIVING
- IN-APP COMMUNICATION DESIGNED TO SUPPORT CUSTOMER RETENTION
- SSI & MARES VERSION ARE VERY SIMILAR
- LATEST "HYBRID" PROGRAMMING TO ENHANCE PERFORMANCE AND SECURITY

FUNCTION OVERVIEW:

- HOME / START PAGE
- QR CODE
- LOGBOOK
- BUDDIES
- LOCATIONS
- NEWS & VIDEOS
- GEAR
- INSURANCE
- TABLES & CUE CARDS
- WILDLIFE
- FIRMWARE
- PROFILE & PRIVACY SETTINGS

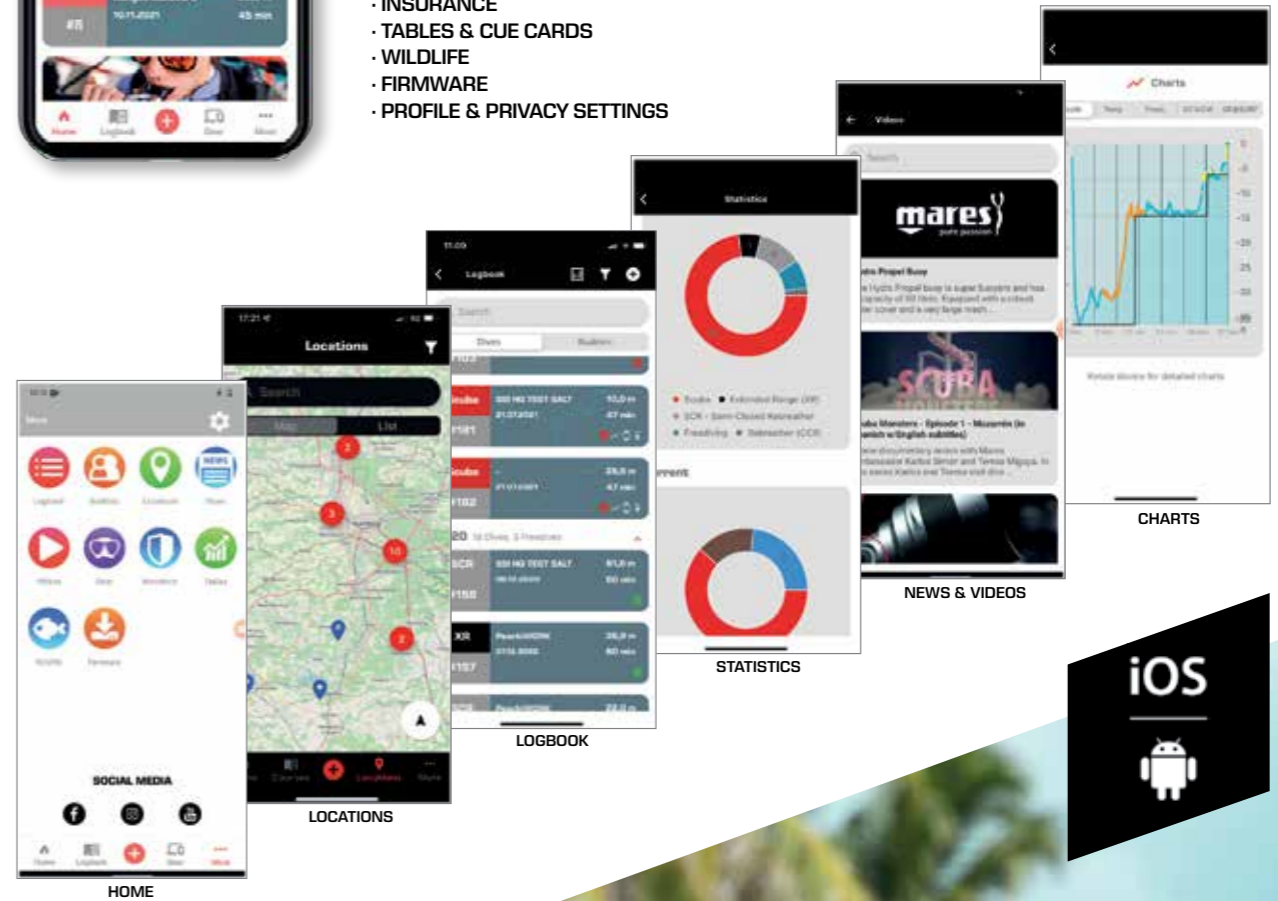

HOME

LOCATIONS

LOGBOOK

STATISTICS

NEWS & VIDEOS

CHARTS

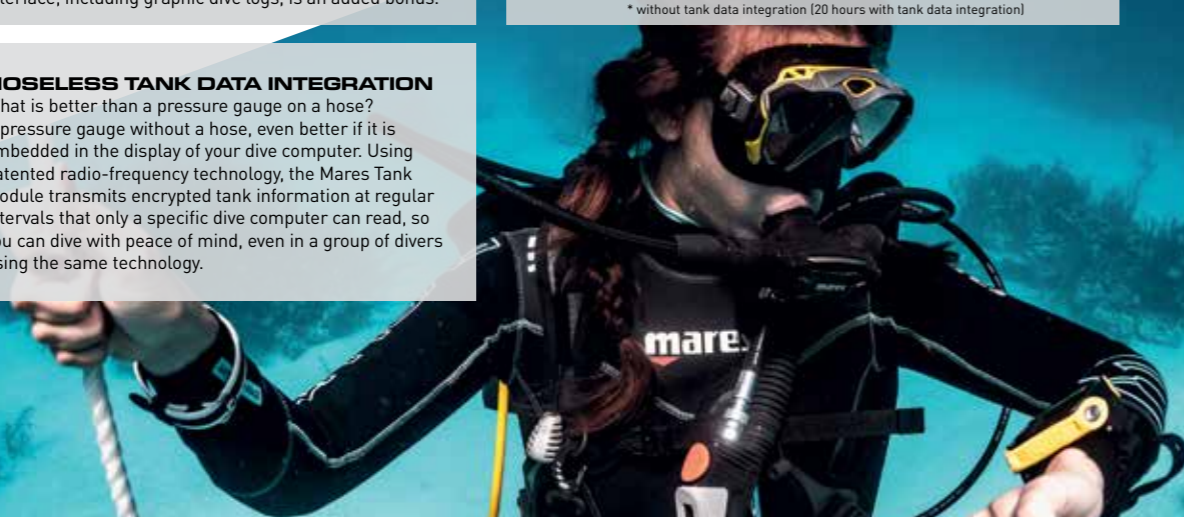

SIRIUS

NEW

Code: 414145



- ZH-L16C ALGORITHM WITH GRADIENT FACTORS AND PREDICTIVE MULTIGAS
- NITROX AND TRIMIX CAPABLE, UP TO 5 GASES
- MIP COLOR HIGH-RESOLUTION DISPLAY
- FULL TILT DIGITAL COMPASS WITH BEARING MEMORY AND STOPWATCH
- HOSELESS TANK DATA INTEGRATION FOR UP TO FIVE TRANSMITTERS
- COLOR CODED TANK PRESSURE FOR AT-A-GLANCE READABILITY
- BOTTOM TIMER MODE WITH RESETTABLE AVERAGE DEPTH AND STOPWATCH
- DECOMPRESSION DIVE PLANNER WITH ADDITIONAL SURFACE INTERVAL FUNCTION
- 100 DIVE LOGBOOK WITH MULTIPLE GRAPHS
- SMART BATTERY MANAGEMENT SYSTEM WITH 30* HOURS DIVE TIME PER FULL CHARGE
- BLUETOOTH CONNECTION FOR DIRECT CONNECTION TO SMARTPHONE
- TISSUE SATURATION AND DIVE PROFILE GRAPH
- UNDERWATER MENU ALLOWS CERTAIN SETTINGS TO BE CHANGED DURING THE DIVE
- FUTURE DECO AND RUNAWAY DECO ALARM
- TWO DIVE DATA DISPLAY OPTIONS
- THREE WATCH FACES PLUS COLOR OPTIONS



TECHNICAL FEATURES

Battery	Type	Rechargeable 200 mAh
	Duration	30* hours dive time / 500 recharge cycles
Nitrox		EAN from 21% to 99%
Trimix		Hypoxic, Normoxic

ACCESSORIES

LED Tank Module 2.0	414322	Page 46
Sirius Strap Kit	414816	Page 47
HP Hose 15 cm / 6"	44201030	Page 46

DETAILS



414322 - LED Tank Module 2.0 (optional)



Longer strap (included)



Wireless charging pad (included)



Rigid shell included

SIRIUS

- MIP DISPLAY TECHNOLOGY
- ZH-L16C ALGORITHM WITH GRADIENT FACTORS
- NITROX AND TRIMIX CAPABLE: UP TO 5 GASES



GAS INTEGRATION READY



DISCOVER MORE



* without tank data integration (20 hours with tank data integration)

GENIUS

Code: 414139



- ZH-L16C ALGORITHM WITH GRADIENT FACTORS AND PREDICTIVE MULTIGAS
- NITROX AND TRIMIX CAPABLE, UP TO 5 GASES
- FULL COLOR HIGH-RESOLUTION DISPLAY
- FULL TILT DIGITAL COMPASS WITH BEARING MEMORY AND STOPWATCH
- HOSELESS TANK DATA INTEGRATION FOR UP TO FIVE TRANSMITTERS
- COLOR CODED TANK PRESSURE FOR AT-A-GLANCE READABILITY
- BOTTOM TIMER MODE WITH RESETTABLE AVERAGE DEPTH AND STOPWATCH
- DECOMPRESSION DIVE PLANNER WITH ADDITIONAL SURFACE INTERVAL FUNCTION
- BRILLIANT LOGBOOK WITH MULTIPLE GRAPHS
- LOGBOOK CAPACITY MORE THAN 1000 HOURS OF DIVE PROFILE AT 5-SECOND SAMPLING RATE
- SMART BATTERY MANAGEMENT SYSTEM WITH 40 HOURS DIVETIME PER FULL CHARGE
- BLUETOOTH CONNECTION FOR DIRECT CONNECTION TO SMARTPHONE
- NIGHT MODE FUNCTION
- MAP VIEWING FUNCTION DURING THE DIVE
- TISSUE SATURATION GRAPH WITH DETAILED INFORMATION
- UNDERWATER MENU ALLows CERTAIN SETTINGS TO BE CHANGED DURING THE DIVE
- FUTURE DECO AND RUNAWAY DECO ALARM (PROPRIETARY)



TECHNICAL FEATURES

Battery	Type	18650 Lithium Ion polymers
	Duration	40 hours dive time / 500 recharge cycles
Nitrox	EAN from 21% to 99%	
Trimix	Hypoxic, Normoxic	

ACCESSORIES

LED Tank Module	414139	Page 46
HP Hose 15 cm / 6"	44201030	Page 46

DETAILS



414139 - LED Tank Module (optional)

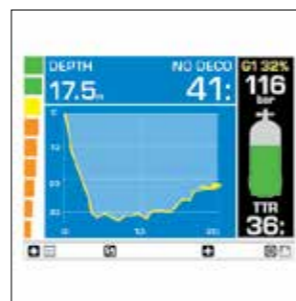

Profile view

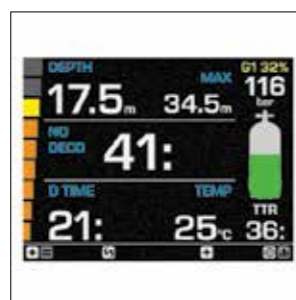

Night mode



44201030 - HP Hose 15 cm / 6" (optional)

GENIUS



POST DIVE

GF TABLE

COMPASS MAIN

COMPASS STOPWATCH AND SET BEARING

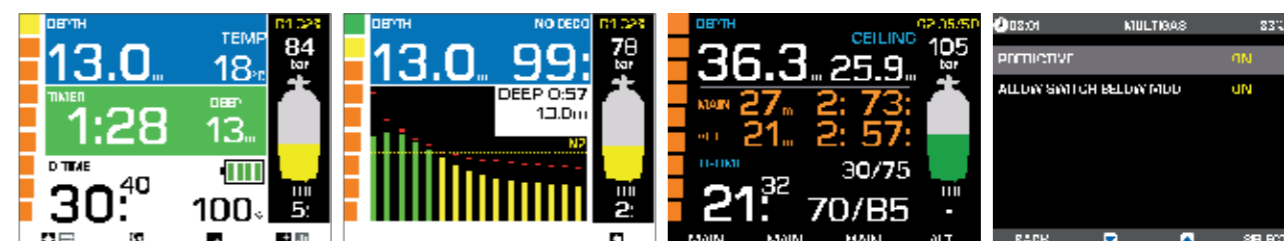

DEEP STOP

DEEP STOP GRAPH WITH TIMER

MAIN GF AND ALTERNATE GF

MULTIGAS SPECIAL FEATURES

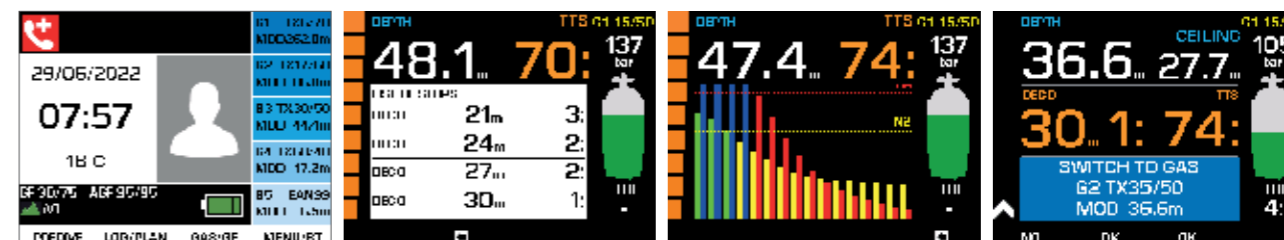

TRIMIX DIVE GASES AND GF

TRIMIX DIVE LIST OF STOPS

TRIMIX DIVE TISSUE SATURATION

TRIMIX GAS SWITCH

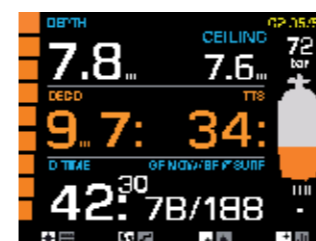

CEIL CON DIVE



CEILING VIOLATION

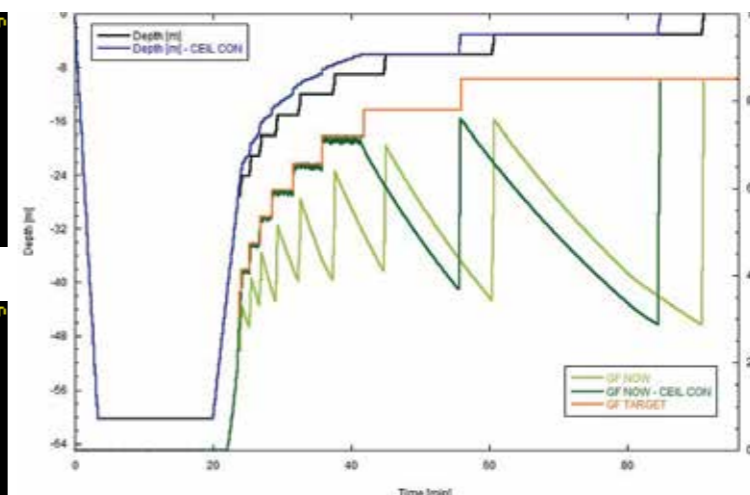

QUAD AIR

Code: 414169



- MAGNIFICENTLY CLEAR DISPLAY WITH JUMBO SIZE INFORMATION
- HOSELESS TANK DATA INTEGRATION FOR UP TO THREE TRANSMITTERS
- THREE-ROW LAYOUT COMPRISES ALL RELEVANT DATA INCLUDING TANK PRESSURE
- TWO CUSTOMIZABLE FIELDS FOR ANCILLARY INFORMATION
- FOUR BUTTONS FOR INTUITIVE USER INTERFACE
- MIRRORRED BUTTON FUNCTION DURING DIVE
- RUNAWAY DECO ALARM
- MULTIGAS CAPABLE
- DECOMPRESSION DIVE PLANNER WITH USER ADJUSTABLE SURFACE INTERVAL
- LONG BATTERY LIFE, USER REPLACEABLE
- DOES NOT INCLUDE INTERFACE AND SOFTWARE FOR DOWNLOADING TO PC

QUAD

Code: 414134



- MAGNIFICENTLY CLEAR DISPLAY WITH JUMBO SIZE INFORMATION
- TWO CUSTOMIZABLE FIELDS FOR ANCILLARY INFORMATION
- FOUR BUTTONS FOR INTUITIVE USER INTERFACE
- MIRRORRED BUTTON FUNCTION DURING DIVE
- OPTION TO VIEW DIVE TIME INCLUDING SECONDS
- RUNAWAY DECO ALARM
- MULTIGAS CAPABLE
- DECOMPRESSION DIVE PLANNER WITH USER ADJUSTABLE SURFACE INTERVAL
- LONG BATTERY LIFE, USER REPLACEABLE
- DOES NOT INCLUDE INTERFACE AND SOFTWARE FOR DOWNLOADING TO PC

SMART AIR

Code: 414138



- HOSELESS TANK DATA INTEGRATION FOR UP TO THREE TRANSMITTERS
- GRAPHIC AND NUMERIC DISPLAY OF TANK PRESSURE
- THREE-ROW LAYOUT COMPRISES ALL RELEVANT DATA INCLUDING TANK PRESSURE
- MULTIGAS CAPABLE
- OPTION TO VIEW DIVE TIME INCLUDING SECONDS
- TWO CUSTOMIZABLE FIELDS FOR ANCILLARY INFORMATION
- LOGBOOK CAPACITY OF 95 HOURS OF DIVE PROFILE
- DECOMPRESSION DIVE PLANNER WITH ADDITIONAL SURFACE INTERVAL FUNCTION
- COMPLETE WATCH FUNCTIONS
- FREEDIVING MODE (APNEA) WITH DEDICATED ALARMS
- BOTTOM TIMER MODE WITH RESETTABLE AVERAGE DEPTH AND STOPWATCH
- USER-REPLACEABLE BATTERY
- DOES NOT INCLUDE INTERFACE AND SOFTWARE FOR DOWNLOADING TO PC

SMART

Code: 414129



- FULL FEATURED NITROX DIVE COMPUTER WITH TWO GAS CAPABILITY
- BOTTOM TIMER MODE WITH RESETTABLE AVERAGE DEPTH AND STOPWATCH
- LOGBOOK CAPACITY IN EXCESS OF 40 HOURS OF DIVE PROFILE AT 5-SECOND SAMPLING RATE (SCUBA) AND MEMORY FUNCTION FOR FREEDIVING
- DECOMPRESSION DIVE PLANNER WITH ADDITIONAL SURFACE INTERVAL FUNCTION
- UPGRADEABLE FIRMWARE
- COMPLETE WATCH FUNCTIONS: STOPWATCH, WAKE-UP ALARM, SECOND TIME ZONE, DATE
- USER-REPLACEABLE BATTERY
- FREEDIVING MODE (APNEA) WITH DEDICATED ALARMS
- DOES NOT INCLUDE INTERFACE AND SOFTWARE FOR DOWNLOADING TO PC



414319 - LED Tank Module (optional)

COLOR VARIATIONS



BKWH BKBK BKYL BKBL



414319 - LED Tank Module (optional)

COLOR VARIATIONS



BKBK BKGR BKRD BKWH WHLL WHLM

TECHNICAL FEATURES

Battery	Type	CR2450
	Duration	150 dives
Nitrox	EAN from 21% to 99%	

ACCESSORIES

LED Tank Module	414319	Page 46
Bluelink Pro	414317	Page 46
Dive Link 2 USB	414316	Page 46
Quad Display Protector	415182	Page 47
HP Hose 15 cm / 6"	44201030	Page 46

TECHNICAL FEATURES

Battery	Type	CR2450
	Duration	200-300 dives
Nitrox	EAN from 21% to 99%	

ACCESSORIES

Quad Display Protector	415182	Page 47
Bluelink Pro	414317	Page 46
Dive Link 2 USB	414316	Page 46

TECHNICAL FEATURES

Battery	Type	CR2430
	Duration	200-300 dives over a three year time span
Nitrox	EAN from 21% to 99%	

ACCESSORIES

LED Tank Module	414319	Page 46
Bluelink Pro	414317	Page 46
Dive Link 2 USB	414316	Page 46
Smart Display Protector	415173	Page 47
Smart Strap Extension	44201190	Page 47
HP Hose 15 cm / 6"	44201030	Page 46

TECHNICAL FEATURES

Battery	Type	CR2430
	Duration	200-300 dives over a three year time span
Nitrox	EAN from 21% to 99%	

ACCESSORIES

Bluelink Pro	414317	Page 46
Dive Link 2 USB	414316	Page 46
Smart Display Protector	415173	Page 47
Smart Strap Extension	44201190	Page 47

PUCK PRO +

Code: **414135**

- SLIM DESIGN FOR A PERFECT FIT
- INTUITIVE USER INTERFACE WITH ONE-BUTTON SIMPLICITY
- LOGBOOK CAPACITY 35 HOURS OF DIVE PROFILE AT 5-SECOND SAMPLING RATE
- UPGRADEABLE FIRMWARE
- BOTTOM TIMER MODE WITH RESETTABLE AVERAGE DEPTH AND STOPWATCH
- USER-REPLACEABLE BATTERY
- DOES NOT INCLUDE INTERFACE AND SOFTWARE FOR DOWNLOADING TO PC



COLOR VARIATIONS

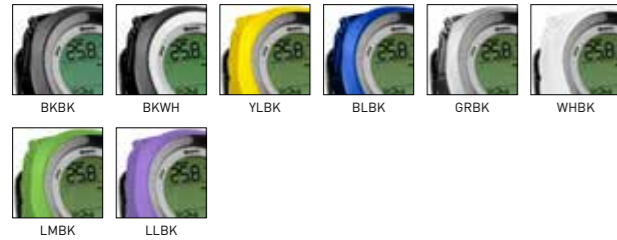

TECHNICAL FEATURES

Battery	Type	CR2450
	Duration	200-300 dives
Nitrox	EAN from 21% to 99%	

ACCESSORIES

Dive Link 2 USB	414316	Page 46
Bluelink Pro	414317	Page 46

PUCK CONSOLES

Code: **414420 Mission Puck 2**

Code: **414421 Mission Puck 3**

- COMPACT CONSOLE WITH FULL FEATURED COMPUTER AND ANALOG PRESSURE GAUGE
- INTUITIVE USER INTERFACE WITH ONE-BUTTON SIMPLICITY
- LOGBOOK CAPACITY 35 HOURS OF DIVE PROFILE AT 5-SECOND SAMPLING RATE
- USER-REPLACEABLE BATTERY
- MULTIPLE LANYARD ATTACHMENT POINTS



MISSION PUCK 2

MISSION PUCK 3

TECHNICAL FEATURES

Battery	Type	CR2450
	Duration	200-300 dives
Nitrox	EAN from 21% to 50%	

ACCESSORIES

Drak USB	414308	Page 46
----------	--------	---------

MISSION 1C WRIST COMPASS

Code: **414404**

- OIL BATH
- SIDE VIEW WINDOW
- WRIST MOUNT CONSOLE



HANDY COMPASS

Code: **414504 Northern Hemisphere**

- OIL BATH
- SIDE VIEW WINDOW
- SPECIAL HOUSING FOR CLIPPING TO BCD



MISSION 1

Code: **414417**

- BRASS CASE
- TECHNOLYMER WINDOW
- PHOSPHORESCENT DIAL FACE
- PROTECTIVE RUBBER CONSOLE
- MULTIPLE ATTACHMENT POINTS



MISSION 2

Code: **414418**

- PRESSURE GAUGE:
- BRASS CASE
 - TECHNOLYMER WINDOW
 - PHOSPHORESCENT DIAL FACE

DEPTH GAUGE:

- OIL BATH
- PHOSPHORESCENT DIAL FACE
- MAX DEPTH INDICATOR
- LINEAR SCALE

CONSOLE:

- PROTECTIVE RUBBER COVER WITH MULTIPLE ATTACHMENT POINTS



MISSION 2C

Code: **414423**

- PRESSURE GAUGE:
- BRASS CASE
 - TECHNOLYMER WINDOW
 - PHOSPHORESCENT DIAL FACE

COMPASS:

- OIL BATH
- SIDE VIEW WINDOW

CONSOLE:

- PROTECTIVE RUBBER COVER WITH MULTIPLE ATTACHMENT POINTS



MISSION 3

Code: **414419**

- PRESSURE GAUGE:
- BRASS CASE
 - TECHNOLYMER WINDOW
 - PHOSPHORESCENT DIAL FACE

DEPTH GAUGE:

- OIL BATH
- PHOSPHORESCENT DIAL FACE
- MAX DEPTH INDICATOR
- LINEAR SCALE

COMPASS:

- OIL BATH
- SIDE VIEW WINDOW

CONSOLE:

- PROTECTIVE RUBBER COVER WITH MULTIPLE ATTACHMENT POINTS



LED TANK MODULE 2.0 **NEW**

Code: **414322**

- TRANSMITS TANK INFORMATION
- COLOR LED FOR QUICK TANK CHECK ON THE SURFACE
- PERMANENT PAIRING
- EN250:2014 CERTIFIED TO 300BAR
- BATTERY TYPE: 14250, USER REPLACEABLE
- BATTERY LIFE: 150+ DIVES
- PAIRS WITH SIRIUS 414145



LED TANK MODULE

Code: **414319**

- TRANSMITS TANK INFORMATION
- COLOR LED FOR QUICK TANK CHECK ON THE SURFACE
- COLOR LED ALERTS BUDDY OF LOW AIR SITUATION DURING DIVE
- PERMANENT PAIRING
- EN250:2014 CERTIFIED TO 300BAR
- BATTERY TYPE: CR123A, USER REPLACEABLE
- PAIRS WITH THE FOLLOWING MODELS: GENIUS (414139), QUAD AIR (414169), SMART AIR (414138)



DIVE LINK 2 USB

Code: **414316**

- FOR DOWNLOADING THE DIVE COMPUTER MEMORY TO PC OR MAC (QUAD, QUAD AIR, PUCK PRO +, SMART, SMART APNEA, SMART AIR)
- REQUIRED SOFTWARE: DIVE ORGANIZER (PC)



BLUELINK PRO

Code: **414317**

- TO DOWNLOAD THE LOGBOOK OF A DIVE COMPUTER USING THE BLUETOOTH LOW ENERGY TECHNOLOGY (QUAD, QUAD AIR, PUCK PRO +, SMART, SMART APNEA, SMART AIR)
- REQUIRES THE MARES AAP OR MYSSI APP (ANDROID, IOS)



DRAK USB

Code: **414308**

- FOR DOWNLOADING THE DIVE COMPUTER MEMORY TO PC OR MAC (ALL PUCK CONSOLES)
- REQUIRED SOFTWARE: DIVE ORGANIZER (PC) OR DIVERS DIARY (MAC)



HP HOSE 15 CM / 6"

Code: **44201030**

- ALLOWS TO MOVE THE LED TANK MODULE AWAY FROM THE FIRST STAGE
- IDEAL FOR IMPROVING SIGNAL RECEPTION IN COMPLEX CONFIGURATIONS
- HELPS AVOID BREAKAGE DUE TO KNOCKING INTO THE MODULE OR TANK TIPPING OVER
- 15 CM / 6" LENGTH



SIRIUS STRAP KIT **NEW**

Code: **414816**

- A COLOR CUSTOMIZATION KIT FOR THE SIRIUS DIVE COMPUTER
- MADE IN HIGHLY COMFORTABLE SILICONE
- AVAILABLE IN BLUE, RED, AQUA AND BLACK
- INCLUDES A LONGER STRAP FOR THICK WET OR DRY SUITS



SMART STRAP EXTENSION

Code: **44201190**

- FOR USE WITH THICK WET OR DRY SUITS
- FOR SMART ONLY



QUAD DISPLAY PROTECTOR

Code: **415182**

- EASY TO INSTALL
- PREVENTS FROM SCRATCHES
- SOFT AND DURABLE
- ULTRA CLEAR



SMART DISPLAY PROTECTOR

Code: **415173**

- PERFECT FIT AND EASE OF INSTALLATION
- AVOIDS SCRATCHES, DIRT AND SAND
- SOFT AND DURABLE
- ULTRA TRANSPARENT
- SOLD IN A PACK OF 2



DIVE ORGANIZER

- FULL-FEATURED LOGBOOK MANAGEMENT SOFTWARE
- ALLOWS UPGRADING OF FIRMWARE ON COMPATIBLE DIVE COMPUTERS
- ALLOWS UPLOADING OF MAPS AND IMAGES TO GENIUS
- FEATURES TISSUE SATURATION GRAPH WITH DETAILED EVOLUTION DURING THE DIVE
- FOR PC ONLY

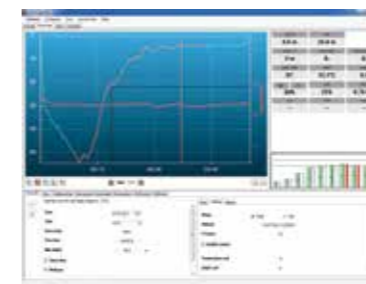

TENDER

- CAN BE USED TO REPROGRAM THE GENIUS COMPUTER ON A MAC OS X PLATFORM
- DIVES CAN BE DOWNLOADED WITH SUBSEQUENT UPDATES



MISSION 1000

NEW

Code: 414815

- SOLID MARINE-GRADE STAINLESS STEEL CASE WITH SCREW-ON BACK AND SCREW DOWN CROWN
- DIMENSIONS: 44MM DIAMETER X 15MM HEIGHT X 48.5MM LUG TO LUG
- CASE INCLUDES ENGRAVED SERIAL NUMBER
- AUTOMATIC WATCH (SEIKO NH 35 / ACCURACY: -6.3 SEC/DAY)
- ROTATING BEZEL
- DIAL WITH LUMINESCENT HANDS AND HOUR MARKERS
- SAPPHIRE CRYSTAL
- CALENDAR
- HELIUM ESCAPE VALVE
- WATERPROOF DOWN TO 1000M/100 BAR
- HIGH-QUALITY, DURABLE RUBBER STRAP WITH PRINTED DECORATION (INCLUDES A 22MM LUG)



COLOR VARIATIONS



BK

BL

COMPUTERS



Computers	Sirius	Genius	Quad Air	Quad	Smart Air	Smart	Puck Pro +	Mission Puck 2	Mission Puck 3
Code	414145	414139	414169	414134	414138	414129	414135	414420	414421
Colors	BK BK	BKSI	BK BK	BK BK, BK BL, BK WH, BK YL	BK BK	BK BK, BK GR, BK RD, BK WH, WH LM	BK BK, BK WH, BL BK, GR BK, LL BK, LB BK, WH BK, YL BK		
ZH-L16C GF	■	■							
RGBM			■	■	■	■	■		■
Trimix	■	■							
TFT Color Display		■							
MIP Color Display	■								
Segment Display			■	■	■	■	■		■
Air Integrated	■	■	■		■	■			
Graphic and numeric tank pressure	■	■							
Gas Switching	■	■	■	■	■	■	■		
Software Upgradeability	■	■	■	■	■	■			
USB Charger		■							
Inductive Charging	■								
One Button Control							■		■
Mineral Glass	■	■	■	■	■	■	■		
Max Display Depth	150m / 492ft	150m / 492ft	150m / 492ft	150m / 492ft	150m / 492ft	150m / 492ft	150m / 492ft		150m / 492ft
Rechargeable Batteries	■	■							
Dive hours per charge	30hr*	40hr							
User Replaceable Batteries			■	■	■	■	■		■
Residual Nitrogen Reset	■	■	■	■	■	■	■		■
Option to Exclude Audible Alarms	■	■	■	■	■	■	■		■
Ascent Rate Indicator	■	■	■	■	■	■	■		■
Memory Capacity	> 100hr	1000hr	> 100hr	35hr	95hr	40hr	36h		36hr
Profile Sampling Rates	5s	5s	5s	5s	5s	5s	5s		5s
Dual Time	■	■			■	■	■		
Stopwatch	■	■	■**	■**	■	■	■		
Daily Alarm	■	■			■	■			

* 30 hr (20 hr with tank data integration)
** Bottom Timer mode



BCD'S



GUARDIAN ERGOTRIM

NEW

Code: 417105



- THE ERGOTRIM TECHNOLOGY ALLOWS THE DIVER TO ADJUST BUOYANCY NO MATTER THE DIVING POSITION
- THE ERGO COMMAND CAN BE USED LIKE A 'CLASSIC' INFLATOR BY AN INSTRUCTOR WHEN TEACHING, BUT WILL WORK AS AN AIR TRIM WHEN IN ITS DEDICATED HOLDER
- THE AIRCELL IS SEPARATED FROM THE SHOULDERS, MEANING GREATER COMFORT IN THE SHOULDER AREA WHEN INFLATED
- HIGH LIFT AIRCELL WITH WINGLETS
- MONOPLATE BACKPACK FITS SINGLE OR DOUBLE TANKS
- 50MM SWIVEL BUCKLES
- STAINLESS STEEL D-RINGS
- ADJUSTABLE CUMMERBUND
- TWO LARGE CARGO POCKETS WITH SUPRATLEX STRETCH PANELS AND AN ADDITIONAL UPPER POCKET TO STORE SMALLER ITEMS
- SMART TRIM WEIGHT POSITIONING
- SLS WEIGHT SYSTEM
- VISUAL CONFIRMATION OF PROPER WEIGHT POUCH INSERTION
- PERSONALIZABLE LABEL ON WEIGHT POCKETS
- COLOR CUSTOMIZATION POSSIBLE WITH A DEDICATED ADDITIONAL KIT AVAILABLE TO PURCHASE IN 4 DIFFERENT COLORS (CODE 417966)
- AN INTEGRATED SLOT ALLOWS THE DIVER TO ADD A LINE CUTTER WITH THE OPTIONAL COLOR KIT AVAILABLE TO PURCHASE SEPARATELY



TECHNICAL FEATURES

Guardian Ergotrim	XS	S	M	L	XL
Weight	4.8kg / 10.6lb	4.8kg / 10.6lb	5kg / 11lb	5.1kg / 11.2lb	5.35kg / 11.8lb
Buoyancy	130N [14.1kg / 31lb]	150N [15.5kg / 34lb]	180N [18.8kg / 41lb]	200N [20.4kg / 45lb]	230N [23.9kg / 53lb]

ACCESSORIES

Color Kit	417966	Page 54
Magnetic Connector	415804	Page 59
BCD Attachment Kit	415178	Page 60

DETAILS



ErgoTrim configuration and quick release connection



Standard Ergo configuration



Optional color kit in 4 colors (Code 417966)



Color customization includes a Titanium line cutter

ERGOTRIM

TECHNOLOGY

GUARDIAN & GRACE

In 2001, Mares took the dive industry by storm when it introduced AIRTRIM technology. One of the most innovative BC features ever designed, it combined inflation and deflation in one single, ergonomically well-placed control. While inflation took place as usual, feeding intermediate pressure gas from the first stage into the Aircell, deflation was carried out by pneumatically activating two exhaust valves. These were placed at both ends of the BCD, one on the right shoulder and one on the bottom left of the aircell, and they were activated simultaneously, so that no matter the diver's position in the water, gas was sure to be released. With one valve high enough to vent gas, the other would be low enough to take in water, so to prevent water entry into the aircell, both valves had a one-way flapper valve in front of them. Oral inflation, if needed in case of an emergency, could be performed via a medical-style tube housed in a side pocket. We called it AIRTRIM because it made achieving the perfect trim so much easier.

That was in 2001. In 2022, Mares outdid itself by introducing version 2.0 of this technology. We named it ERGOTRIM, because we combined pneumatic deflation with the "standard" ERGO inflator. Well, not so standard. The BCD inflates and deflates as with a normal inflator, but it has an additional button to feed the pneumatic circuit. A rocker switch has been placed on top of the inflate and pneumatic deflate buttons to prevent the user from operating both at the same time. If you are an instructor and need to show standard maneuvers to your students, you can carry the ERGOTRIM on your left shoulder. For everybody else, ERGOTRIM equipped jackets have a sleeve in the back of the aircell which routes the corrugated hose under the left shoulder and positions it in a holder. Ergonomically, it is similar to the original, but it has a 40% higher flow-rate for inflation, is more integrated into the BC and, in case of emergency, oral inflation can be performed by removing it from the holder, bringing it to your mouth and exhaling into it. The end result is a very streamlined BC, one-hand operation under all circumstances, a free left shoulder and the peace of mind that comes with knowing that you don't need to change your position in the water to deflate your BC.

STANDARD ERGO CONFIGURATION



ERGOTRIM CONFIGURATION



SCAN THE
QR CODE
TO SEE THE
VIDEO

GRACE ERGOTRIM

NEW

Code: 417106



- THE ERGOTRIM TECHNOLOGY ALLOWS THE DIVER TO ADJUST BUOYANCY NO MATTER THE DIVING POSITION
- THE ERGO COMMAND CAN BE USED LIKE A 'CLASSIC' INFLATOR BY AN INSTRUCTOR WHEN TEACHING, BUT WILL WORK AS AN AIR TRIM WHEN IN ITS DEDICATED HOLDER
- THE AIRCELL IS SEPARATED FROM THE SHOULDERS, MEANING GREATER COMFORT IN THE SHOULDER AREA WHEN INFLATED
- HIGH LIFT AIRCELL WITH WINGLETS
- MONOPLATE BACKPACK FITS SINGLE OR DOUBLE TANKS
- 50MM SWIVEL BUCKLES
- STAINLESS STEEL D-RINGS
- ADJUSTABLE CUMMERBUND
- TWO LARGE CARGO POCKETS WITH SUPRATLEX STRETCH PANELS AND AN ADDITIONAL UPPER POCKET TO STORE SMALLER ITEMS
- SMART TRIM WEIGHT POSITIONING
- SLS WEIGHT SYSTEM
- VISUAL CONFIRMATION OF PROPER WEIGHT POUCH INSERTION
- PERSONALIZABLE LABEL ON WEIGHT POCKETS
- COLOR CUSTOMIZATION POSSIBLE WITH A DEDICATED ADDITIONAL KIT AVAILABLE TO PURCHASE IN 4 DIFFERENT COLORS (CODE 417966)
- AN INTEGRATED SLOT ALLOWS THE DIVER TO ADD A LINE CUTTER WITH THE OPTIONAL COLOR KIT AVAILABLE TO PURCHASE SEPARATELY
- DEDICATED BLADDER, PROVIDING THE PERFECT FIT FOR FEMALE DIVERS



TECHNICAL FEATURES

Grace Ergotrim	XXS	XS	S	M	L
Weight	4.7kg / 10.3lb	4.8kg / 10.6lb	4.8kg / 10.6lb	5kg / 11lb	5.1kg / 11.2lb
Buoyancy	140N [14.7kg / 32lb]	140N [14.7kg / 32lb]	140N [14.7kg / 32lb]	140N [14.7kg / 32lb]	170N [17.8kg / 39lb]

ACCESSORIES

Color Kit	417966	Page 54
Magnetic Connector	415804	Page 59
BCD Attachment Kit	415178	Page 60

DETAILS



ErgoTrim configuration and quick release connection



Standard Ergo configuration



Optional color kit in 4 colors (Code 417966)



Color customization includes a Titanium line cutter

COLOR KIT GUARDIAN & GRACE

Guardian and Grace ErgoTrim models also come with a color kit option, available to purchase separately, which allows the diver to customize their BCD. The color kit not only includes color panels, but also a Titanium line cutter that can be placed on the shoulder. It is user friendly and can be assembled easily by the end consumer.

The graphic illustrates the customization options for the Guardian and Grace BCDs. It features a central image of a BCD with callouts to various components:

- Color Panels:** Two circular callouts show blue and black panels with the Mares logo.
- Line Cutters:** A circular callout shows a black Titanium line cutter.
- Weight Pouches:** A circular callout shows two blue weight pouches with the Mares logo.
- Weight Pouches (Alternative Colors):** A circular callout shows five weight pouches in different colors: blue, teal, red, and black.

 At the bottom, a horizontal row displays the complete color kit components for four different color schemes: blue/black, teal/black, red/black, and black/black. Each kit includes two color panels, a Titanium line cutter, and five weight pouches in the specified colors.

COLOR KIT

Code: 417966



- COLOR CUSTOMIZATION FOR THE GUARDIAN AND GRACE ERGOTRIM
- USER-FRIENDLY COLOR PANELS ALLOW FOR BCD CUSTOMIZATION
- MARES TITANIUM LINE CUTTER ALSO INCLUDED



DRAGON SLS / KAILA SLS

Code: 417223 Dragon SLS

Code: 417363 Kaila SLS

- SUPERBLY COMFORTABLE AND STABLE YET TOUGH AND DURABLE
- AIRCELL SLIDES ON SHOULDERS FOR INCREASED COMFORT WHEN INFLATED
- POSITION OF THE CORRUGATED HOSE RETAINING EPAULETTE CAN BE ADJUSTED
- HIGH LIFT AIRCELL WITH "DRAGON" WINGLETS
- SMART TRIM WEIGHT POSITIONING
- SLS WEIGHT SYSTEM
- SWIVEL BUCKLES: 50MM ON THE DRAGON, 40MM ON THE KAILA
- HIGH CAPACITY CARGO POCKETS WITH STRETCH PANELS
- ADJUSTABLE CUMMERBUND
- MONOPLATE BACKPACK FITS SINGLE OR DOUBLE TANKS
- VISUAL CONFIRMATION OF PROPER WEIGHT POUCH INSERTION
- PERSONALIZABLE LABEL ON WEIGHT POCKETS



TECHNICAL FEATURES

Dragon SLS	XS	S	M	L	XL
Weight	4.2kg / 9.25lb	4.2kg / 9.25lb	4.4kg / 9.7lb	4.5kg / 9.9lb	4.75kg / 10.5lb
Buoyancy	130N (14.1kg / 31lb)	150N (15.5kg / 34lb)	190N (18.8kg / 41lb)	200N (20.4kg / 45lb)	230N (23.9kg / 53lb)

Kaila SLS	XXS	XS	S	M	L
Weight	4.1kg / 9lb	4.2kg / 9.25lb	4.2kg / 9.25lb	4.4kg / 9.7lb	4.5kg / 9.9lb
Buoyancy	110N (10.8kg / 24lb)	130N (14.1kg / 31lb)	150N (15.5kg / 34lb)	180N (18.8kg / 41lb)	200N (20.4kg / 45lb)

ACCESSORIES

BCD Attachment Kit	415178	Page 60
Magnetic Connector	415804	Page 59

DETAILS



"Dragon" aircell

High capacity cargo pockets with stretch panels



Adjustable epaulette

50mm swivel buckles

MAGELLAN

Code: 417226



- THE TRUE TRAVEL BCD: EXTREMELY LIGHTWEIGHT
- INTEGRATED QUICK RELEASE WEIGHT SYSTEM
- OPTIONAL TRIM WEIGHT (TO BE PLACED ON THE TANK BAND)
- FOLDABLE WITH NO RIGID BACKPACK
- STRAP LOOP BACKPACK FEATURE FOR EASY ADJUSTMENT
- 1 ROLL-UP POCKET
- CONCAVE ERGONOMIC SHOULDERS (PATENT PENDING): INCREASED COMFORT IN CHEST/SHOULDER AREA
- TROUBLE FREE FOR FEMALE DIVERS



TECHNICAL FEATURES

Magellan	XXS/XS	S/M	L/XL
Weight	2.0kg / 4.4lb	2.1kg / 4.6lb	2.3kg / 5lb
Buoyancy	180N (18.5kg / 41lb)	180N (18.5kg / 41lb)	180N (18.5kg / 41lb)

ACCESSORIES

Trim Weight	417964	Page 60
Magnetic Connector	415804	Page 59
BCD Attachment Kit	415178	Page 60

DETAILS



Quick release buckle system



Optional trim weights



Ergonomic concave shoulders



Roll up pocket

BOLT SLS

Code: 417362

- AN EXTREMELY COMFORTABLE, STABLE, BACK BUOYANCY BC WITH 21KG LIFT (46 LBS)
- STREAMLINED
- SWIVEL SHOULDER BUCKLES
- SMART TRIM WEIGHT POSITIONING
- SLS WEIGHT SYSTEM
- ROLL-DOWN CARGO POCKET
- ADJUSTABLE CUMMERBUND
- VISUAL CONFIRMATION OF PROPER WEIGHT POUCH INSERTION
- PERSONALIZABLE LABEL ON WEIGHT POCKETS



TECHNICAL FEATURES

Bolt SLS	XS	S	M	L	XL
Weight	3.6kg / 7.9lb	3.7kg / 8.1lb	3.7kg / 8.1lb	3.9kg / 8.6lb	3.9kg / 8.6lb
Buoyancy	180N (18.5kg / 41lb)	180N (18.5kg / 41lb)	180N (18.5kg / 41lb)	180N (18.5kg / 41lb)	180N (18.5kg / 41lb)

ACCESSORIES

BCD Attachment Kit	415178	Page 60
Magnetic Connector	415804	Page 59

PRESTIGE SLS

Code: 417224 BL

Code: 417225 WH

- EXCELLENT LIFT CAPACITY
- LIGHT, STRONG DURABLE 420 DENIER CORDURA
- IMPROVED FIT: SWIVELING BUCKLES ON THE SHOULDERS AND A SMALLER AIRCELL
- SLS INTEGRATED WEIGHT SYSTEM
- 3-DIMENSIONAL ZIPPERED, SELF-DRAINING POCKETS
- 2 REAR TRIM WEIGHT POCKETS



TECHNICAL FEATURES

Prestige SLS BL	XS	S	M	L	XL
Weight	3.4kg / 7.5lb	3.5kg / 7.7lb	3.85kg / 8.5lb	3.9kg / 8.6lb	4kg / 8.8lb
Buoyancy	120N (12.2kg / 27lb)	130N (13.8kg / 30lb)	150N (16kg / 35lb)	180N (18.3kg / 38lb)	200N (21kg / 46lb)

Prestige SLS WH	XXS	XS	S	M	L
Weight	3.3kg / 7.3lb	3.4kg / 7.5lb	3.5kg / 7.7lb	3.85kg / 8.5lb	3.9kg / 8.6lb
Buoyancy	100N (10.8kg / 24lb)	120N (12.2kg / 27lb)	130N (13.8kg / 30lb)	150N (16kg / 35lb)	180N (18.3kg / 38lb)

ACCESSORIES

BCD Attachment Kit	415178	Page 60
Magnetic Connector	415804	Page 59

ROCK PRO

Code: 417107



- RESISTANT TO THE MOST EXTREME CONDITIONS
- INTEGRATED STANDARD WEIGHT SYSTEM
- GREAT WEARABILITY THANKS TO ENVELOPING SHOULDER STRAPS
- ANATOMICAL POCKETS, CUT TO MINIMISE WATER RESISTANCE DURING MOVEMENT
- POCKETS INCLUDE AN INTERNAL ELASTIC STRAP FOR ACCESSORY CLIPS
- PADDED BACKPLATE
- STRATEGICALLY POSITIONED STEEL D-RINGS
- REDUCED WEIGHT: TRAVEL FRIENDLY



TECHNICAL FEATURES

Rock Pro	XS	S	M	L	XL
Weight	3kg / 6.7lb	3.1kg / 6.8lb	3.3kg / 7.2lb	3.4kg / 7.5lb	3.45kg / 7.6lb
Buoyancy	140N (14.7kg / 32lb)	150N (15.7kg / 34lb)	160N (16.6kg / 36lb)	200N (20.6kg / 45lb)	230N (23.7kg / 52lb)

ACCESSORIES

Trim Weight	417964	Page 60
Magnetic Connector	415804	Page 59

ROCK

Code: 417263



- RESISTANT TO THE MOST EXTREME CONDITIONS
- GREAT WEARABILITY THANKS TO ENVELOPING SHOULDER STRAPS
- ANATOMICAL POCKETS, CUT TO MINIMISE WATER RESISTANCE DURING MOVEMENT
- POCKETS INCLUDE AN INTERNAL ELASTIC STRAP FOR ACCESSORY CLIPS
- PADDED BACKPLATE
- STRATEGICALLY POSITIONED STEEL D-RINGS
- REDUCED WEIGHT: TRAVEL FRIENDLY



TECHNICAL FEATURES

Rock	XS	S	M	L	XL
Weight	2.6kg / 5.7lb	2.7kg / 5.9lb	2.8kg / 6.2lb	2.85kg / 6.3lb	2.85kg / 6.3lb
Buoyancy	140N (14.2kg / 31.3lb)	150N (16kg / 35lb)	160N (16.3kg / 35.9lb)	200N (21kg / 46lb)	235N (24kg / 52.9lb)

ACCESSORIES

Trim Weight	417964	Page 60
Magnetic Connector	415804	Page 59

EXPLORER

Code: 417229

- KID/JUNIOR BCD WITH A DEDICATED BACKPACK
- 2 COMFORTABLE POCKETS WITH VELCRO® BRAND CLOSURE
- SPECIALLY DESIGNED OCTOPUS AND PRESSURE GAUGE POCKETS
- OPTIONAL TRIM WEIGHTS TO BE PLACED ON TANK STRAP
- TANK BAND: DEDICATED ADAPTABLE SHORTER TANK BAND TO FIT SMALLER TANKS
- 1 SIZE FITS ALL, FROM 8 - 12 YEARS, THANKS TO A DEDICATED ADJUSTMENT SYSTEM



TECHNICAL FEATURES

Explorer	3XS
Weight	1.8kg / 3.9lb
Buoyancy	70N (7.8kg / 17lb)

ACCESSORIES

Trim Weight	417964	Page 60
Weight Pocket Explorer	417965	Page 59
Magnetic Connector	415804	Page 59

WEIGHT POCKET EXPLORER

Code: 417965 (PAIR)

- EXPANDS THE CAPABILITY OF THE EXPLORER BC
- RELEASEABLE WEIGHT POCKETS FIT INTO CARGO POCKETS FOR EASY ACCESS
- CAPACITY 1 KG / 2LBS



MAGNETIC CONNECTOR

Code: 415804

- SIMPLE AND SECURE
- FAST AND EASY MAGNETIC CONNECTION
- SINGLE-HANDED USE
- 360° FREE-SWIVELLING
- SAFE UNLOCKING, EVEN WITH A FULL LOAD
- DESIGNED TO ATTACH TO ALL BCD D-RINGS
- HIGH-QUALITY, STURDY MATERIALS
- SAFELY SECURES A VARIETY OF EQUIPMENT
- HOLDING STRENGTH 60KG / 132 LBS



DISCOVER MORE



BK

YL

DETAILS



Independent magnetic connection



Simple, quick and safe to unlock



360° rotating, free-tilting ball head

SLS SLIDE & LOCK SYSTEMCode: **417959** - SMALL: 4kg / 9lb (PAIR)*Code: **417960** - LARGE: 6kg / 13lb (PAIR)*

- STURDY ZIPPERED POCKET FOR QUANTUM BCD'S
- EASY TO SLIDE INTO POCKET
- VISUAL AID TO SEE IF SYSTEM IS PROPERLY ENGAGED
- SAFEST SYSTEM AVAILABLE
- EASY TO USE WITH THICK GLOVES

**STANDARD WEIGHT SYSTEM**Code: **417968** - SMALL: 4kg / 9lb (PAIR)Code: **417967** - LARGE: 6kg / 13lb (PAIR)

- ADD-ON TO UPGRADE BCD WITH STANDARD BUCKLE WEIGHT SYSTEM
- VELCRO® BRAND CLOSURE ON POCKET
- EASY USE WITH THICK GLOVES

**TRIM WEIGHT**Code: **417964** (PAIR)

- EASY TO INSTALL ON TANK BAND
- DOUBLE LOOP TO FIT PERFECTLY ON THE BAND
- PERFECT BUOYANCY
- LESS WEIGHT ON THE BELT
- WEIGHT CAPACITY: 2KG EACH

**HOSE RETAINER**Code: **415157**

- HEAVY DUTY HOOKS
- SWIVEL SOLUTION
- TWO POSITIONS TO HANG HOSES

**BCD ATTACHMENT KIT**Code: **415178**

- IDEAL SOLUTION FOR YOUR EXTENSION POLE
- EASY TO INSTALL
- FITS ONTO MARES BCD'S



* Patented

LANYARD STAINLESS SPIRAL WITH RINGCode: **415732**

- STAINLESS STEEL SPIRAL CABLE
- PROVIDES EXTENSION MORE THAN 50 CM/20 IN
- QUICK RELEASE BUCKLE
- TO AVOID LOOSE ACCESSORIES

**LANYARD SPIRAL WITH RING**Code: **415717**

- SPIRAL CABLE PROVIDES MORE THAN 50 CM/20 IN EXTENSION
- STAINLESS STEEL RING
- QUICK RELEASE BUCKLE

**LANYARD OPEN LOOP**Code: **415722**

- MULTI FUNCTIONAL LANYARD WITH OPEN LOOP
- THE LOOP ALLOWS WIDE ATTACHMENT FUNCTIONALITY
- MALE/FEMALE QUICK RELEASE BUCKLE

**LANYARD MALE/FEMALE**Code: **415716**

- MULTI FUNCTIONAL
- PLUG IN AND USE WITH MOST STANDARD BUCKLE SYSTEMS
- FAST LEASH OPENING FOR SIMPLE ATTACHMENT

**STANDARD RETRACTOR**Code: **415715**

- STAINLESS STEEL CABLE
- HEAVY DUTY HOOKS ON BOTH SIDES
- MORE THAN 60 CM/23,5 IN WHEN EXTENDED

**CONSOLE HOLDER WITH VELCRO® BRAND FASTENER**Code: **415718**

- STRONG VELCRO® BRAND FASTENER TO HOLD AND RELEASE WHEN NEEDED
- QUICK RELEASE SYSTEM USED FOR CONSOLE AND OCTOPUS
- QUICK ADJUSTING ROPE LEASH FOR FLEXIBLE FASTENING



BCD'S



BCD	Guardian Ergotrim	Grace Ergotrim	Dragon SLS	Kaila SLS	Magellan	Bolt SLS	Prestige SLS	Rock Pro	Rock	Explorer	
Code	417105	417106	417223	417363	417226	417362	417224	417225	417107	417263	417229
Sizes	XS - S - M - L - XL	XXS - XS - S - M - L	XS - S - M - L - XL	XXS - XS - S - M - L	XXS/XS - S/M - L/XL	XS - S - M - L - XL	XS - S - M - L - XL	XXS - XS - S - M - L	XS - S - M - L - XL	XS - S - M - L - XL	3XS
Fusion Bladder	■		■								
Classic Bladder							■	■	■	■	
Backmounted					■	■					
Ergo Inflator	■		■		■	■	■	■	■	■	
Ergotrim	■										
Monoplate Backpack	■		■			■	■	■	■	■	
Foldable Backpack					■						
Materials	Cordura® 420		Cordura® 420	Cordura® 420	Cordura® 420	Cordura® 420	Cordura® 420	Cordura® 420	Cordura® 420	Cordura® 420	Cordura® 420
D-rings	Stainless steel	5	5			6	2	6	6		
	Aluminium				4						
	Heavy-duty Technopolymer				1		4				2
Weight	Size L	5.1kg / 11.2lb	4.5kg / 9.9lb	2.3kg / 5lb	3.9kg / 8.6lb	3.9kg / 8.6lb	3.9kg / 8.6lb	3.4kg / 7.5lb	2.85kg / 6.3lb		
	3XS										70N (7.8kg / 17lb)
Buoyancy	XXS			110N (10.8kg / 24lb)	180N (18.5kg / 41lb)		100N (10.8kg / 24lb)				
	XS	130N (14.1kg / 31lb)	140N (14.7kg / 32lb)	130N (14.1kg / 31lb)	130N (14.1kg / 31lb)	180N (18.5kg / 41lb)	180N (18.5kg / 41lb)	120N (12.2kg / 27lb)	120N (12.2kg / 27lb)	140N (14.7kg / 32lb)	140N (14.2kg / 31.3lb)
	S	150N (15.5kg / 34lb)	140N (14.7kg / 32lb)	150N (15.5kg / 34lb)	150N (15.5kg / 34lb)	180N (18.5kg / 41lb)	180N (18.5kg / 41lb)	130N (13.8kg / 30lb)	130N (13.8kg / 30lb)	150N (15.7kg / 34lb)	150N (16kg / 35lb)
	M	180N (18.8kg / 41lb)	140N (14.7kg / 32lb)	180N (18.8kg / 41lb)	180N (18.8kg / 41lb)	180N (18.5kg / 41lb)	180N (18.5kg / 41lb)	150N (16kg / 35lb)	150N (16kg / 35lb)	160N (16.6kg / 36lb)	160N (16.3kg / 35.9lb)
	L	200N (20.4kg / 45lb)	170N (17.8kg / 39lb)	200N (20.4kg / 45lb)	200N (20.4kg / 45lb)	180N (18.5kg / 41lb)	180N (18.5kg / 41lb)	180N (18.3kg / 38lb)	180N (18.3kg / 38lb)	200N (20.6kg / 45lb)	200N (21kg / 46lb)
	XL	230N (23.9kg / 53lb)		230N (23.9kg / 53lb)		180N (18.5kg / 41lb)	180N (18.5kg / 41lb)	200N (21kg / 46lb)		230N (23.7k / 52lb)	235N (24kg / 52.9lb)

WEIGHT POCKETS										
BCD	Guardian Ergotrim	Grace Ergotrim	Dragon SLS	Kaila SLS	Magellan	Bolt SLS	Prestige SLS	Rock Pro	Rock	Explorer
SLS 417959 (small - max 4 kg) 417960 (large - max 6 kg)	XS - S M - L - XL	XXS - XS - S M - L	XS - S M - L - XL	XXS - XS - S M - L	-	XS - S - M L - XL	XS - S M - L - XL	XXS - XS - S M - L	-	-
Standard Weight System 417963 (small - max 4 kg) 417962 (large - max 6 kg)					XXS/XS - S/M L/XL			XXS/XS - S/M L/XL		
Weight Pocket Explorer 417965										Optional



SUITS



FLEXA GRAPHENE

Code: 412078 Man

Code: 412079 She Dives



- MAXIMUM THERMAL COMFORT IN THE MOST CRITICAL AREAS THANKS TO THE SOFT, WARM FABRIC LINING WITH GRAPHENE INSERTS THAT HELPS RETAIN HEAT
- WATERPROOF, HORIZONTAL, MASTERSEAL REAR ZIP
- ZIPPERS ON ANKLES
- SUPRATLEX KNEE PADS
- HOOD WITH GLIDESKIN LINING AND VENTING SYSTEM
- S-SEAL TECHNOLOGY TO ENSURE BETTER THERMAL COMFORT
- POP-OUT POCKET DESIGN
- GRIP AREA ON THE WRISTS FOR FASTENING INSTRUMENTS
- EASY DRESSING AND DRESSING THANKS TO THE ULTRASTRETCH NEOPRENE



TECHNICAL FEATURES

Thickness	7mm										
Fabric Type	Ultrastretch Neoprene										
Man sizes*	2	3	3L	3W	4	4L	4W	5	5W	6	7
She Dives sizes*	1	2	3	3L	3W	4	4L	4W	5		

DETAILS



Versatile pop-out pocket

Thermal Graphene lining

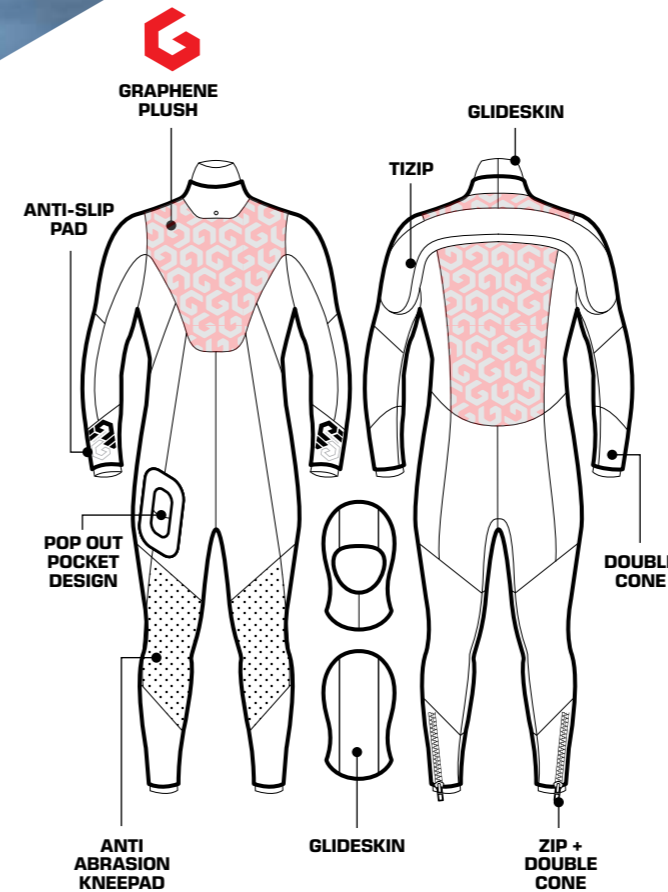

FLEXA GRAPHENE

What is GRAPHENE material?

It is a thick, strong material which is an excellent heat conductor. From tests, we have found that Graphene has the capacity to raise temperatures by 5°C when in contact with heat, in this case from the body.

The Flexa Graphene is the most advanced Mares semidry suit, with an innovative Graphene coating that helps to increase body temperature by retaining body heat. S-seal technology ensures additional thermal comfort.

The suit features a soft, flexible, waterproof Masterseal zip on the back, and further zips at the ankles.

Ultrastretch neoprene means easy donning and doffing. A comfortable, new 'pop out' pocket has been placed on the right thigh, and a hood is included with Glideskin material for a better seal.

The Flexa Graphene is not just a semidry suit, it is a revolutionary concept. It helps the diver stay warmer for longer, providing a perfect fit, with a unique Mares design!



* L and W sizes are only available in selected countries

ICE SKIN

Code: 412102 Man
Code: 412103 She Dives



- WATERPROOF T-ZIP ZIPPER
- MADE IN ELASTIC NEOPRENE FOR MAXIMUM COMFORT
- PREFORMED CUT FOR OPTIMAL FIT
- INTEGRATED ZIPPERED POCKET
- SPECIAL INTERNAL FABRIC TO INCREASE THERMAL COMFORT WHERE MOST NEEDED
- NECK, WRIST AND ANKLE SEALS IN GLIDE SKIN FOR MAXIMUM SEAL
- PREFORMED HOOD INCLUDED
- REINFORCED KNEEPADS
- GRIP AREA ON THE WRISTS FOR FASTENING INSTRUMENTS



TECHNICAL FEATURES

Thickness	7mm					
Fabric Type	Ultrastretch Neoprene					
Man sizes	2	3	4	5	6	7
She Dives sizes	1	2	3	4	5	

DETAILS



Anti-slip wrist detail for dive computers



Waterproof T-Zip zipper

PRO THERM

NEW

Code: 412437 Man
Code: 412438 She Dives



- 8/7 MM 'SEMIDRY STYLE' SUIT WITH A FRONT ZIP
- EASY DONNING AND DOFFING THANKS TO ULTRASTRETCH NEOPRENE
- HORIZONTAL YKK TEK-FLEX ZIPPER
- INNER LAYER INCLUDES A NECK DAM TO IMPROVE THERMAL COMFORT AND MAKE THE SUIT MORE WATERTIGHT
- INTEGRATED HOOD WITH GLIDESKIN LINING AND VENTING SYSTEM
- 'FIRE PLUSH' ON THE TORSO AND BACK FOR THERMAL COMFORT AND SOFTNESS ON THE SKIN
- SUPRATLEX KNEEPADS
- SHOULDER GRIP AREA FOR BETTER COMFORT WHEN WEARING A BCD
- GRIP AREA ON WRISTS TO KEEP A COMPUTER/INSTRUMENT IN PLACE WHEN DIVING
- GLIDESKIN LINING ON THE WRISTS AND ANKLES INCREASES COMFORT AND WATER TIGHTNESS
- ZIPPERED POCKET ON THE RIGHT LEG WITH AN ELASTIC LOOP FOR ATTACHING SMALL ACCESSORIES



TECHNICAL FEATURES

Thickness	8/7mm															
Fabric Type	Ultrastretch Neoprene															
Man sizes*	2	3	3L	3W	4	4L	4W	5	5L	5W	6	6L	6W	7	7W	8
She Dives sizes*	1	2	2L	2W	3	3L	3W	4	4L	4W	5	6				

DETAILS



Glideskin lining



Water Dam System

* L and W sizes are only available in selected countries

PRO THERM



The Pro Therm wetsuit enters Mares' neoprene line with unique features such as a horizontal, water resistant, YKK Tek Flex front zipper that allows the diver to don and doff their suit autonomously.

A neck dam, an integrated hood with a venting system and a Glideskin lining at the wrists and ankles minimize water entry while being gentle on the skin, optimizing thermal comfort without compromising ease of use while diving and when donning and doffing.

The suit also provides maximum warmth thanks to its 8mm thickness with strategic 7mm sections where elasticity and freedom of movement are needed the most. In addition to this, the use of a Fire Plush material lining on the torso and back improves thermal comfort and is soft on the skin.

A shoulder grip area offers better support when wearing a BCD and an anti-slip grip design on wrists keeps your computer/instrument in place while diving.

The suit's kneepads are made in Supratex, the perfect choice that combines an abrasion-resistant material with the necessary elasticity. The unique Mares design is especially tailored to men and women, with a dedicated cut for each model.

That's not all...the Mares Pro Therm also features a zippered pocket on the right leg with an elastic loop to attach small accessories.

This suit is a masterpiece that is able to combine thermal comfort, durability, freedom of movement and functionality in an exclusive design!



TECHNICAL FEATURES	
NEOPRENE TYPE	Ultrastretch neoprene
THICKNESS	8/7mm
SPECIAL FABRICS	Fire Plush lining on the torso/back and a water dam on the upper body
THERMAL COMFORT	Includes a water dam on the upper body to minimize water entry
ZIPPER	YKK Tek Flex water-resistant front zip
WRISTS	Glideskin lining and anti-slip area for computers
ANKLES	Glideskin lining
HOOD	Integrated hood with venting system and Glideskin lining
POCKET	Zippered pocket with an elastic loop inside

NEOPRENE TYPES

GLIDE SKIN

An outer coating applied over a closed-cell neoprene rubber sheets. It enhances gliding and prevents water absorption if used on the outer side, while it helps position stability and seal closure if used internally.

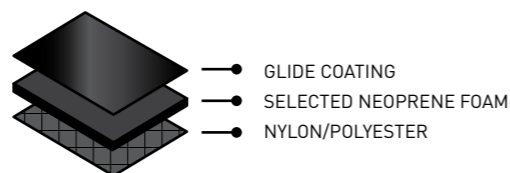

GLIDING

DOUBLE FACE (DF) Standard Neoprene

An outer/inner lamination with nylon and polyester series fabric applied over a closed-cell neoprene rubber. It provides the suits with a smooth feel, colorful and durable. All fabrics are chemical resistant, elastic and low moisture contents (4,5%), suitable for all water sports products.

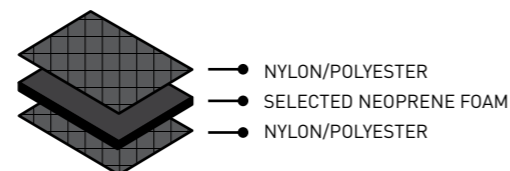

ENDURANCE COLORFUL

DOUBLE FACE FLEX (DFF) Ultrastretch

An outer/inner lamination with super stretch nylon and polyester series fabric applied over a closed-cell neoprene rubber. It provides the suits with a soft smooth feel, high elastic, colorful, durable and regains products desired shape. All fabrics help to increase free movement, leading to high performance on products.

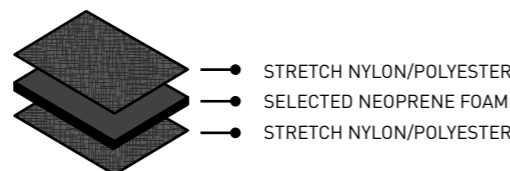

ENDURANCE ELASTIC RETURN IN SHAPE HI-COMFORT



NEW

FLEXA

8/6MM

Code: 412431 Man

Code: 412432 She Dives

5/4MM

Code: 412433 Man

Code: 412434 She Dives

3/2MM

Code: 412435 Man

Code: 412436 She Dives



- THE ULTIMATE EXPRESSION OF MARES DESIGN COMBINED WITH 100% ULTRASTRETCH MATERIAL
- VARIED MATERIAL THICKNESS PLACED STRATEGICALLY ON DIFFERENT AREAS OF THE BODY
- 3 DIFFERENT COLORS FOR THE 3 DIFFERENT THICKNESSES, WITH A MEN'S AND WOMEN'S DEDICATED CUT AND DESIGN
- NEW SOFT CLOSURE ON THE NECK FOR BETTER COMFORT
- GLIDESKIN LINING ON THE WRISTS AND ANKLES FOR INCREASED COMFORT AND WATER TIGHTNESS
- GRIP AREA ON WRISTS TO KEEP A COMPUTER/INSTRUMENT IN PLACE WHEN DIVING
- NEW BACK COMFORT SYSTEM AND GRIP IN THE SHOULDER AREA TO INCREASE COMFORT WHEN WEARING A BCD
- EMBOSSED SUPRATLEX KNEEPADS WITH A NEW DEDICATED DESIGN
- INTEGRATED BUCKLE ON THE LEG FOR HOOD OR SMART POCKET ATTACHMENT [SOLD SEPARATELY, CODE 412341]



8/6 mm

5/4 mm

3/2 mm

TECHNICAL FEATURES

Thickness	8/6mm - 5/4mm																	
Fabric Type	Ultrastretch Neoprene																	
Man sizes*	2			3	3L	3W	4	4L	4W	5	5L	5W	6	6L	6W	7	7W	8
She Dives sizes*	1	2	2L	2W	3	3L	3W	4	4L	4W	5	5W	6					

Thickness	3/2mm						
Fabric Type	Ultrastretch Neoprene						
Man sizes	2	3	4	5	6	7	
She Dives sizes	1	2	3	4	5		

DETAILS



Color changes according to suit thickness



412341 - Smart Pocket [Sold separately]

* L and W sizes are only available in selected countries

FLLEXA

ULTRASTRETCH



The ultimate expression of Mares design combined with 100% Ultrastretch material.

The Flexa suit family offers a wide range of high-quality wetsuits to choose from based on your diving conditions. The Mares Flexa is not just a single wetsuit, but a family of three. The Flexa 8/6 is designed to protect divers in cold water environments. The Flexa 5/4 is appropriate for temperate waters. The Flexa 3/2 is best for warm water diving.

Mares Flexa wetsuits use different neoprene thickness for different areas of the body, in 100% Ultrastretch, top-quality neoprene with an unparalleled finish and attention to detail. Available in a wide variety of sizes, the Flexa wetsuit is appropriate for both male and female divers, with a dedicated design and tailored cut for each model and an extended size range for the best wearability.

The suits are equipped with a front zipper that includes a smooth neoprene flap and a new, soft custom closure for better

comfort at the neck.

These suits can easily be combined with the Mares Flexa Core Shorty or the Flexa Vest if an additional layer is needed. A Back Comfort System (BCS) covers the back and shoulders. This construction increases comfort on the most stressed areas when wearing a BCD, together with a dedicated shoulder grip area. An anti-slip print on the wrists keeps your computer/instrument in place when diving. Wrist and ankle panels also have a Glideskin lining to minimize water entry at the sleeves and legs. Kneepads are included in embossed Supratex, the perfect anti-abrasive material that does not compromise elasticity, with a unique Mares design.

Last but not least, the Flexa wetsuit series comes with an integrated clip to hold your diving hood in place or attach the optional Flexa Smart Pocket, making it more versatile.

Mares Flexa suits are the most sophisticated expression of Mares design. Nothing has been left to chance!



TECHNICAL FEATURES

NEOPRENE TYPE	Ultrastretch neoprene
THICKNESS	8/6 - 5/4 - 3/2mm
ZIPPER	Front zipper with soft flap closure
BACK	BCS Comfort System on the back and over the shoulders
WRISTS	Glideskin lining and anti-slip area for computers/instruments
ANKLES	Glideskin lining
POCKET	Flexa Smart Pocket (sold separately) can be attached to the integrated clip and VELCRO® brand fasteners
HOOD	6.5 mm hood with venting system (sold separately)

EVOLUTION 5MM

Code: **412176 Man**
Code: **412177 She Dives**



- A VERY COMFORTABLE 5MM SUIT WITH A BACK ZIP IN A NEW, EXCLUSIVE MARES DESIGN
- SUPER STRETCHY NEOPRENE FOR EASY DRESSING AND DOFFING AND GREATER EASE OF USE WHILE DIVING
- GLIDESKIN ON THE INNER WRISTS AND ANKLES FOR A PERFECT SEAL
- ANTI-SCRATCH CUSTOM CLOSURE
- REINFORCED KNEEPADS WITH A DEDICATED PRINT
- SHOULDER GRIP AREA FOR BETTER COMFORT WHILE WEARING THE BCD
- ANTI-SLIP GRIP AREA ON WRISTS TO HELP SECURE YOUR DIVING INSTRUMENTS
- THE SHE DIVES VERSION FEATURES A DEDICATED FEMALE CUT
- 5MM HOOD SOLD SEPARATELY (CODE 412826)



TECHNICAL FEATURES

Thickness	5mm											
Fabric Type	Ultrastretch Neoprene											
Man sizes*	2	3	3W	4	4L	4W	5	5L	5W	6	7	8
She Dives sizes*	1	2	3	3L	3W	4	4L	4W	5		6	

DETAILS



Reinforced kneepads



Exclusive Mares design: functionality and style

* L and W sizes are only available in selected countries

EVOLUTION 7MM

NEW

Code: **412439 Man**
Code: **412440**



- A VERY COMFORTABLE 7MM SUIT WITH A BACK ZIP IN A NEW, EXCLUSIVE MARES DESIGN
- SUPER STRETCHY NEOPRENE FOR EASY DRESSING AND DOFFING AND GREATER EASE OF USE WHEN DIVING
- ANTI-SCRATCH CLOSURE
- REINFORCED KNEEPADS WITH A DEDICATED PRINT
- SHOULDER GRIP AREA FOR A BETTER COMFORT WHEN WEARING A BCD
- GRIP AREA ON WRISTS TO KEEP A COMPUTER/INSTRUMENT IN PLACE WHEN DIVING
- GLIDESKIN LINING ON THE WRISTS AND ANKLES INCREASES COMFORT AND WATER TIGHTNESS
- ZIPPERS ON ANKLES WITH A GLIDESKIN DOUBLE CONE CONSTRUCTION
- THE SHE DIVES VERSION FEATURES A DEDICATED FEMALE CUT
- 7MM HOOD SOLD SEPARATELY (CODE 412828)



TECHNICAL FEATURES

Thickness	7mm													
Fabric Type	Ultrastretch Neoprene													
Man sizes*	2		3		3W	4	4L	4W	5	5L	5W	6	7	8
She Dives sizes*	1	2	2L	2W	3	3L	3W	4	4L	4W	5	5W	6	

DETAILS



Zippers on ankles



Optional Hood

* L and W sizes are only available in selected countries

EVOLUTION

5 7



The new Mares Evolution family of wetsuits is for divers who particularly appreciate easy donning and comfort. In addition to this, the high elasticity of the whole suit improves its watertight qualities and reduces water circulation. The Evolution is available in 5mm and 7mm to satisfy a diver's different needs in terms of thermal comfort, with a male and female tailored cut, a dedicated design and an extended size range to achieve the best wearability. The suit is equipped with a back zipper and a smooth neoprene flap with a soft custom closure for better neck comfort. Wrists and ankles include a Glideskin lining to minimize water

entry at the sleeves and legs. The 7mm version features zippers on the ankles with a double cone construction that makes the suit watertight and facilitates donning and doffing. Reinforced kneepads include a dedicated print, a shoulder grip area provides better comfort when wearing a BCD, and an anti-slip grip area on wrists keeps your computer/instrument in place while diving. 5mm and 7mm hoods with a venting system and Glideskin lining are available to purchase separately. Mares Evolution suits are the expression of sophistication, simplicity and functionality!

TECHNICAL FEATURES	
NEOPRENE TYPE	Super-stretchy neoprene
THICKNESS	5mm and 7mm
ZIPPER	Back zipper with soft flap closure
WRISTS	Glideskin lining and anti-slip area for computers/instruments
ANKLES	5mm version features Glideskin lining 7mm version includes zippers on ankles with Glideskin double cone construction
SHOULDERS	Grip area for a better comfort when wearing a BC
HOOD	5mm and 7mm hoods available to purchase separately

PIONEER

- 7MM**
- Code: **412346 Man**
- Code: **412347 She Dives**

- 5MM**
- Code: **412344 Man**
- Code: **412345 She Dives**

- COMFORTABLE ANTI-SCRATCH CUSTOM CLOSURE
- ZIPPERS ON THE ANKLES (ONLY ON THE 7 MM VERSION) MAKE DONNING AND DOFFING EFFORTLESS
- HOOD INCLUDED
- THE HOOD VENTING SYSTEM ASSISTS THE RELEASE OF AIR, OPTIMIZING EQUALIZATION AND COMFORT
- NECK WITH ANTI-ABRASION VELCRO® BRAND CLOSURE PREVENTS WETSUIT DAMAGE
- INSTRUMENT GRIPS ON BOTH WRISTS
- HOOD KEEPER D-RING ON THE RIGHT LEG
- KNEEPAD IN ANTI-ABRASIVE MATERIAL



7 mm

5 mm

TECHNICAL FEATURES

Thickness	7mm / 5mm							
Fabric Type	Neoprene & Ultrastretch Neoprene							
Man sizes	2	3	4	5	6	7	8	
She Dives sizes	1	2	3	4	5			

DETAILS



Hood Included

Zippers on the ankles (only on the 7 mm version)

DUAL

- Code: **412375 Man**
- Code: **412376 She Dives**

- TRADITIONAL COMBINATION OF A LONG JOHN AND A JACKET
- THICKEST NEOPRENE AREA CONCENTRATED ON CHEST AND BACK AREAS WHERE THERMAL PROTECTION IS MOST NEEDED
- GLIDESKIN WRIST AND ANKLE SEALS
- LEAVES ARMS AND LEGS WITH A FEELING OF FREEDOM AND MOBILITY
- STRATEGICALLY PLACED ELASTIC INSERTS
- INSTRUMENT GRIP AREA ON BOTH WRISTS
- KNEEPAD IN ANTI-ABRASIVE MATERIAL



TECHNICAL FEATURES

Thickness	5mm						
Fabric Type	Neoprene						
Man sizes	2	3	4	5	6	7	
She Dives sizes	1	2	3	4	5		

REEF

- Code: **412382 Man**
- Code: **412383 She Dives**

- MODERN DESIGN WITH SHOULDER GRIP AREA
- COOL, STRETCHY AND IDEAL FOR TEMPERATE WATER
- ERGONOMIC, COMFORTABLE VELCRO® BRAND CLOSURE AND BACK ZIP PULLER
- WRIST, ANKLE AND NECK SEALS ENRICHED WITH AQUASTOP FINISH



TECHNICAL FEATURES

Thickness	3mm							
Fabric Type	Neoprene							
Man sizes	2	3	4	5	6	7	8	
She Dives sizes	1	2	3	4	5	6		

SWITCH

Code: 412428 Man

Code: 412429 She Dives



- 2 SUITS IN 1: A NEW REVERSIBLE SUIT CONCEPT
- CAN BE WORN ON BOTH SIDES: CHOOSE BETWEEN A SIMPLE, CLASSIC BLACK DESIGN OR A MORE SPORTY, COLORFUL DESIGN
- AN EXTRA-COMFORTABLE, 2.5MM SUIT WITH A FRONT ZIP IN ULTRASTRETCH NEOPRENE
- NEW EXCLUSIVE MARES DESIGN
- PERFECT FOR WARM WATER DIVING AND ALL WATERSPORTS
- DEDICATED FEMALE CUT
- ANTI-SLIP GRIP AREA ON WRISTS TO HELP SECURE YOUR DIVING INSTRUMENTS



TECHNICAL FEATURES

Thickness	2.5mm							
Fabric Type	Ultrastretch Neoprene							
Man sizes	2	3	4	5	6	7	8	
She Dives sizes	1	2	3	4	5	6		

SWITCH

Did you ever wish to have 2 suits in one?
 Diving one day colorful and another day more classic style?
 Do you think that this can happen only in fashion like a with a reversible jacket?
 Mares created a 2.5mm Steamer in Man and She Dives version with a dedicated cut and style.
 The suit is made with a reversible concept so that you can use it both sides according to your wish.
 One side more sporty and stylish and the other side more conservative.
Do not get bored, surprise yourself, surprise everybody!

REVERSIBLE BEAEB2IBRE

SIDE 1

SIDE 2



FLEXA CORE

Code: 412342 Man

Code: 412343 She Dives



- ULTRA-ELASTIC SHORTY WITH ATTACHED HOOD FOR GREATER THERMAL COMFORT
- COMPLETES THE FAMILY OF FLEXA SUITS, BUT CAN ALSO BE USED WITH ANY MARES SUIT
- CAN BE USED AS A STAND-ALONE PRODUCT
- INTEGRATED BUCKLE ON THE LEG FOR HOOD ATTACHMENT OR ATTACHMENT OF A CUSTOMIZED POCKET (SOLD SEPARATELY)



TECHNICAL FEATURES

Thickness	4mm							
Fabric Type	Ultrastretch Neoprene							
Man sizes	2	3	4	5	6	7	8	
She Dives sizes	1	2	3	4	5	6		

2ND SKIN SHORTY

Code: 412371 Man

Code: 412372 She Dives

- MADE WITH METALITE (WITH HEAT REFLECTING AND HEAT RETAINING PROPERTIES)
- BEST WORN UNDERNEATH A STEAMER
- EXTREMITIES IN GLIDE SKIN ON THE LEGS, TOGETHER WITH THE ERGONOMIC NECK CLOSURE AND THE 0,5 MM HOOD, CREATE AN EXTREMELY WATER RESISTANT SHORTY
- CAN ALSO BE USED AS A SNORKELING SUIT



TECHNICAL FEATURES

Thickness	1.5mm							
Fabric Type	Ultrastretch Neoprene / Metalite Inside							
Man sizes	2	3	4	5	6	7		
She Dives sizes	1	2	3	4	5	6		

REEF SHORTY

Code: 412384 Man

Code: 412385 She Dives

- COOL, STYLISH, LIGHTWEIGHT AND EXCELLENT FOR WARM WATER DIVES AND LONG SNORKELING SESSIONS
- HIGH LEVEL OF FINISH ON ALL DETAILS INCLUDING NECK CUSTOM CLOSURE AND BACK ZIP PULLER
- ERGONOMIC COMFORTABLE VELCRO® BRAND CLOSURE AND BACK ZIP PULLER
- AQUASTOP FINISH ON ARMS AND THIGHS



TECHNICAL FEATURES

Thickness	2.5mm							
Fabric Type	Neoprene							
Man sizes	2	3	4	5	6	7	8	
She Dives sizes	1	2	3	4	5	6		

FLEXA VEST

Code: 412537 Man

Code: 412538 She Dives

- INCREASES HEAT RETENTION IN COLD WATER DIVING
- IDEAL FOR WEARING UNDER FLEXA SUITS
- LOW COMPRESSION NEOPRENE ON THE TOP OF THE HEAD



TECHNICAL FEATURES

Thickness	3mm							
Fabric Type	Ultrastretch Neoprene							
Man sizes	2	3	4	5	6	7		
She Dives sizes	1	2	3	4	5			

GOLD SKIN

Code: 412411 Man

Code: 412412 She Dives

- NEOPRENE WITH OUTER COVERING AND OPEN-CELL INTERIOR WITH GOLD SKIN COATING



TECHNICAL FEATURES

Thickness	2mm							
Fabric Type	Neoprene - Gold Skin coated interior							
Man sizes	2	3	4	5	6	7	8	
She Dives sizes	1	2	3	4	5			

SCUBA RANGER

Code: **412373 Jacket**

Code: **412374 Long John**

- DEDICATED KID'S TWIN SUIT: LONG-SLEEVED, HOODED JACKET AND LONG JOHN (SOLD SEPARATELY)
- JACKET AND LONG JOHN CAN BE WORN TOGETHER OR SEPARATELY ACCORDING TO WATER TEMPERATURE
- DEDICATED DESIGN AND COLOR FOR KIDS: SHOULDERS AND ZIPPERS IN LIME
- VARIED THICKNESSES STRATEGICALLY PLACED IN DIFFERENT AREAS OF THE BODY FOR COMFORT AND FREEDOM OF MOVEMENT
- EASY DONNING AND DOFFING



TECHNICAL FEATURES

Thickness	5mm			
Fabric Type	Neoprene			
Sizes	-3	-2	-1	0
Ages*	8Y	10Y	12Y	14Y

*Ages indicated in the table are purely for reference



THERMO GUARD SHORTY

Code: **412536 BL (Man)**

Code: **412536 AQ (She Dives)**

Code: **412536 YL (Junior)**

- ALWAYS HANDY
- EXTREMELY VERSATILE PRODUCT THAT CAN BE USE AS A FIRST LAYER OR AS A STANDALONE IN WARM WATERS
- METALITE FABRIC INSIDE
- THE PERFECT CHOICE FOR SWIMMING POOLS OR SNORKELING
- JUNIOR SIZES WITH DEDICATED GRAPHICS AVAILABLE



UPF 50+

TECHNICAL FEATURES

Thickness	1.5mm								
Fabric Type	Neoprene / Metalite Inside								
Man sizes (BL)									
She dives sizes (AQ)									
Junior sizes (YL)	-3	-2	-1	0					

THERMO GUARD

LONG SLEEVE

Code: **412550 Man**

Code: **412554 She Dives**

SHORT SLEEVE

Code: **412549 Man**

Code: **412553 She Dives**

SHORTS

Code: **412534 Man**

Code: **412535 She Dives**

- CORE BODY COMFORT FOR ALL WATER SPORTS
- EASY TO WEAR
- METALITE COATING HELPS BODY HEAT RETENTION
- FLAT STITCHING FOR COMFORTABLE CONTACT WITH YOUR BODY



UPF 50+

TECHNICAL FEATURES

Thickness	0.5mm						
Fabric Type	Neoprene / Metalite Inside						
Man sizes							
She Dives sizes							
	XXS	XS	S	M	L	XL	XXL
							3XL

RASH GUARD UPF BLOCK 80+

Code: 412413 Man BL
 Code: 412414 She Dives LIL
 Code: 412415 Junior YL

- LONG-SLEEVED RASH GUARD UPF BLOCK 80+ AVAILABLE IN A MAN'S, WOMAN'S AND JUNIOR VERSION WITH DEDICATED CUT
- COOL, LIGHTWEIGHT MATERIAL
- FAST DRYING
- FLAT SEAM CONSTRUCTION FOR COMFORT



UPF 80+

TECHNICAL FEATURES

Thickness	-							
Fabric Type	Nylon / Spandex							
Man sizes		XS	S	M	L	XL	XXL	3XL
She Dives sizes	XXS	XS	S	M	L	XL	XXL	
Sizes Junior			S	M	L	XL		

RASH GUARD

LONG SLEEVE
 Code: 412551 Man
 Code: 412555 She Dives

SHORT SLEEVE
 Code: 412552 Man
 Code: 412556 She Dives

SHORTS
 Code: 412547 Man
 Code: 412548 She Dives

- FOR ALL KINDS OF WATER SPORTS
- COOL, LIGHTWEIGHT MATERIAL
- FAST DRYING
- FLAT SEAM CONSTRUCTION FOR COMFORT



UPF 50+

TECHNICAL FEATURES

Thickness	-							
Fabric Type	Polyester / Spandex							
Man sizes		XS	S	M	L	XL	XXL	3XL
She Dives sizes	XXS	XS	S	M	L	XL	XXL	3XL

RASH GUARD LOOSE FIT

LONG SLEEVE
 Code: 412541 She Dives LIL / She Dives AQ

SHORT SLEEVE
 Code: 412540 Man LM / Man BL
 Code: 412542 She Dives AQ

- BE COOL AND PROTECTED
- LOOSE FIT STYLE
- VIBRANT COLORS
- FAST DRYING
- IDEAL AS AN UNDERGARMENT OR BY ITSELF
- FLAT SEAM CONSTRUCTION FOR COMFORT



UPF 80+

TECHNICAL FEATURES

Thickness	-							
Fabric Type	Nylon / Spandex							
Man sizes		XS	S	M	L	XL	XXL	3XL
She Dives sizes	XXS	XS	S	M	L	XL	XXL	

TRILASTIC STEAMER

Code: 412545 Man
 Code: 412546 She Dives

- SNORKELING WITHOUT WORRIES
- PROTECTS ALMOST YOUR ENTIRE BODY SURFACE FROM SOLAR RAYS OR OCCASIONAL SEA ENCOUNTERS
- CAN BE USED AS THE PERFECT LAYER UNDER A RENTAL SUIT
- STIRRUPS EQUIPPED FOR SECURE PLACEMENT



UPF 50+

TECHNICAL FEATURES

Thickness	-							
Fabric Type	Polyester / Spandex							
Man sizes		XS	S	M	L	XL	XXL	3XL
She Dives sizes	XXS	XS	S	M	L	XL	XXL	

PHOTOSUIT

Code: 412525

- IDEAL FOR DIVE PHOTOGRAPHY
- TO BE WORN OVER A WETSUIT
- 4 COLORS AVAILABLE



UPF 50+

TECHNICAL FEATURES

Thickness	-			
Fabric Type	Polyester / Spandex			
Sizes Unisex	1	2	3	4

RASH GUARD JUNIOR

Code: 412506 Boys

Code: 412507 Girls

- LIGHTWEIGHT AND COOL MATERIAL
- UPF+50 PROTECTION
- QUICK DRYING
- ULTRA COMFORTABLE FLAT SEAMS
- DEDICATED CUT FOR BOYS



RASH GUARD KID

LONG SLEEVE

Code: 412543 Boys

Code: 412544 Girls

SHORT SLEEVE

Code: 412559 Boys

Code: 412560 Girls

- LIGHTWEIGHT AND COOL MATERIAL
- UPF+50 PROTECTION
- QUICK DRYING
- ULTRA COMFORTABLE FLATLOCK SEAMS
- CHILD-FRIENDLY CUT



ULTRA SKIN

WHAT IS ULTRA SKIN ABOUT?

The Mares Ultra Skin Line is a complete range of apparel designed for any sporting adventure: whether you are diving or doing other watersports, the Ultra Skin is the right choice. Designed as a stand-alone piece, it is also suitable under a wetsuit or a dry suit. Ultra Skin technology combines three layers of fabric studied to deliver the best performance, thermal comfort and with neutral buoyancy. When worn as a standalone, the Mares Ultra Skin provides 50+ UPF protection from the sun's harmful rays. Every style comes equipped with thumb loops and stirrups to prevent it riding up when being worn as an undergarment. A full range of sizes and varieties are available, including accessories.

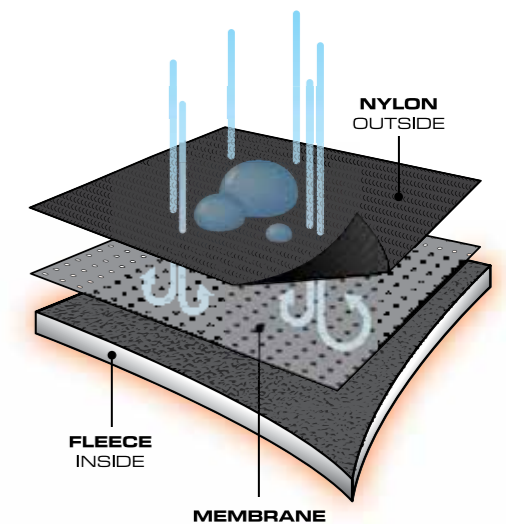

UPF 50+

TECHNICAL FEATURES

Thickness	-				
Fabric Type	Polyester / Spandex				
Sizes	XS	S	M	L	XL
Ages*	8/9	9/10	10/11	11/12	12/13

UPF 50+

TECHNICAL FEATURES

Thickness	-				
Fabric Type	Polyester / Spandex				
Sizes	XS	S	M	L	XL
Ages*	2/3	3/4	4/5	5/6	6/7

* Ages indicated in the table are purely for reference

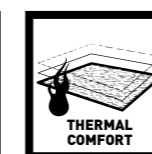

ULTRASKIN

MAN
Code: 412394 Steamer
Code: 412389 Long Sleeve
Code: 412393 Short Sleeve
Code: 412391 Sleeveless with Hood
Code: 412392 Sleeveless without Hood
Code: 412398 Shorts
Code: 412423 Long Pants

SHE DIVES
Code: 412420 Steamer
Code: 412397 Long Sleeve
Code: 412419 Short Sleeve
Code: 412399 Sleeveless with Hood
Code: 412418 Sleeveless without Hood
Code: 412390 Shorts
Code: 412424 Long Pants

- INNOVATIVE UNDERSUIT WITH THERMAL COMFORT PROPERTIES
- ULTRASKIN TECHNOLOGY COMBINES 3 DIFFERENT LAYERS: INSIDE FLEECE FOR GREAT COMFORT, A WINDPROOF, BREATHABLE MEMBRANE AND AN OUTER, STRETCHY LAYER FOR A PERFECT FIT AND GREAT FREEDOM OF MOVEMENT
- SUITABLE UNDER A WETSUIT, AS A DRY SUIT UNDERSUIT OR PERFECT ALONE FOR ALL WATERSPORTS
- A FULL RANGE OF STYLES AND ACCESSORIES TO MEET EVERYONE'S NEEDS, IN MALE AND FEMALE VERSIONS



UPF 50+

TECHNICAL FEATURES

Thickness	-						
Fabric Type	Outer: Nylon/Elastan - Mid: PU Membrane - Inner: Polyester/Elastan						
Man sizes	S	M	L	XL	XXL	3XL	
She Dives sizes	XS	S	M	L	XL	XXL	

ULTRASKIN

- A FULL RANGE OF STYLES AND ACCESSORIES TO MEET EVERYONE'S NEEDS
- ULTRASKIN TECHNOLOGY COMBINES 3 DIFFERENT LAYERS: INSIDE FLEECE FOR GREATER COMFORT, A WINDPROOF BREATHABLE MEMBRANE AND AN OUTER STRETCHY LAYER FOR A PERFECT FIT AND GREAT FREEDOM OF MOVEMENT
- SUITABLE AS UNDERGARMENTS OR PERFECT ALONE FOR ALL WATERSPORTS

GLOVES

Code: 412728



TECHNICAL FEATURES

Thickness	-					
Sizes	XS	S	M	L	XL	XXL

SOCKS

Code: 412642



TECHNICAL FEATURES

Thickness	-						
Sizes	XS	S	M	L	XL	XXL	3XL

LONG HOOD

Code: 412825



TECHNICAL FEATURES

Thickness	-						
Sizes	XS	S	M	L	XL	XXL	3XL



FLEXA FIT 6.5MM

Code: 412725

- ULTRASTRETCH NEOPRENE
- INNOVATIVE CUT
- PRE-SHAPED CUT AND GLIDE SKIN CUFFS WITH WATERSTOPS
- GOOD FREEDOM OF MOVEMENT



TECHNICAL FEATURES

Thickness	6,5 mm			
Sizes	S	M	L	XL

FLEXA FIT 5MM

Code: 412724

- ULTRASTRETCH NEOPRENE
- INNOVATIVE CUT
- PRE-SHAPED CUT AND GLIDE SKIN CUFFS WITH WATERSTOPS
- GOOD FREEDOM OF MOVEMENT



TECHNICAL FEATURES

Thickness	5 mm							
Sizes	XXS	XS	S	M	L	XL	XXL	3XL

FLEXA CLASSIC 5MM

NEW

Code: 412734

- LINED NEOPRENE ON BOTH SIDES
- RUBBER PATTERN ON PALMS FOR A BETTER GRIP



TECHNICAL FEATURES

Thickness	5mm						
Sizes	XXS	XS	S	M	L	XL	XXL

FLEXA CLASSIC 3MM

Code: 412723

- LINED NEOPRENE ON BOTH SIDES
- RUBBER PATTERN ON PALM FOR GREATER GRIP



TECHNICAL FEATURES

Thickness	3mm						
Sizes	XXS	XS	S	M	L	XL	XXL

FLEXA TOUCH 2MM

Code: 412726

- MAXIMUM FREEDOM OF MOVEMENT
- TACTILE FEEL
- EASY TO DON AND DOFF



TECHNICAL FEATURES

Thickness	2 mm		
Sizes	XS/S	M/L	XL/XXL

AMARA 2MM

Code: 412722

- DURABLE AMARA ON PALMS AND FINGERS
- ADJUSTABLE VELCRO® BRAND FASTENER



TECHNICAL FEATURES

Thickness	2 mm						
Sizes	XXS	XS	S	M	L	XL	

FLEXA 3F 6.5

NEW

Code: 412732

- 6.5MM THREE-FINGER GLOVES, IDEAL FOR COLD WATER DIVES
- PRINT ON PALMS FOR ADDED GRIP
- COMFORTABLE ULTRASTRETCH NEOPRENE
- GAUNTLET CUFF WITH A VELCRO® BRAND CLOSURE STRAP



TECHNICAL FEATURES

Thickness	6.5mm			
Sizes	M	L	XL	XXL

FLEXA 3F 6.5 GLIDE

NEW

Code: 412733

- 6.5MM THREE-FINGER GLOVES, IDEAL FOR COLD WATER DIVES
- PRINT ON PALMS FOR ADDED GRIP
- COMFORTABLE ULTRASTRETCH NEOPRENE
- GLIDESKIN LINING ON WRISTS PROVIDES ADDITIONAL COMFORT AND WARMTH



TECHNICAL FEATURES

Thickness	6.5mm				
Sizes	S	M	L	XL	XXL

FLEXA 3F 6.5 KEV

NEW

Code: 412731

- 6.5MM THREE-FINGER GLOVES, IDEAL FOR COLD WATER DIVES
- DURABLE KEVLAR COATING, FROM THE TIPS OF THE FINGERS DOWN TO THE BASE OF THE PALM
- GAUNTLET CUFF WITH A VELCRO® BRAND CLOSURE STRAP



TECHNICAL FEATURES

Thickness	6.5mm				
Sizes	M	L	XL	XXL	3XL

FLEXA HOOD 6.5MM

Code: 412823

- A VENTING SYSTEM HELPS RELEASE AIR, OPTIMIZING EQUALIZATION AND COMFORT
- HOOD ATTACHMENT SYSTEM



TECHNICAL FEATURES

Thickness	6.5mm				
Sizes	XS	S	M	L	XL

EVOLUTION HOOD 7MM

NEW

Code: 412828

- EXTRA COMFORTABLE 7MM HOOD IN SUPER STRETCHY NEOPRENE
- GLIDESKIN LINING FOR A PERFECT SEAL AND ADDED COMFORT
- A DEDICATED VENT SYSTEM HELPS RELEASE AIR WHILE DIVING



TECHNICAL FEATURES

Thickness	7mm				
Sizes	XS	S	M	L	XL

EVOLUTION HOOD 5MM

Code: 412826

- EXTRA COMFORTABLE 5MM HOOD
- GLIDESKIN LINING FOR A PERFECT SEAL AND ADDED COMFORT
- A DEDICATED VENT SYSTEM HELPS RELEASE AIR WHILE DIVING



TECHNICAL FEATURES

Thickness	5mm				
Sizes	XS	S	M	L	XL

FLEXA DS 6.5MM

Code: 412638

- EXCLUSIVE DS DRAINAGE SYSTEM PREVENTS A VACUUM FORMING IN THE FOOTPOCKET
- EASY TO DON AND DOFF
- SUITABLE FOR LONGER WALKS TO DIVE SITES



TECHNICAL FEATURES

Thickness	6,5 mm							
Sizes	5	6	7	8	9	10	11	

CLASSIC NG 5MM

Code: 412634

- EASY DONNING AND DOFFING
- LIGHTWEIGHT - IDEAL FOR TRAVELLING
- ANTI-SLIP SOLE



TECHNICAL FEATURES

Thickness	5 mm										
Sizes	3	4	5	6	7	8	9	10	11	12	13

PURE 2MM

Code: 412639

- ANKLE BOOTS
- LIGHTWEIGHT, IDEAL FOR TRAVELING
- NON-SLIP SOLE



TECHNICAL FEATURES

Thickness	2 mm												
Sizes	3	4	5	6	7	8	9	10	11	12	13		

FLEXA DS 5MM

Code: 412637

- EXCLUSIVE DS DRAINAGE SYSTEM PREVENTS A VACUUM FORMING IN THE FOOTPOCKET
- EASY TO DON AND DOFF
- SUITABLE FOR LONGER WALKS TO DIVE SITES



TECHNICAL FEATURES

Thickness	5 mm												
Sizes	5	6	7	8	9	10	11	12	13				

EQUATOR 2MM

Code: 412636

- ANKLE BOOTS
- LIGHTWEIGHT, IDEAL FOR TRAVELING
- NON-SLIP SOLE



TECHNICAL FEATURES

Thickness	2 mm												
Sizes	3	4	5	6	7	8	9	10	11	12	13		

CLASSIC SOCKS 3MM

Code: 412635

- NO SOLE
- DOUBLE-LINED NEOPRENE
- CONTOURED CUT
- GLUED AND STITCHED SEAMS



TECHNICAL FEATURES

Thickness	3 mm						
Sizes	XXS	XS	S	M	L	XL	

SMART POCKET

Code: 412341

- CAN BE INSTALLED ON ALL NEW MARES SUITS FEATURING THE INTEGRATED SMART POCKET SYSTEM VIA AN EASY AND INTUITIVE CLIP SYSTEM
- INTEGRATED GRAPHIC PERFECTLY MATCHES ALL MARES SUITS
- GRIP PROTECTION SYSTEM TO AVOID LOOSENING WHEN DIVING OR DAMAGE TO THE SUIT



TIZIP LUBRICANT STICK

Code: 415728

- FOR SEMI-DRY AND DRY TIZIP
- TO PREVENT DRYING
- TO INCREASE DURABILITY



NEOPRENE GLUE

Code: 415108

- IDEAL FOR URGENT AND QUICK WETSUIT REPAIRS
- MADE IN COMPLIANCE WITH LATEST REGULATIONS
- 20ML



MINERAL TALCUM

Code: 415748 Desk Exhibitor (6pcs)

- HIGH QUALITY TALCUM TO PROTECT LATEX AND RUBBER PARTS
- IDEAL FOR MAINTENANCE AND THE CARE OF DRYSUITS AND WETSUITS
- MAKES DONNING SUITS EASIER
- PREVENTS IRRITATION
- 125G



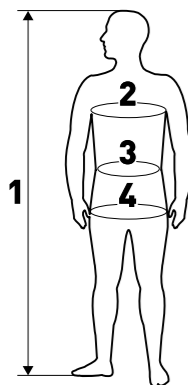

WETSUIT 5+/- MAN

IT	2	3	3W	3L	4	4W	4L	5	5W	5L	6	7	8
EU	S	M	MW	MLO	ML	MLW	MLLO	L	LW	LLO	XL	2XL	3XL
USA	S	M	SW	ST	M	MW	MT	L	LW	LT	XL	XXL	XXXL
1	175/5'9"	178/5'10"	178/5'10"	181/5'11"	181/5'11"	181/5'11"	184/6"	184/6"	184/6"	187/6'2"	187/6'2"	190/6'3"	193/6'4"
2	93/37"	97,5/38"	101,5/40"	97,5/38"	101,5/40"	105,5/42"	101,5/40"	105,5/42"	110/43"	105,5/42"	110/43"	114/45"	118/46"
3	73/29"	77,5/31"	81,5/32"	77,5/31"	81,5/32"	86/34"	81,5/32"	86/34"	90/35"	86/34"	90/35"	94/37"	98/39"
4	91/36"	95,5/38"	99,5/39"	95,5/38"	99,5/39"	104/41"	99,5/39"	104/41"	108/43"	104/41"	108/43"	112/44"	116/46"

WETSUIT 3 +/- MAN

IT	2	3	4	5	6	7	8
EU	S	M	ML	L	XL	2XL	3XL
USA	S	M	L	XL	XXL	XXXL	XXXL
1	176/5'9"	179/5'10"	182/6"	185/6'1"	188/6'2"	191/6'3"	194/6'4"
2	92/36"	96,5/38"	100,5/40"	105/41"	109/43"	113,5/45"	117,5/46"
3	71,5/28"	75,5/30"	80/32"	84/33"	88,5/35"	92,5/36"	97/38"
4	91/36"	95/37"	99,5/39"	103,5/41"	108/43"	112/44"	116/46"

WETSUIT 5 +/- SHE DIVES

IT	1	2	3	3W	3L	4	4W	4L	5	6	7
EU	XS	S	M	MW	MLO	L	LW	LLO	XL	2XL	3XL
USA	4	6	8	8W	8T	10	10W	10T	12	14	16
1	164/5'5"	167/5'6"	170/5'7"	170/5'7"	173/5'8"	173/5'8"	173/5'8"	176/5'9"	176/5'9"	179/5'10"	182/6"
2	77,5/31"	81,5/32"	85,5/34"	89,5/35"	85,5/34"	89,5/35"	95,3/37"	89,5/35"	95,3/37"	97,5/38"	101,5 / 40"
3	67/26"	71/28"	75/30"	79/31"	75/30"	79/31"	83/33"	79/31"	83/33"	87/34"	91/36"
4	84/33"	88/35"	92/36"	96/38"	92/36"	96/38"	100/39"	96/38"	100/39"	104/41"	108/43"

WETSUIT 3 +/- SHE DIVES

IT	1	2	3	4	5	6	7
EU	XS	S	M	L	XL	2XL	3XL
USA	4	6	8	10	12	14	16
1	163/5'4"	166/5'6"	169/5'7"	172/5'8"	175/5'9"	178/5'10"	181/5'10"
2	75/30"	79/31"	83/33"	87/34"	91/36"	95/37"	99/39"
3	66/26"	70/28"	74/29"	78/31"	82/32"	86/34"	90/35"
4	82/32"	86/34"	90/36"	94/37"	98/39"	102/40"	106/42"

SCUBA RANGER

	-3	-2	-1	0
1	119 / 47"	129 / 50"	140 / 55"	150 / 59"
2	59 / 23"	64 / 25"	70 / 27"	75 / 30"
3	55 / 21"	59 / 23"	63 / 24"	67 / 26"
4	65 / 26"	73 / 29"	77 / 30"	85 / 33"

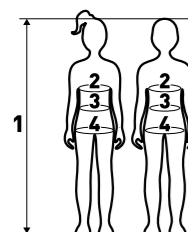
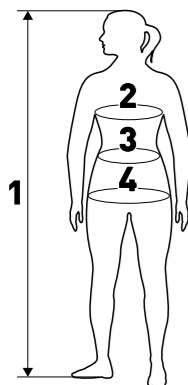

THERMO GUARD SHORTY UNISEX

IT	EU	CHEST	WAIST	HIPS	TOLERANCE
-3	8 A	56 / 22"	52 / 20"	66 / 26"	± 2 / ± 0.8"
-2	10 A	61 / 24"	56 / 22"	75 / 30"	± 2 / ± 0.8"
-1	12 A	67 / 26"	60 / 24"	79 / 31"	± 2 / ± 0.8"
0	14 A	73 / 29"	65 / 26"	87 / 34"	± 2 / ± 0.8"
1	XS	86 / 34"	65 / 26"	85 / 33"	± 2 / ± 0.8"
2	S	90 / 35"	70 / 28"	89 / 35"	± 2 / ± 0.8"
3	M	94 / 37"	74 / 29"	94 / 37"	± 2 / ± 0.8"
4	L	99 / 39"	78 / 31"	98 / 39"	± 2 / ± 0.8"
5	XL	103 / 41"	82 / 32"	102 / 40"	± 2 / ± 0.8"
6	XXL	107 / 42"	86 / 34"	106 / 42"	± 2 / ± 0.8"
7	3XL	111 / 44"	91 / 36"	111 / 44"	± 2 / ± 0.8"

NEOPRENE BOOTS

	EUROPE	USA	JAPAN
4XS	34/35	3	-
3XS	35/36	4	-
2XS	36/37	5	23 cm
XS	38	6	24 cm
S	39/40	7	25 cm
M	40/41	8	26 cm
L	41/42	9	27 cm
XL	43	10	28 cm
2XL	44/45	11	29 cm
3XL	45/46	12	-
4XL	47	13	-

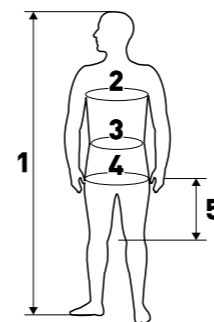

ULTRASKIN MAN

	S	M	L	XL	2XL	3XL
1	170.5-178 5'7"-5'10"	173-180.5 5'8"-5'11"	175.5-183 5'9"-6"	178-185.5 5'10"-6'1"	180.5-188 5'11"-6'2"	183-190.5 6'-6'3"
2	97 38.2"	104 40.9"	110 43.3"	116 45.7"	122 48"	128 50.4"
3	88 34.6"	95 37.4"	101 39.8"	107 42.1"	113 44.5"	119 46.8"
4	100 39.4"	107 42.1"	113 44.5"	119 46.8"	125 49.2"	131 51.6"
5	51 20.1"	53 20.9"	56 22"	59 23.2"	62 24.4"	65 25.6"

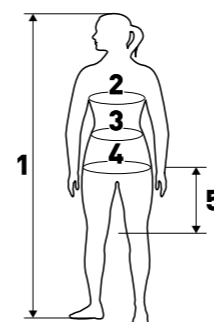

ULTRASKIN SHE DIVES

USA	XS	S	M	L	XL	2XL	3XL
	4	6	8	10	12	14	16
1	152.5-160 5'-5'3"	157.5-165 5'2"-5'5"	162.5-170 5'4"-5'7"	167.5-175.5 5'6"-5'9"	172.5-180.5 5'8"-5'11"	177.5-185.5 5'10"-6'1"	183 / 190.5 6' / 6'3"
2	88 34.6"	94 37"	100 39.4"	106 41.7"	112 44.1"	119 47"	125 49.2"
3	68 26.7"	74 29.1"	80 31.5"	86 33.8"	93 36.6"	99 39"	105 41.3"
4	96 37.7"	102 40.1"	109 42.9"	114 44.9"	121 47.6"	127 50"	133 52.4"
5	49 19.3"	52 20.5"	55 21.6"	57 22.4"	60 23.6"	62 24"	65 25.6"

ULTRASKIN ACCESSORIES

SOCKS	XS	S	M	L	XL	2XL	3XL
SHOE SIZE FEMALE (AU/US)	4-5	6-7	8-9	10-11	12-13		
SHOE SIZE MALE (AU/US)			6-7	8-9	10-11	12-13	14-15
EUROPE MALE/FEMALE	37-38	39	40-41	42	43-44	45-46	47-48

GLOVES	XS	S	M	L	XL	2XL
PALM CIRCUMFERENCE	19.5 7.5"	20.5 8"	21.5 8.5"	22.5 9"	23.5 9.5"	24.5 10"

How to measure gloves: measure circumference of your hand around your palm.

HOOD	XS	S	M	L	XL	2XL	3XL
FOREHEAD	46.5-48.5 18.3-19"	49-51 19.2-20"	51.5-53.5 20.7-21"	54-56 21.3-22"	56.5-58.5 22.2-23"	59-61 23.2-24"	61.5-63.5 24.2-25"

WETSUITS



Suit	Flexa Graphene		Ice Skin		Pro Therm		Flexa						
	Man	She Dives	Man	She Dives	Man	She Dives	Man	She Dives	Man	She Dives	Man	She Dives	
Model													
Code	412078	412079	412102	412103	412078	412079	412431	412432	412433	412434	412435	412436	
Thickness	7mm		7mm		8/7mm		8/6 mm		5/4 mm		3/2 mm		
Sizes*	2-3-3L-3W-4-4L-4W-5-5W-6-7	1-2-3-3L-3W-4-4L-4W-5	2-3-4-5-6-7	1-2-3-4-5	2-3-3L-3W-4-4L-4W-5-5L-5W-6-6L-6W-7-7W-8	1-2-2L-2W-3-3L-3W-4-4L-4W-5-6	2-3-3L-3W-4-4L-4W-5-5L-5W-6-6L-6W-7-7W-8	1-2-2L-2W-3-3L-3W-4-4L-4W-5-6	2-3-3L-3W-4-4L-4W-5-5L-5W-6-6L-6W-7-8	1-2-2L-2W-3-3L-3W-4-4L-4W-5-6	2-3-4-5-6-7	1-2-3-4-5	
For Cold Water	■		■		■		■		■		■		
For Temperate Water										■			
For Warm Water													■
Back Comfort System								■		■		■	
Instruments Grip	■		■		■		■		■		■		■
Masterseal Zip	■		■										
G-Lock Zipper													
S-Lock Zipper													
Tek-Flex Zipper							■						
Zippers on Ankles	■												
Double Cone	■												
Water Dam System							■						
Graphene Plush	■												
Thermo Plush				■			■		■		■		■
Integrated hood							■						
Hood Included	■		■										
Hood Keeper													■
Smart Pocket													■
Integrated Pocket	■		■				■		■		■		■



Suit	Evolution		Pioneer				Dual		Reef		Switch		Scuba Ranger			
	Man	She Dives	Man	She Dives	Man	She Dives	Man	She Dives	Man	She Dives	Man	She Dives	Jacket	Long John		
Model																
Code	412176	412177	412176	412177	412346	412347	412344	412345	412375	412376	412382	412383	412428	412429	412373	412374
Thickness	7mm		5mm		7mm		5mm		5mm		3mm		2.5mm		5mm	
Sizes*	2-3-3W-4-4L-4W-5-5L-5W-6-7-8	1-2-2L-2W-3-3L-3W-4-4L-4W-5-5W-6	2-3-3W-4-4L-4W-5-5L-5W-6-7-8	1-2-3-3L-3W-4-4L-4W-5-6	2-3-4-5-6-7-8	1-2-3-4-5	2-3-4-5-6-7-8	1-2-3-4-5	2-3-4-5-6-7	1-2-3-4-5	2-3-4-5-6-7-8	1-2-3-4-5-6	2-3-4-5-6-7-8	1-2-3-4-5-6	-3--2--1-0	
For Cold Water	■				■											
For Temperate Water				■				■		■						■
For Warm Water												■		■		
Instruments Grip	■		■		■		■		■		■					
Zippers on Ankles	■				■		■									■
Double Cone	■															
Integrated Hood									■							■
Hood Included																
Hood Keeper																

* L and W sizes are only available in selected countries



FINS



SIZE GUIDE

OPEN HEEL				410027	410025	410026	410019	410003	410001	410012
(UK)	(US)	(JP)	(EU)	AVANTI PURE	EXCITE	EXCITE PRO	X-STREAM	AVANTI QUATTRO+	PLANA AVANTI X3	AVANTI SUPERCHANNEL OH
11.5	12.5	19	30	XXS						
12.5	13.5	20	31							
0.5	1.5	21	32							
1	2	21.5	33	SM						
1.5	2.5	22	34							
2.5	3.5	22.5	35		XS	XS	XS	XS	XS	
3	4	23	36	ML						
4	5	23.5	37							
5	6	24	38		S	S	S	S	S	S
6	7	24.5	39	LXL						
6.5	7.5	25	40							
7.5	8.5	25.5	41		R	R	R	R	R	R
8	9	26	42	LXL						
9	10	26.5	43							
9.5	10.5	27	44							
10.5	11.5	27.5	45							
11	12	28	46							
12	13	28.5	47							
12.5	13.5	29	48							

FULL FOOTPOCKET				410346	410347	410313	410317	410302	410301
(UK)	(US)	(JP)	(EU)	AVANTI HC	AVANTI HC PRO	VOLO RACE	AVANTI SUPERCHANNEL FF	AVANTI TRE	AVANTI QUATTRO POWER
1.5	2.5	22	34						
2.5	3.5	22.5	35						
3	4	23	36						
4	5	23.5	37	036	036	036	036	036	
5	6	24	38						
6	7	24.5	39	038	038	038	038	038	
6.5	7.5	25	40						
7.5	8.5	25.5	41	040	040	040	040	040	040
8	9	26	42						
9	10	26.5	43	042	042	042	042	042	042
9.5	10.5	27	44						
10.5	11.5	27.5	45	044	044	044	044	044	044
11	12	28	46						
12	13	28.5	47	046	046	046	046	046	

FEATURES



HYPERCHANNEL

The latest development in Channel Thrust technology is the Hyperchannel: designed with two large, lateral, flexible areas and a rigid, flat, central part which interact, creating a curved channel. It provides an excellent ratio between thrust and effort.



SUPERCHANNEL

The blade is designed with a large, flexible, central Superchannel, propelling water-flow more efficiently down the fin blade instead of letting it spill over the sides. For optimal performance and minimal diver effort.



CHANNEL THRUST

This design is inspired by marine mammals. Channel Thrust technology maximizes the channeling of water and moves a much greater amount of water compared to other fins of the same size. The result is greater thrusting power with the same amount of effort.



OPB / OPTIMIZED PIVOTING BLADE

Allows the blade to maintain an optimal angle throughout the kicking cycle, whereas traditional fins only achieve this during a small portion of the cycle. OPB produces constant thrust, which minimizes fatigue and produces fluid movement through the water.



RIDDLED FOOTPOCKET

The limiting factors in traditional open heel foot pockets are their weight and the "parachute effect". When swimming, water gets into the space between the bootie and the foot pocket, creating drag like the air in a parachute. Perforations prevent this and have the additional benefit of making the foot pocket very soft and flexible. Furthermore, the suction effect which can make doffing the fins cumbersome is now a thing of the past.



RIBBED FOOTPLATE

The ribbed footplate facilitates the insertion of a boot into the fin, reducing friction between the outside and the footpocket's rubber parts. It also reduces suction effect and prevents the footpocket from flexing, thus transmitting more power to the blade.



EXCITE

Code: 410025 Excite

- INNOVATIVE MATERIALS FOR A MORE HARMONIOUS THRUST
- ENHANCED CHANNEL THRUST
- OPTIMIZED FOR LOW FATIGUE
- COLOR COORDINATED BUNGEE STRAP



COLOR VARIATIONS



TECHNICAL FEATURES

Sizes	XS	S	R	XL
Fit	34/37	37/41	41/44	44/48
Blade	36cm 14.1in	39cm 15.3in	40cm 15.7in	40cm 15.7in

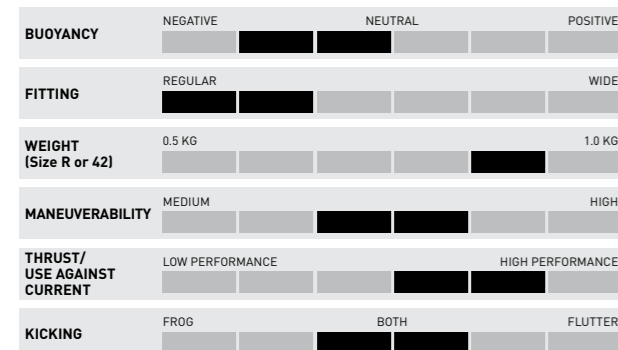

EXCITE PRO

Code: 410026 Excite Pro

- INNOVATIVE MATERIALS FOR A MORE HARMONIOUS THRUST
- ENHANCED CHANNEL THRUST
- OPTIMIZED FOR MAXIMUM THRUST
- COLOR COORDINATED BUNGEE STRAP



COLOR VARIATIONS



TECHNICAL FEATURES

Sizes	XS	S	R	XL
Fit	34/37	37/41	41/44	44/48
Blade	36cm 14.1in	39cm 15.3in	40cm 15.7in	40cm 15.7in

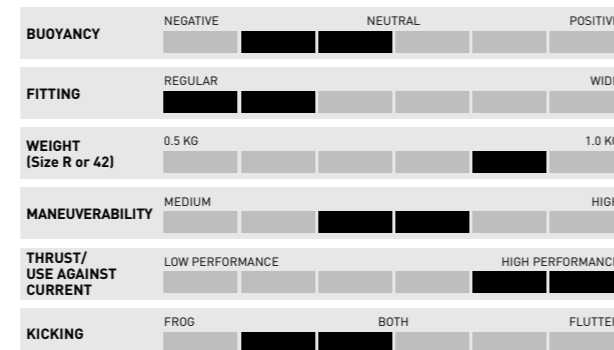

X-STREAM

Code: 410019

- BUNGEE STRAP
- RIDDLED FOOT POCKET AVOIDS "PARACHUTE EFFECT"
- NEXT GENERATION OPB
- TRI-MATERIAL BLADE CONSTRUCTION REDUCES TURBULENCE
- CHANNEL THRUST TECHNOLOGY



COLOR VARIATIONS



TECHNICAL FEATURES

Sizes	XS	S	R	XL
Fit	34/37	37/41	41/44	44/48
Blade	34.5cm 13.6in	36cm 14.2in	37cm 14.6in	38cm 15in

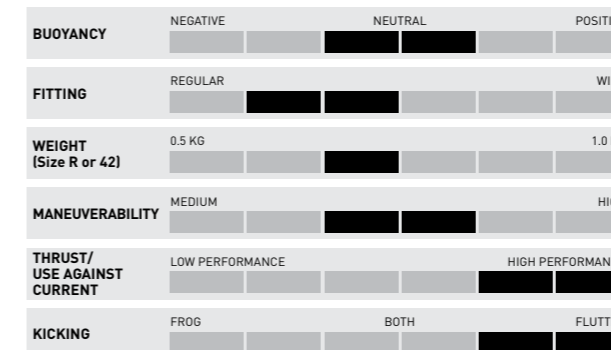

* ABS Buckle

AVANTI QUATTRO +

Code: 410003

- BUNGEE STRAP
- HI-FLEX MATERIAL OPTIMIZES BLADE'S EFFICIENCY
- 4 CHANNELS FOR GREATER THRUSTING POWER
- STABILIZING TRIM TABS



COLOR VARIATIONS



TECHNICAL FEATURES

Sizes	XS	S	R	XL
Fit	34/37	37/41	41/44	44/48
Blade	33cm 13in	37cm 14.6in	38cm 15in	39cm 15.3in

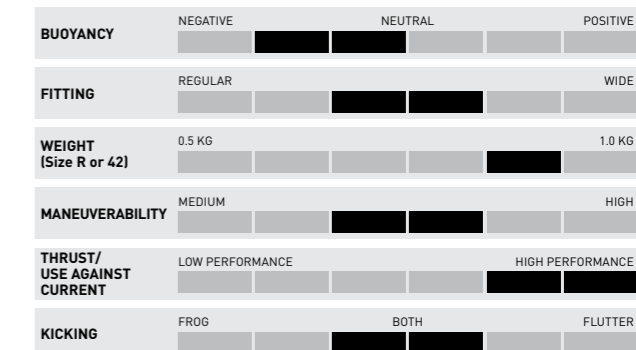

AVANTI SUPERCHANNEL OH

Code: 410012

- BUNGEE STRAP
- ANATOMICAL OPEN HEEL FOOT POCKET
- 3 CHANNEL DESIGN FOR ADDED PROPULSION
- RUGGED AND DURABLE CONSTRUCTION



COLOR VARIATIONS



TECHNICAL FEATURES

Sizes	S	R	XL
Fit	37/41	41/44	44/48
Blade	35cm 13.8in	37cm 14.6in	37cm 14.6in



AVANTI PURE

Code: 410027

- A 2-MATERIAL, OPEN HEEL FIN
- CAN BE USED BAREFOOT OR WITH MARES PURE BOOTIES
- SOFT AND COMFORTABLE FOOT POCKET
- ERGONOMIC HEEL PAD (PATENT PENDING) MINIMIZES PRESSURE ON THE ACHILLES TENDON
- SPECIAL BUNGEE STRAP FOR MAXIMUM COMFORT DURING USE, WHEN DONNING AND DOFFING
- THE LOOPS ON THE FOOT POCKET MAINTAIN THE STRAP IN THE CORRECT POSITION



COLOR VARIATIONS

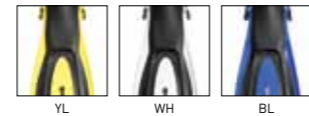

TECHNICAL FEATURES

Sizes	XXS	SM	ML	LXL
Fit	30/34	35/38	39/43	44/47
Blade	27cm 10.6in	29.5cm 11.6in	32cm 12.6in	34.5cm 13.6in



AVANTI PURE

Dual-material fin with an exceptionally soft and comfortable open heel. Soft blade in Tecralene®, with Channel Thrust effect.



Ergonomic heel reinforcement

A soft and ergonomic heel reinforcement reduces pressure on the Achilles tendon to a minimum, making this fin suitable for use with bare feet or a light boot, such as Pure Boots 412639.



Strap retainers on the foot pocket

Strap retainers on the foot pocket serve as guides to keep the strap in the right place.



Adjustable elastic strap

A unique elastic strap makes it easy to put on and adjust to your exact needs.



Rubber bungee with flat heel reinforcement

Alternatively, the fin can be fitted with Bungee Strap 415363, suitable for use with a thick boot.

SCAN THE QR CODE



TO SEE OUR BUNGEE STRAP VIDEO GUIDES

AVANTI HC PRO

Code: 410347

- ERGONOMIC FOOT POCKET. THE LATERAL RIB DISCHARGES PRESSURE IN LINE WITH THE FOOT, PREVENTING LATERAL COMPRESSION
- HYPERCHANNEL-INDUCED THRUST EFFECT WITH AN INCREASED PERFORMANCE/EFFORT RATIO
- RIDGES ON THE BACK OF THE BLADE: REINFORCE THE BLADE WHILE OPTIMIZING PIVOTING GEOMETRY
- OVERMOLDING ON THE BACK RIB FURTHER OPTIMIZES THRUST AND PERFORMANCE



COLOR VARIATIONS



TECHNICAL FEATURES

Sizes	036	038	040	042	044	046
Blade	32.5cm 12.8in	34.5cm 13.5in	36cm 14.2in	38cm 15in	40cm 15.7in	42cm 16.5in

BUOYANCY	NEGATIVE		NEUTRAL		POSITIVE	
FITTING	REGULAR			WIDE		
WEIGHT (Size R or 42)	0.5 KG		1.0 KG			
MANEUVERABILITY	MEDIUM			HIGH		
THRUST/ USE AGAINST CURRENT	LOW PERFORMANCE			HIGH PERFORMANCE		
KICKING	FROG		BOTH		FLUTTER	

AVANTI HC

Code: 410346

- ERGONOMIC FOOT POCKET. THE LATERAL RIB DISCHARGES PRESSURE IN LINE WITH THE FOOT, PREVENTING LATERAL COMPRESSION
- HYPERCHANNEL-INDUCED THRUST EFFECT WITH AN INCREASED PERFORMANCE/EFFORT RATIO
- RIDGES ON THE BACK OF THE BLADE: REINFORCE THE BLADE WHILE OPTIMIZING PIVOTING GEOMETRY



COLOR VARIATIONS



TECHNICAL FEATURES

Sizes	036	038	040	042	044	046
Blade	32.5cm 12.8in	34.5cm 13.5in	36cm 14.2in	38cm 15in	40cm 15.7in	42cm 16.5in

BUOYANCY	NEGATIVE		NEUTRAL		POSITIVE	
FITTING	REGULAR			WIDE		
WEIGHT (Size R or 42)	0.5 KG		1.0 KG			
MANEUVERABILITY	MEDIUM			HIGH		
THRUST/ USE AGAINST CURRENT	LOW PERFORMANCE			HIGH PERFORMANCE		
KICKING	FROG		BOTH		FLUTTER	

VOLO RACE

Code: 410313

- ANATOMICAL FOOT POCKET
- OPB SYSTEM FOR EASY KICKING EFFICIENCY
- CHANNEL THRUST TECHNOLOGY



COLOR VARIATIONS



TECHNICAL FEATURES

Sizes	036	038	040	042	044	046
Blade	33.5cm 13.2in	33.5cm 13.2in	36.5cm 14.5in	37cm 14.6in	39.5cm 15.6in	39.5cm 15.6in

BUOYANCY	NEGATIVE		NEUTRAL		POSITIVE	
FITTING	REGULAR			WIDE		
WEIGHT (Size R or 42)	0.5 KG		1.0 KG			
MANEUVERABILITY	MEDIUM			HIGH		
THRUST/ USE AGAINST CURRENT	LOW PERFORMANCE			HIGH PERFORMANCE		
KICKING	FROG		BOTH		FLUTTER	

AVANTI QUATTRO POWER

Code: 410301

- ANATOMICAL FOOT POCKET
- RUBBERIZED SIDE RIBS
- 4 CHANNELS FOR GREATER THRUSTING POWER
- LONG BLADE, IDEAL FOR BOTH SCUBA AND APNEA



COLOR VARIATIONS



TECHNICAL FEATURES

Sizes	040	042	044	046
Blade	44cm 17.3in	45.5cm 17.9in	45.5cm 17.9in	45.5cm 17.9in

BUOYANCY	NEGATIVE		NEUTRAL		POSITIVE	
FITTING	REGULAR			WIDE		
WEIGHT (Size R or 42)	0.5 KG		1.0 KG			
MANEUVERABILITY	MEDIUM			HIGH		
THRUST/ USE AGAINST CURRENT	LOW PERFORMANCE			HIGH PERFORMANCE		
KICKING	FROG		BOTH		FLUTTER	

AVANTI SUPERCHANNEL FF

Code: 410317

- ORTHOPEDIC FOOT POCKET
- TECRALENE BLADE FOR SUPERIOR PERFORMANCE AND DURABILITY
- 3 CHANNEL DESIGN FOR ADDED PROPULSION



COLOR VARIATIONS



TECHNICAL FEATURES

Sizes	036	038	040	042	044	046
Blade	32cm 12.6in	33cm 13in	34cm 13.4in	35.5cm 14in	36.5cm 14.5in	37cm 14.6in

BUOYANCY	NEGATIVE		NEUTRAL		POSITIVE	
FITTING	REGULAR			WIDE		
WEIGHT (Size R or 42)	0.5 KG		1.0 KG			
MANEUVERABILITY	MEDIUM		HIGH			
THRUST/ USE AGAINST CURRENT	LOW PERFORMANCE			HIGH PERFORMANCE		
KICKING	FROG		BOTH		FLUTTER	

AVANTI TRE

Code: 410302

- ORTHOPEDIC FOOT POCKET
- 3 CHANNELS FOR MAXIMUM THRUST
- MID-SIZE BLADE WITH DURABLE CONSTRUCTION
- STABILIZING TRIM TABS



COLOR VARIATIONS

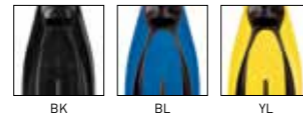

TECHNICAL FEATURES

Sizes	036	038	040	042	044	046
Blade	31cm 12.2in	33cm 13in	34cm 13.4in	36cm 14.2in	36.5cm 14.5in	37.5cm 14.8in

BUOYANCY	NEGATIVE		NEUTRAL		POSITIVE	
FITTING	REGULAR			WIDE		
WEIGHT (Size R or 42)	0.5 KG		1.0 KG			
MANEUVERABILITY	MEDIUM		HIGH			
THRUST/ USE AGAINST CURRENT	LOW PERFORMANCE			HIGH PERFORMANCE		
KICKING	FROG		BOTH		FLUTTER	

BUNGEE STRAP

Code: 415363 (PAIR)



- SMART ALTERNATIVE TO STEEL SPRING STRAPS
- 3 SIZES: XS/S - R - XL
- 6 COLOR OPTIONS: BK-WH-BL-YL-LM-AQ
- 2 EXTENSIONS FOR A BETTER FIT
- ERGONOMIC HEEL COVER
- WIDE LOOP TO BE USED EVEN WITH THICK GLOVES



ABS PLUS BUCKLES

Code: 415337 (PAIR)

- USER FRIENDLY BUCKLE SYSTEM
- EASY DONNING AND DOFFING WITH THICK GLOVES
- CAN BE MOUNTED ON ALL MARES OPEN HEEL FINs



FIN STRAP

Code: 415120

- UNIVERSAL FIN STRAP FOR OPEN HEEL FINs
- WIDTH: 30 MM/1.2 IN - LENGTH: 460 MM/18.1 IN
- HIGH QUALITY VULCANIZED RUBBER MATERIAL



FINS



Fins	Excite Pro	Excite	X-Stream	Avanti Quattro +	Avanti Superchannel OH	Avanti Pure	Avanti HC Pro	Avanti HC	Volo Race	Avanti Quattro Power	Avanti Superchannel FF	Avanti Tre
Code	410026	410025	410019	410003	410012	410027	410347	410346	410313	410301	410317	410302
Sizes	XS S R XL		XS S R XL	XS S R XL	S R XL	XXS SM ML LXL	036 038 040 042 044 046	036 038 040 042 044 046	036 038 040 042 044 046	040 042 044 046	036 038 040 042 044 046	036 038 040 042 044 046
Colors	○ GR	● BL ● YL	● BL ● JPK** ● TBK ○ WH ● YL	● RBL ● RYL ○ WH ● BK ● LM ● FL ● AQ	● BK ● BL ● YL	● BL ○ WH ● YL	● BKB ● BKR ● BKY ● WHB ● WHG ● WHP	● BL ○ GR ● YL	● BGR ● BL ● YL	● BK	● BL ○ WH ● YL	● BK ● BL ● YL
OPB	■		■						■			
Channel Thrust	■		■	■	■	■	■	■	■	■	■	■
Tri-Material Construction			■				■					
Thermoplastic Rubber / Technopolymers	■		■						■			
Thermoplastic Rubber / Tecralene				■	■	■	■	■		■	■	■
Blade* Length	40cm 15.7in		37cm 14.6in	38cm 15in	37cm 14.6in	32cm 12.6in	38cm 15in	38cm 15in	37cm 14.6in	45.5cm 17.9in	35.5cm 14in	36cm 14.2in
Open Heel (Size R)												
Full Foot (Size 42)	800cm ² 124in ²		750cm ² 116.3in ²	780cm ² 120.9in ²	730cm ² 113.1in ²	550cm ² 85.2in ²	750cm ² 116.2in ²	750cm ² 116.2in ²	680cm ² 105.4in ²	960cm ² 148.8in ²	650cm ² 100.7in ²	680cm ² 105.4in ²
Weight one fin without buckles (Size R or 42/43)	0.9kg 2lb		0.7kg 1.5lb	0.9kg 2lb	0.9kg 2lb	0.6kg 1.4lb	0.7kg 1.5lb	0.7kg 1.5lb	0.7kg 1.5lb	1kg 2.2lb	0.7kg 1.5lb	0.6kg 1.3lb



MASKS & SNORKELS



* From end of footpocket to end of blade
** ABS Buckle

CHROMA UP



Fitting

The new silicone skirt with an exclusive fit is derived from the original X-Vision mask, a cornerstone in the history of Mares.



Low-profile frame

The low-profile frame increases the field of vision to the side and upward.



Buckles

Rugged buckles with large buttons make it easy to adjust even when wearing gloves.



Chrome inserts and soft over-molding

Mask with tri-material frame. The polycarbonate structure is enhanced with stiff chrome elements and a soft grip insert in the middle.



Quick lens replacement system

The side buttons make it quick to replace the lenses, and no tools are required. The mask fits optical lenses 411193.



DISCOVER MORE



SCAN THE QR CODE TO SEE OUR OPTICAL LENS INSTALLING VIDEO GUIDE

CHROMA UP

Code: 411066

- TRI-MATERIAL FRAME WITH CHROME PLATED COMPONENTS AND A SOFT INSERT
- INCREASED OPTICAL CONE AND FIELD OF VISION TOWARDS THE TOP
- QUICK RELEASE LENS SYSTEM: INCLUDES A SMART MECHANISM (PATENT PENDING) TO REPLACE LENSES WITHOUT TOOLS
- MONO SILICONE SKIRT

X-VISION CHROME LIQUIDSKIN

Code: 411065

- CHROME PLATED FRAME
- BI-SILICONE SKIRT CONTOURED FOR ENHANCED FIT AND COMFORT
- LOW DRAG DESIGN
- SMALL RIBS AROUND NOSE TO RELIEVE PRESSURE
- X-SHAPED BI-SILICONE STRAP



COLOR VARIATIONS



COLOR VARIATIONS



ACCESSORIES

Optical lens	code 411193: from -1.0 to -5.5 and +1.5 to +3.0*
--------------	--

ACCESSORIES

Optical lens	code 411194: from -1.0 to -6.5 and +1.5 to +3.0*
--------------	--

*Our optical lenses conform to norm EN 16805. They are not medical devices.

X-VISION ULTRA LIQUIDSKIN

Code: **411052**

Code: **411052 - Mirrored lenses**

- ULTRA CLEAR SKIRT (CLYLWCL, CLBLWCL)
- MIRRORED GOLD LENSE INCREASES VISIBILITY IN CLOUDY WATERS (G0GRKGRK)
- MIRRORED SILVER LENSE REDUCES THE REFLECTION OF SHALLOW WATER OR SANDY SEABED (SIGRKGK)
- BI-SILICONE SKIRT CONTOURED FOR ENHANCED FIT AND COMFORT
- LOW DRAG DESIGN
- SMALL RIBS AROUND NOSE TO RELIEVE PRESSURE
- FIELD OF VISION 20% WIDER THAN PREVIOUS VERSION
- X-SHAPED BI-SILICONE STRAP



COLOR VARIATIONS



COLOR VARIATIONS MIRRORED



ACCESSORIES

Optical lens code 411194: from -1.0 to -6.5 and +1.5 to +3.0 [excludes Mirrored versions]*

X-VISION

Code: **411053**

- ULTRA-CLEAR SILICONE
- LOW DRAG DESIGN
- SMALL RIBS AROUND NOSE TO RELIEVE PRESSURE
- FIELD OF VISION 20% WIDER THAN PREVIOUS VERSION
- X-SHAPED SILICONE STRAP
- OPTICAL LENSES AVAILABLE



COLOR VARIATIONS

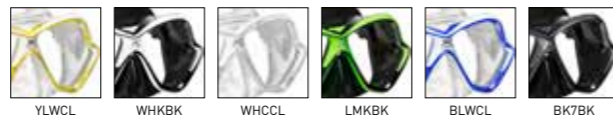

ACCESSORIES

Optical lens code 411194: from -1.0 to -6.5 and +1.5 to +3.0*

*Our optical lenses conform to norm EN 16805. They are not medical devices.

X-VISION MID 2.0

Code: **411067**

- BI-MATERIAL FRAME
- MEDIUM SIZED SILICONE SKIRT
- WIDE VIEWING ANGLE
- OPTICAL LENSES AVAILABLE



COLOR VARIATIONS

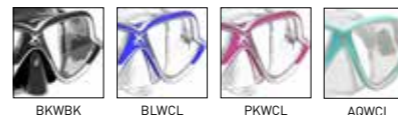

ACCESSORIES

Optical lens code 411186 from +1.5 to +3.0 and code 411187 from -1.5 to -7.0*

*Our optical lenses conform to norm EN 16805. They are not medical devices.

ONE VISION

Code: **411046**

Code: **411047 Sunrise**

- SILICONE SKIRT
- LOW DRAG DESIGN
- SMALL RIBS AROUND NOSE TO RELIEVE PRESSURE
- SINGLE LENS DESIGN
- X-SHAPED SILICONE STRAP
- SUNRISE VERSION AVAILABLE



COLOR VARIATIONS

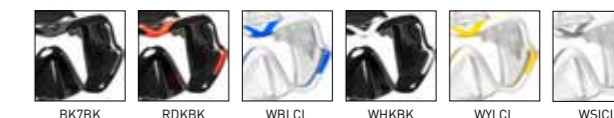

COLOR VARIATIONS SUNRISE



COMET

Code: **411059**

- MONOLENS MASK FOR CHILDREN
- SILICONE SKIRT
- AMPLE FIELD OF VISION
- LIGHTWEIGHT
- STRAP WITH QUICK-RELEASE BUCKLES



COLOR VARIATIONS

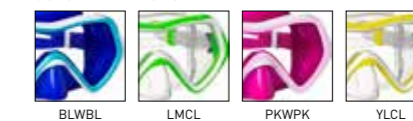

PURE WIRE

Code: 411069



- INTERCHANGEABLE, BI-MATERIAL FRAME
- SOFT WIRED SKIRT PORTION PROVIDES SUPPORT AND ENHANCES GRIP WHEN FITTING MASK
- EXTREMELY COMFORTABLE SILICONE SKIRT SUITED TO A VARIETY OF FACE SHAPES

PURE WIRE FRAME

Code: 415103



- INTERCHANGEABLE, BI-MATERIAL FRAME
- MAKES IT POSSIBLE TO CUSTOMIZE THE LOOK OF THE PURE WIRE MASK
- A SOFT SECTION PROVIDES EXTRA SUPPORT FOR THE SKIRT



COLOR VARIATIONS



GRYBK GRRBK WHGBK BLGCL GRYCL

COLOR VARIATIONS

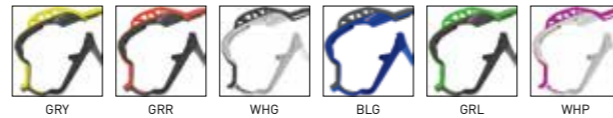

GRY GRR WHG BLG GRL WHP



WHA

PURE WIRE

The Pure Wire mask pairs the prominent features of a frameless mask with a lightweight frame, made in dual materials. The soft and reticulated section of the frame supports the skirt, while increasing grip during placement and equalizing of the mask.



FITTING

New Super-Fit silicone skirt adapts to all facial types.

INTERCHANGEABLE FRAME

The frame is interchangeable and lets you personalize the color of your mask. It is easy to replace with no need for tools. Seven color options are available (code 415103).

BUCKLES

The pivoting buckles are located on the skirt for improved comfort.

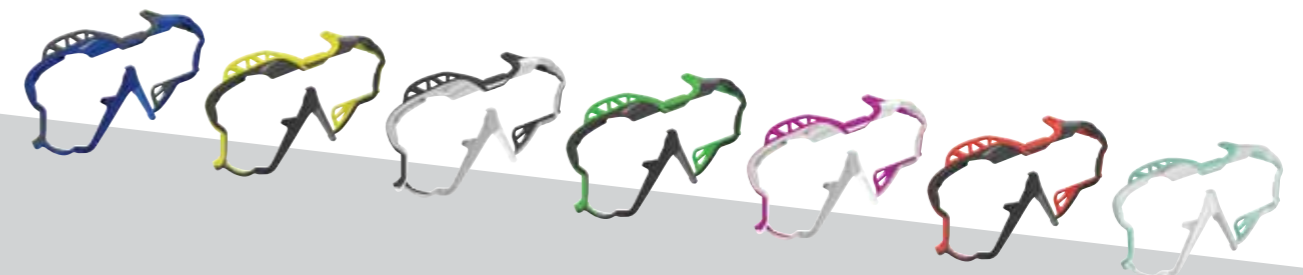

ESSENCE LIQUIDSKIN

Code: 411031

- BI-SILICONE SKIRT FOR UNMATCHED COMFORT
- LIGHT AND FOLDABLE, ALSO IDEAL AS SPARE MASK
- AMPLE FIELD OF VISION
- X-SHAPED BI-SILICONE STRAP
- SINGLE LENS DESIGN



COLOR VARIATIONS

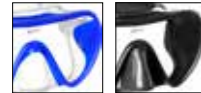

CLBL BKBK

TROPICAL

Code: 411246

- FRAMELESS SILICONE MASK
- ULTRA COMFORTABLE SKIRT
- BUCKLES WITH LARGE BUTTONS



COLOR VARIATIONS



BLBL RDRD WHWH PKPK BKBK CLCL

X-WIRE

Code: 411068

- BI-MATERIAL FRAME WITH SOFT, WIRED PORTION
- SOFT WIRE PROVIDES SKIRT SUPPORT AND ENHANCES GRIP WHEN FITTING MASK
- EXTREMELY COMFORTABLE SILICONE SKIRT SUITED TO A VARIETY OF FACE SHAPES



COLOR VARIATIONS



BWBK GMBK PKWBK BLBL GRYCL

I3

Code: 411040

Code: 411042 Sunrise

- SILICONE SKIRT
- SMALL RIBS AROUND NOSE TO RELIEVE PRESSURE
- GREAT PERIPHERAL VISION
- X-SHAPED SILICONE STRAP
- SUNRISE VERSION AVAILABLE



COLOR VARIATIONS



BWHCL BBKPK BRDBK

COLOR VARIATIONS SUNRISE



BWHCL BBKPK BRDBK

JUNO

Code: 411056

- FRAMELESS MONOLENS MASK
- SILICONE SKIRT
- SAME STYLE AS THE JUPITER BUT WITH A REGULAR SKIRT FIT
- PIVOTING BUCKLES ON RIGID INSERTS AT THE SIDES OF THE LENS
- GREAT FIELD OF VISION



COLOR VARIATIONS



WHBK RDBK LMBK WHBL RDWH BLWH



WHCL

JUPITER

Code: 411057

- FRAMELESS MONOLENS MASK
- SILICONE SKIRT
- SAME STYLE AS THE JUNO BUT WITH AN "XL" SKIRT FIT FOR BIGGER FACES
- PIVOTING BUCKLES ON RIGID INSERTS AT THE SIDES OF THE LENS
- GREAT FIELD OF VISION



COLOR VARIATIONS



WHBK BLBK BKWH RDWH

SPYDER

Code: 411074

- FRAME WITH SOFT WIRED NOSE BRIDGE FOR ENHANCED GRIP WHEN FITTING THE MASK AND EQUALIZING
- EXTREMELY COMFORTABLE SILICONE SKIRT
- SIDE NOSE AREA SHAPED FOR EASIER EQUALIZING



COLOR VARIATIONS



WHKPK RDKPK WHBCL

SEALHOUETTE

Code: 411058

- BI-LENS MASK
- SILICONE SKIRT
- REDUCED DISTANCE BETWEEN LENSES AND EYES
- AMPLE FIELD OF VISION
- LIGHTWEIGHT
- SOFT SILICONE BUCKLES
- BUCKLES ON SKIRT



COLOR VARIATIONS



LMBK WHBL RDWH BKWH PKWH

X-FREE

Code: 411060

- RIGID FRAME AND ANATOMICAL SKIRT OVERMOLDED IN SILICONE
- MINIMUM DISTANCE BETWEEN LENS AND EYES
- AMPLE FIELD OF VISION
- LIGHTWEIGHT
- ERGONOMIC MASK STRAP BUCKLES FOR EASY OPERATION
- RAISED TEXTURE ON THE SIDES OF THE NOSE



COLOR VARIATIONS



TANA

Code: 411055

- SILICONE SKIRT
- SOFT TOUCH INSERTS ON THE FRAME FOR GRIP
- LIGHTWEIGHT
- SIDE GUSSETS AT THE NOSE TO FACILITATE EQUALIZING



COLOR VARIATIONS



EDGE

Code: 411070

- STREAMLINED BI-MATERIAL FRAME
- SOFT AREAS FOR ENHANCED GRIP WHEN FITTING THE MASK
- STURDY, DURABLE CONSTRUCTION
- INTEGRATED BUCKLES ON FRAME
- EXTREMELY COMFORTABLE SILICONE SKIRT SUITED TO A VARIETY OF FACE SHAPES



COLOR VARIATIONS

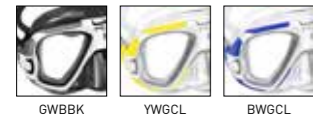

PURE EDGE

Code: 411071

- STREAMLINED BI-MATERIAL FRAME
- SOFT AREAS FOR ENHANCED GRIP WHEN FITTING THE MASK
- STURDY, DURABLE CONSTRUCTION
- INTEGRATED BUCKLES ON FRAME
- EXTREMELY COMFORTABLE SILICONE SKIRT SUITED TO A VARIETY OF FACE SHAPES*



COLOR VARIATIONS



OPERA

Code: 411019

- SILICONE SKIRT
- STURDY AND DURABLE CONSTRUCTION
- OVAL SHAPED SILICONE STRAP
- OPTICAL LENSES AVAILABLE



COLOR VARIATIONS



ACCESSORIES

Optical lens	code 411182: from -1.0 to -5.5*
--------------	---------------------------------

*Our optical lenses conform to norm EN 16805. They are not medical devices.



MASK STRAP LIQUIDSKIN

Code: **415115 White**

Code: **415116 Black**

- MASK STRAP FOR LIQUIDSKIN MASKS
- WIDTH: 14 MM/0.55 IN - LENGTH: 580 MM/22.8 IN
- BI-SILICONE MATERIAL



MASK STRAP

Code: **415105 CLEAR**

Code: **415106 Black**

- UNIVERSAL MASK STRAP
- WIDTH: 14 MM/0.55 IN - LENGTH: 560 MM/22.0 IN
- SILICONE MATERIAL



STRAP COVER

Code: **412901**

Code: **412902 She Dives**

- ONE SIZE FITS ALL
- SOFT NEOPRENE MASK STRAP COVER
- HELPS TO KEEP THE MASK STRAP IN PLACE
- HIGH COMFORT
- TANGLE-FREE DIVE



ANTIFOG

Code: **415101**

- GEL TO PREVENT MASK LENSES FROM FOGGING UP
- OPEN/CLOSE CAP WITH BRUSH
- MADE IN COMPLIANCE WITH LATEST REGULATIONS
- 60ML



REBEL DRY

Code: **411487**

- 100% DRY TOP
- SLIDING SNORKEL KEEPER
- CORRUGATED SILICONE HOSE AND MOUTHPIECE
- EXHAUST VALVE
- SUITABLE FOR DIVING OR EXTENDED SNORKELING SESSIONS
- MOUTHPIECE MOUNTED ON A RIGID SECTION WITH A LARGE INTERNAL VOLUME, ENSURES UNBEATABLE BREATHING CHARACTERISTICS



COLOR VARIATIONS



BKLM BKBL BKRD BKWH

REBEL SPLASH

Code: **411488**

- SEMIDRY TOP WITH ANTI SPLASH
- SLIDING SNORKEL KEEPER
- CORRUGATED SILICONE HOSE AND MOUTHPIECE
- EXHAUST VALVE
- SUITABLE FOR DIVING OR EXTENDED SNORKELING SESSIONS
- MOUTHPIECE MOUNTED ON A RIGID SECTION WITH A LARGE INTERNAL VOLUME, ENSURES UNBEATABLE BREATHING CHARACTERISTICS



COLOR VARIATIONS



BKWH WHBK WHAQ

REBEL FLEX

Code: **411489**

- SLIDING SNORKEL KEEPER
- CORRUGATED SILICONE HOSE AND MOUTHPIECE
- EXHAUST VALVE
- SUITABLE FOR DIVING OR EXTENDED SNORKELING SESSIONS
- MOUTHPIECE MOUNTED ON A RIGID SECTION WITH A LARGE INTERNAL VOLUME, ENSURES UNBEATABLE BREATHING CHARACTERISTICS



COLOR VARIATIONS

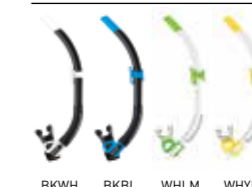

BKWH BKBL WHLM WHYL

ERGO DRY

Code: 411481

- 100% DRY TOP
- SLIDING SWIVEL SNORKEL KEEPER
- CORRUGATED SILICONE HOSE AND MOUTHPIECE
- EXHAUST VALVE
- SUITABLE TO LONGER SNORKELING SESSIONS OR EXTENDED PERIODS ON THE SURFACE



ERGO SPLASH

Code: 411480

- SEMIDRY TOP WITH ANTI-SPLASH
- SLIDING SWIVEL SNORKEL KEEPER
- CORRUGATED SILICONE HOSE AND MOUTHPIECE
- EXHAUST VALVE
- SUITABLE TO LONGER SNORKELING SESSIONS OR EXTENDED PERIODS ON THE SURFACE



COLOR VARIATIONS



ERGO FLEX

Code: 411482

- SLIDING SWIVEL SNORKEL KEEPER
- CORRUGATED SILICONE HOSE AND MOUTHPIECE
- EXHAUST VALVE
- SUITABLE TO LONGER SNORKELING SESSIONS OR EXTENDED PERIODS ON THE SURFACE



COLOR VARIATIONS



COLOR VARIATIONS



SNORKEL @

Code: 411479



- ERGONOMIC SHAPE
- ROLL UP, COMPACT DESIGN
- FITS IN A BCD POCKET OR CAN BE ATTACHED TO A BC
- ALL SILICONE DESIGN FOR FLEXIBILITY AND DURABILITY
- TUBE TOP DESIGN MADE TO PREVENT WATER ENTRY WHILE SNORKELING
- IDEAL FOR TRAVELLING



COLOR VARIATIONS



PRO FLEX

Code: 411460

- BI-MATERIAL SOFT CONSTRUCTION
- CURVED, ERGONOMIC STRUCTURE
- NO AIRFLOW INTERRUPTIONS TO REDUCE NOISE AND VIBRATIONS
- SLIDING KEEPER
- SILICONE MOUTHPIECE FOR EXTENDED USE



PLUTO

Code: 411486

- 100% DRY TOP SNORKEL DEDICATED TO JUNIORS
- SLIDING SNORKEL KEEPER
- SILICONE MOUTHPIECE
- EXHAUST VALVE
- WHISTLE ON BOTTOM AS SAFETY DEVICE



COLOR VARIATIONS

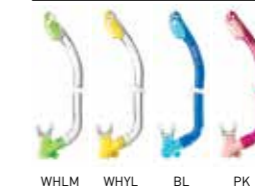

MASKS



Mask	Chroma Up	X-Vision Ultra Liquidskin		X-Vision Chrome Liquidskin	X-Vision	X-Vision Mid 2.0	One Vision		Comet	X-Wire	Pure Wire
Code	411066	411052 Regular	411052 Mirrored	411065	411053	411067	411046 Regular	411047 Sunrise	411059	411068	411069
Colors	<ul style="list-style-type: none"> BKYBK BLWCL WHKBK WHACL 	<ul style="list-style-type: none"> CLBLWBLW CLBLWCBL CLGRKGRK CLRDKRDK CLWHKWHK CLYLKYLK CLYLWCYL 	<ul style="list-style-type: none"> GGRKGRK SIGRKRK 	<ul style="list-style-type: none"> CLWHKWHK CLYLKYLK 	<ul style="list-style-type: none"> BK7BK BLWCL LMKBK WHKBK YLWCL 	<ul style="list-style-type: none"> AQWCL BKWBK BLWCL PKWCL 	<ul style="list-style-type: none"> BK7BK RDKBK WBLCL WHKBK WSICL WYLC 	<ul style="list-style-type: none"> BLWBL LMCL PKWPK YLCL 	<ul style="list-style-type: none"> BLGCL GRRBK GRYBK GRYCL WHGBK 	<ul style="list-style-type: none"> BLGCL GRRBK GRYBK GRYCL WHGBK 	<ul style="list-style-type: none"> BLGCL GRRBK GRYBK GRYCL WHGBK
Liquidskin		■		■							
Sunrise								■			
Monolens									■		■
Bilens	■				■	■				■	
Tri-Comfort								■			
Optical lens (optional)	code 411193: from -1.0 to -5.5 and +1.5 to +3.0	code 411194: from -1.0 to -6.5 and +1.5 to +3.0	NO	code 411194: from -1.0 to -6.5 and +1.5 to +3.0	code 411194: from -1.0 to -6.5 and +1.5 to +3.0	code 411186: from +1.5 to +3.0 and code 411187: from -1.5 to -7.0		NO	NO	NO	NO



Mask	Essence Liquidskin	Tropical	Juno	Jupiter	I3		Spyder	Sealhouette	X-Free	Tana	Edge	Pure Edge	Opera
Code	411031	411246	411056	411057	411040 Regular	411042 Sunrise	411074	411058	411060	411055	411070	411071	411019
Colors	<ul style="list-style-type: none"> BKGR CLBL 	<ul style="list-style-type: none"> BKBK BLBL PKPK RDRD WHWH CLCL 	<ul style="list-style-type: none"> BLWH LMBK RDBK RDWH WHBK WHBL WHCL 	<ul style="list-style-type: none"> BKWH BLBK RDWH WHBK 	<ul style="list-style-type: none"> BBKBK BRDBK BWHCL 	<ul style="list-style-type: none"> BBKBK BRDBK BWHCL 	<ul style="list-style-type: none"> RDKBK WHBCL WHKBK 	<ul style="list-style-type: none"> BKWH LMBK PKWH RDWH WHBL YLBK 	<ul style="list-style-type: none"> BLWH LMBK PKWH WHBK YLBK 	<ul style="list-style-type: none"> PKWWH PUWWH 	<ul style="list-style-type: none"> BWGCL GWBBK YWGCL 	<ul style="list-style-type: none"> BKLBK BKWBK BKYBK WBLCL 	<ul style="list-style-type: none"> RBLCL TBKBK
Liquidskin	■					■							
Sunrise						■							
Monolens	■	■	■	■	■							■	
Bilens							■	■	■	■	■		■
Tri-Comfort						■							
Optical lens (optional)	NO	NO	NO	NO	NO	NO	NO	NO	NO	NO	NO	NO	code 411182: from -1.0 to -5.5

SNORKELS



Snorkel	Rebel Dry	Rebel Splash	Rebel Flex	Ergo Dry	Ergo Splash	Ergo Flex	Snorkel @	Pro Flex	Pluto
Code	411487	411488	411489	411481	411480	411482	411479	411460	411486
Colors	<ul style="list-style-type: none"> BKBL BKLM BKRD BKWH 	<ul style="list-style-type: none"> BKWH WHAQ WHBK 	<ul style="list-style-type: none"> BKBL BKWH WHLM WHYL 	<ul style="list-style-type: none"> BK BLM BRD BWH BYL CL JKP RBL RYL WH 	<ul style="list-style-type: none"> BK CL RBL RYL 	<ul style="list-style-type: none"> BK RBL RD RYL 	<ul style="list-style-type: none"> BK WH 	<ul style="list-style-type: none"> BK 	<ul style="list-style-type: none"> BL PK WHLM WHYL
Dry Top	■			■					■
Purge Valve	■	■	■	■	■	■			■



ACCESSORIES



EOS 32LRZ

Code: 415647

LED BATTERY CHARGE INDICATOR
RECHARGEABLE BATTERY
ZOOMABLE LIGHT BEAM

- XHP50 LED
- SINGLE-LED WITH LENS
- MAGNETIC ADJUSTABLE FOCUS, FROM NARROW TO WIDE LIGHT BEAM
- VISUAL BATTERY CHARGE INDICATOR
- 135 MINUTES OF BURN TIME (MAX POWER)
- IN-HOUSE RECHARGEABLE BATTERY
- USB CHARGING CABLE
- VISUAL LED CHARGE INDICATOR
- WIDE LIGHT BEAM
- MULTIFUNCTIONAL MECHANICAL SWITCH
- AN „ELECTRONIC LOCK“ SYSTEM PREVENTS THE TORCH FROM BEING ACCIDENTALLY SWITCHED ON - DOUBLE CLICK THE SWITCH TO TURN ON THE TORCH
- FOUR OPTIONS: ON, LOW, FLASH, OFF
- ONE-HAND USE
- TUBULAR HANDLE
- ADJUSTABLE WRIST STRAP
- PADDED CASE WITH ZIP

EOS 20LRZ

Code: 415646

LED BATTERY CHARGE INDICATOR
RECHARGEABLE BATTERY
ZOOMABLE LIGHT BEAM

- 3 KW CSLPM1.TG LEDES
- MAGNETIC ADJUSTABLE FOCUS, FROM NARROW TO WIDE LIGHT BEAM
- VISUAL BATTERY CHARGE INDICATOR
- 100 MINUTES OF BURN TIME (MAX POWER)
- IN-HOUSE RECHARGEABLE BATTERY
- USB CHARGING CABLE
- VISUAL LED CHARGE INDICATOR
- WIDE LIGHT BEAM
- MULTIFUNCTIONAL MECHANICAL SWITCH
- AN „ELECTRONIC LOCK“ SYSTEM PREVENTS THE TORCH FROM BEING ACCIDENTALLY SWITCHED ON - DOUBLE CLICK THE SWITCH TO TURN ON THE TORCH
- FOUR OPTIONS: ON, LOW, FLASH, OFF
- ONE-HAND USE
- TUBULAR HANDLE
- ADJUSTABLE WRIST STRAP
- PADDED CASE WITH ZIP

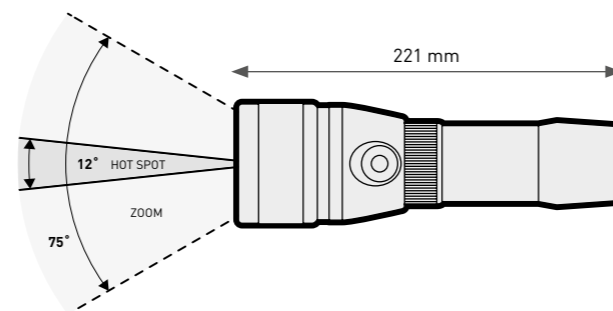
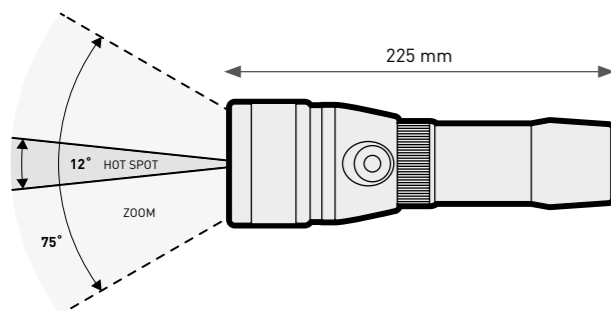

TECHNICAL FEATURES

Bulb	1* XHP50 LED Chip		
	High	Low	Flash/SOS
Switch Mode	High	Low	Flash/SOS
Led lumens (25°)	3200	930	/
Burn time (min)	135	265	145
Color Temperature	5700-7800		
Light beam (1m distance)	Hot Spot (12°)	Corona (75°)	
	(mm/in)	300mm / 11.8in	1350mm / 53in
Rechargeable Batteries	1 x ICR26800		
Time to charge	7h (5V1A adapter) - 14h (PC 500mA)		
Total length	225mm / 8.8in		
Head diameter	62mm / 2.4in		
Body diameter	34mm / 1.3in		
Weight with batteries	605g / 21oz		
Max. operation depth	120m / 393ft		

TECHNICAL FEATURES

Bulb	3 KW CSLPM1.TG-LEDS		
	High	Low	Flash/SOS
Switch Mode	High	Low	Flash/SOS
Led lumens (25°)	2300	670	/
Burn time (min)	100	210	200
Color Temperature	5700-7800		
Light beam (1m distance)	Hot Spot (12°)	Corona (75°)	
	(mm/in)	230mm / 9.0in	1400mm / 55in
Rechargeable Batteries	1 x ICR26800		
Time to charge	7h (5V1A adapter) - 14h (PC 500mA)		
Total length	221mm / 8.7in		
Head diameter	62mm / 2.4in		
Body diameter	34mm / 1.3in		
Weight with batteries	594g / 20.7oz		
Max. operation depth	120m / 393ft		



DISCOVER MORE

EOS LRZ

We have decided it is time to see things more clearly! The new line of EOS LRZ torches is a true, new offering in the landscape of torches; featuring characteristics that are unique to the market, at competitive prices. Beyond the option of adjusting the beam of light to meet your needs and diving conditions; the new EOS LRZs now uses a mechanical, multifunction switch, with a battery charge indicator. It is extremely useful to always know the power level of your battery, especially during the dive! Safe and user-friendly, the switch is waterproof and with a simple touch it commands the torch in four different ways: maximum power on the first press, about 40% power on the second press, a flashing strobe on the third and lastly 'off' on the fourth. The battery can be charged anywhere using a USB cable

connected to a computer or adapter. The new battery charger, boasts a power level indicator, intuitively showing when charging is complete. Its ease of use is guaranteed by the tubular grip, making it possible to manage the torch with one hand. Included is an adjustable strap ensuring a more secure grip. Durable and wear-resistant, EOS LRZ torches are made of anodized aluminum and have a new EOS Family Look. Finally... EOS LRZ torches stand apart from the crowd due to the innovative temperature control system, allowing for use out of the water. All Eos versions are fitted with a padded, zippered case, made of exceptionally durable and long-lasting material for increased protection. No disposable packaging as part of our green initiatives.



“ELECTRONIC” SWITCH LOCK SYSTEM prevents from accidental switch-on

MULTIFUNCTION SWITCH with different options of use: High 100%, Low 40% and Flash



VISUAL BATTERY INDICATOR: have always under control the charge of the battery



BUILT-IN RECHARGEABLE USB SYSTEM

LED CHARGE INDICATOR: helps to easily understand when the battery is charged



EOS 15LRZCode: **415645**LED BATTERY CHARGE INDICATOR
RECHARGEABLE BATTERY
ZOOMABLE LIGHT BEAM

- 3 X 1580 LUMEN XP-G2 CREE LEDS
- MAGNETIC ADJUSTABLE FOCUS, FROM NARROW TO WIDE LIGHT BEAM
- VISUAL BATTERY CHARGE INDICATOR
- 125 MINUTES OF BURN TIME (MAX POWER)
- IN-HOUSE RECHARGEABLE BATTERY
- USB CHARGING CABLE
- VISUAL LED RECHARGE INDICATOR
- WIDE LIGHT BEAM
- MULTIFUNCTIONAL MECHANICAL SWITCH
- AN „ELECTRONIC LOCK“ SYSTEM PREVENTS THE TORCH FROM BEING ACCIDENTALLY SWITCHED ON - DOUBLE CLICK THE SWITCH TO TURN ON THE TORCH
- FOUR OPTIONS: ON, LOW, FLASH, OFF
- ONE-HAND USE
- TUBULAR HANDLE
- ADJUSTABLE WRIST STRAP
- PADDED CASE WITH ZIP

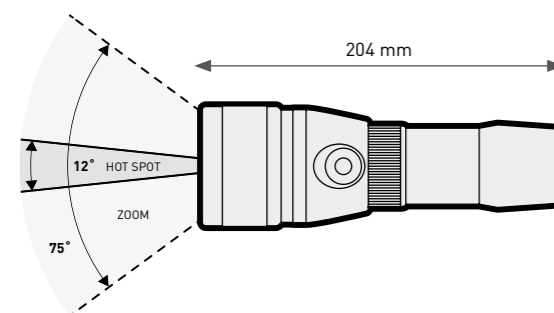
**TECHNICAL FEATURES**

Bulb	3 Cree XP-G2 LED Chip		
	High	Low	Flash/SOS
Switch Mode	High	Low	Flash/SOS
Led lumens (25°)	1580	500	/
Burn time (min)	125	180	175
Color Temperature	5800-7300		
Light beam (1m distance)	Hot Spot (12°)	Corona (75°)	
(mm/in)	230mm / 9.0in	1550mm / 61in	
Rechargeable Batteries	1 x ICR26650		
Time to charge	6 h (5V1A adapter) - 12 h (PC 500mA)		
Total length	204mm / 8.0in		
Head diameter	62mm / 2.4in		
Body diameter	34mm / 1.3in		
Weight with batteries	556.8g / 19.5oz		
Max. operation depth	120m / 393ft		

EOS 10LRZCode: **415644**LED BATTERY CHARGE INDICATOR
RECHARGEABLE BATTERY
ZOOMABLE LIGHT BEAM

- 1100 LUMEN XML-2 CREE LED
- SINGLE-LED WITH LENS
- MAGNETIC ADJUSTABLE FOCUS, FROM NARROW TO WIDE LIGHT BEAM
- VISUAL BATTERY CHARGE INDICATOR
- 150 MINUTES OF BURN TIME (MAX POWER)
- IN-HOUSE RECHARGEABLE BATTERY
- USB CHARGING CABLE
- VISUAL LED CHARGE INDICATOR
- WIDE LIGHT BEAM
- MULTIFUNCTIONAL MECHANICAL SWITCH
- AN „ELECTRONIC LOCK“ SYSTEM PREVENTS THE TORCH FROM BEING ACCIDENTALLY SWITCHED ON - DOUBLE CLICK THE SWITCH TO TURN ON THE TORCH
- FOUR OPTIONS: ON, LOW, FLASH, OFF
- ONE-HAND USE
- TUBULAR HANDLE
- ADJUSTABLE WRIST STRAP
- PADDED CASE WITH ZIP

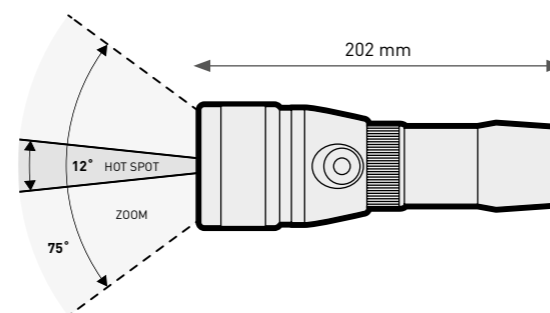
**TECHNICAL FEATURES**

Bulb	1*XML-2 Cool white LED Chip		
	High	Low	Flash/SOS
Switch Mode	High	Low	Flash/SOS
Led lumens (25°)	1100	360	/
Burn time (min)	150	210	195
Color Temperature	5800-7300		
Light beam (1m distance)	Hot Spot (12°)	Corona (75°)	
(mm/in)	220mm / 8.6in	1550mm / 61in	
Rechargeable Batteries	1 x ICR26650		
Time to charge	6 h (5V1A adapter) - 12 h (PC 500mA)		
Total length	202mm / 7.9in		
Head diameter	57mm / 2.2in		
Body diameter	34mm / 1.3in		
Weight with batteries	543.8g / 19oz		
Max. operation depth	120m / 393ft		

EOS 5LRZCode: **415640**LED BATTERY CHARGE INDICATOR
RECHARGEABLE BATTERY
ZOOMABLE LIGHT BEAM

- 520 LUMEN XP-G2 CREE LED
- SINGLE-LED
- MAGNETIC ADJUSTABLE FOCUS, FROM NARROW TO WIDE LIGHT BEAM
- VISUAL BATTERY CHARGE INDICATOR
- 135 MINUTES OF BURN TIME (MAX POWER)
- IN-HOUSE RECHARGEABLE BATTERY
- USB CHARGING CABLE
- VISUAL LED CHARGE INDICATOR
- WIDE LIGHT BEAM
- MULTIFUNCTIONAL MECHANICAL SWITCH
- AN „ELECTRONIC LOCK“ SYSTEM PREVENTS THE TORCH FROM BEING ACCIDENTALLY SWITCHED ON - DOUBLE CLICK THE SWITCH TO TURN ON THE TORCH
- FOUR OPTIONS: ON, LOW, FLASH, OFF
- ONE-HAND USE
- TUBULAR HANDLE
- ADJUSTABLE WRIST STRAP
- PADDED CASE WITH ZIP

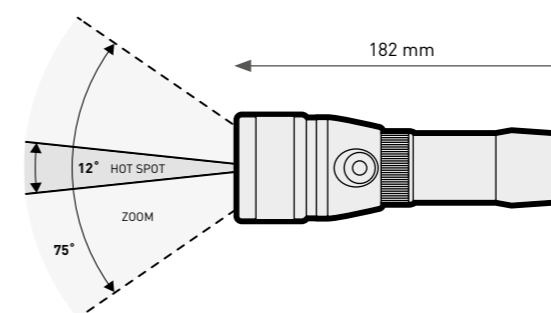
**TECHNICAL FEATURES**

Bulb	1 Cree XP-G2 LED Chip		
	High	Low	Flash/SOS
Switch Mode	High	Low	Flash/SOS
Led lumens (25°)	520	160	/
Burn time (min)	135	375	390
Color Temperature	5800-7300		
Light beam (1m distance)	Hot Spot (12°)	Corona (75°)	
(mm/in)	220mm / 8.6in	1550mm / 61in	
Rechargeable Batteries	1 x ICR18650		
Time to charge	4 h 30' (5V1A adapter) - 6 h (PC 500mA)		
Total length	182mm / 7.2in		
Head diameter	43mm / 1.7in		
Body diameter	26mm / 1.0in		
Weight with batteries	300g / 10.5oz		
Max. operation depth	120m / 393ft		

EOS STROBECode: **415693**LED BATTERY CHARGE INDICATOR
RECHARGEABLE BATTERY
ZOOMABLE LIGHT BEAM

- 450 LUMENS
- 360° HIGH VISIBILITY
- 15/20 HOURS OF BURN TIME
- IN-HOUSE RECHARGEABLE BATTERY
- USB RECHARGEABLE CABLE
- LED CHARGE INDICATOR
- MAGNETIC, ROTATIONAL SWITCH
- TWO OPERATING MODES: ON, STROBE
- ANODIZED ALUMINUM HOUSING
- ADJUSTABLE STRAP
- PADDED CASE WITH ZIP

**TECHNICAL FEATURES**

Bulb	1 Cree XPG2 LED Chip	
	High	Flash/SOS
Switch Mode	High	Flash/SOS
Led lumens (25°)	450	/
Burn time (min)	300	1500
Color Temperature	5800-7300	
Light beam (1m distance)	Diffused light	
Flash rate (p/min)	120	
Rechargeable Batteries	1 x ICR26650	
Time to charge	6h (5V1A adapter) - 12h (PC 500mA)	
Total length	170mm / 6.6in	
Head diameter	39mm / 1.6in	
Body diameter	34mm / 1.4in	
Weight with batteries	245g / 8.6oz	
Max. operation depth	100m / 328ft	

EOS 10LRWCode: **415642**

LED BATTERY CHARGE INDICATOR
RECHARGEABLE BATTERY
WIDE LIGHT BEAM

- 1000 LUMEN CREE LED
- WIDE LIGHT BEAM
- EXCELLENT FOR VIDEO AND PHOTOGRAPHY
- VISUAL BATTERY CHARGE INDICATOR
- IN-HOUSE RECHARGEABLE BATTERY
- USB CHARGING CABLE
- VISUAL LED CHARGE INDICATOR
- MULTIFUNCTIONAL MECHANICAL SWITCH
- AN „ELECTRONIC LOCK“ SYSTEM PREVENTS THE TORCH FROM BEING ACCIDENTALLY SWITCHED ON - DOUBLE CLICK THE SWITCH TO TURN ON THE TORCH
- FOUR OPTIONS: ON, LOW, SOS, OFF
- VERY COMPACT AND LIGHTWEIGHT
- ADJUSTABLE WRIST STRAP
- PADDED CASE WITH ZIP

**TECHNICAL FEATURES**

Bulb	XM-L2		
	High	Low	Flash/SOS
Switch Mode	High	Low	Flash/SOS
Led lumens (25°)	1000	500	1000
Burn time (min)	90	150	240
Color Temperature	5800-7300		
Light beam (1m distance)	Wide Spot (120°)		
(mm/in)	2500mm / 98.4in		
Rechargeable Batteries	1 x ICR18650		
Time to charge	300min		
Total length	148.11mm / 5.8in		
Head diameter	28mm / 1.1in		
Body diameter	26mm / 1in		
Weight with batteries	178g / 6.3oz		
Max. operation depth	100m / 328ft		

EOS 10LRCode: **415641**

LED BATTERY CHARGE INDICATOR
RECHARGEABLE BATTERY

- 1000 LUMEN CREE LED
- POWERFUL LIGHT BEAM
- PERFECT AS BACK-UP
- VISUAL BATTERY CHARGE INDICATOR
- IN-HOUSE RECHARGEABLE BATTERY
- USB CHARGING CABLE
- VISUAL LED CHARGE INDICATOR
- MULTIFUNCTIONAL MECHANICAL SWITCH
- AN „ELECTRONIC LOCK“ SYSTEM PREVENTS THE TORCH FROM BEING ACCIDENTALLY SWITCHED ON - DOUBLE CLICK THE SWITCH TO TURN ON THE TORCH
- FOUR OPTIONS: ON, LOW, SOS, OFF
- HANDY AND COMPACT
- ADJUSTABLE WRIST STRAP
- PADDED CASE WITH ZIP

**TECHNICAL FEATURES**

Bulb	SST40 LED		
	High	Low	Flash/SOS
Switch Mode	High	Low	Flash/SOS
Led lumens (25°)	1000	500	1000
Burn time (min)	90	150	240
Color Temperature	5800-7300		
Light beam (1m distance)	Hot Spot (12°)		
(mm/in)	220mm / 8.6in		
Rechargeable Batteries	1 x ICR18650		
Time to charge	300min		
Total length	158.7mm / 6.2in		
Head diameter	28mm / 1.1in		
Body diameter	26mm / 1in		
Weight with batteries	188.5g / 6.6oz		
Max. operation depth	100m / 328ft		

EOS 10LRW - VIDEO SETCode: **415643**

LED BATTERY CHARGE INDICATOR
RECHARGEABLE BATTERY
WIDE LIGHT BEAM

- COMPLETE SET FOR VIDEO MAKING AND PHOTOGRAPHY
- COMPACT AND LIGHTWEIGHT
- 2 EOS 10LRW TORCHES
- USB CHARGING CABLES
- ALUMINUM TRAY FOR ATTACHING A VIDEO CAMERA
- FLEXIBLE ARMS WITH CONNECTIONS FOR THE EOS 10RW
- DEDICATED PADDED CASE WITH ZIP
- CAMERA NOT INCLUDED

**TORCH ADAPTER**Code: **415179**

- TURN THE TORCH INTO A VIDEO LIGHT
- DESIGNED FOR FLEXIBLE ARM
- A QUICK, EASY AND RELIABLE SOLUTION
- 3 SIZES (S/21 MM - M/27MM - L/34 MM)
- STAINLESS STEEL WITH RUBBER PROTECTION



The connector between the flexible arm and torch adapter is not included.

SOFT GOODMAN HANDLECode: **415180**

- ADJUSTABLE HAND STRAP TO BE USED EVEN WITH THICK GLOVES
- SAFETY WRIST STRAP FOR A PERFECT FIT
- DOUBLE ADJUSTABLE VELCRO® BRAND FASTENERS
- CAN BE USED WITH ALL EOS LIGHTS
- RELIABLE AND STURDY MATERIAL
- ADDITIONAL D-RING TO SECURE THE TORCH

**MARKER BEAM**Code: **415711**

- FLASHING LIGHT STICK
- SAFETY LEASH WITH STOP
- LR 44 BATTERIES



CRUISE BACKPACK PRO

Code: 415464



- TELESCOPING HANDLE
- LARGE STURDY WHEELS
- EXTERNAL FIN POCKETS WITH DRAINAGE SYSTEM
- ADJUSTABLE EXTERNAL COMPRESSION STRAPS
- BICOLOR, ULTRALIGHT BUCKLES
- AIR MESH HANDLE
- PADDED SHOULDER STRAPS
- INTEGRATED FRONT POCKETS WITH ZIP
- SIDE HANDLES
- A.T.O. - AIR TRAVEL OPTIMIZED

**TECHNICAL FEATURES**

Dimensions (LxWxH)	Unit Net Weight	Volume
47 x 32 x 81cm / 18.5 x 12.5 x 32in	5kg / 11lb	128l / 7811in ³

CRUISE BACKPACK

Code: 415465



- TELESCOPING HANDLE
- LARGE STURDY WHEELS
- EXTERNAL FIN POCKETS WITH DRAINAGE SYSTEM
- ADJUSTABLE EXTERNAL COMPRESSION STRAPS
- BICOLOR, ULTRALIGHT BUCKLES
- AIR MESH HANDLE
- PADDED SHOULDER STRAPS
- INTEGRATED FRONT POCKETS WITH ZIP
- SIDE HANDLES
- A.T.O. - AIR TRAVEL OPTIMIZED

**TECHNICAL FEATURES**

Dimensions (LxWxH)	Unit Net Weight	Volume
40 x 31 x 80cm / 16 x 12 x 31.5in	4.4kg / 9.7lb	100l / 6071in ³

CRUISE BACKPACK ROLLER

Code: 415466



- EASY TO FOLD AND STOW
- LARGE STURDY WHEELS
- EXTERNAL FIN POCKETS WITH DRAINAGE SYSTEM
- ADJUSTABLE EXTERNAL COMPRESSION STRAPS
- BICOLOR, ULTRALIGHT BUCKLES
- AIR MESH HANDLE
- PADDED SHOULDER STRAPS
- INTEGRATED FRONT POCKETS
- LIGHTWEIGHT
- A.T.O. - AIR TRAVEL OPTIMIZED

**TECHNICAL FEATURES**

Dimensions (LxWxH)	Unit Net Weight	Volume
47 x 32 x 81cm / 18.5 x 12.5 x 32in	3kg / 6.6lb	128l / 7811in ³

CRUISE BUDDY

Code: 415467



- TELESCOPING HANDLE
- WIDE WHEEL BASE FOR STABILITY
- ADJUSTABLE EXTERNAL COMPRESSION STRAPS
- TWO AIR MESH HANDLES
- INTEGRATED FRONT POCKETS WITH ZIPPERS
- ADJUSTABLE INTERNAL TIE-DOWN STRAPS
- BICOLOR, ULTRALIGHT BUCKLES
- BUSINESS CARD WINDOWS
- LIGHTWEIGHT
- A.T.O. - AIR TRAVEL OPTIMIZED

**TECHNICAL FEATURES**

Dimensions (LxWxH)	Unit Net Weight	Volume
43 x 27 x 75cm / 17 x 10.5 x 29.5in	3.5kg / 7.7lb	87l / 5309in ³

CRUISE CAPTAIN

Code: 415472



- TELESCOPING HANDLE
- WIDE WHEEL PLACEMENT
- EXPANDABLE POCKET WITH ZIPPER
- INTEGRATED FRONT POCKET
- WIDE INTERNAL MESH POCKET
- COMPRESSION STRAPS WITH BICOLOR, ULTRALIGHT BUCKLES
- TOP AND LATERAL SIDE AIR MESH HANDLES
- A.T.O. - AIR TRAVEL OPTIMIZED

**TECHNICAL FEATURES**

Dimensions (LxWxH)	Unit Net Weight	Volume
36 x 22 x 55cm / 14 x 8.5 x 22in	2.8kg / 6.2lb	42l / 2563in ³

CRUISE BACKPACK MESH ELITE

Code: 415477

- CAN BE FOLDED INTO A SMALL BAG WITH HANDLE
- LIGHTWEIGHT
- INTEGRATED SOFT HANDLE
- BOTTOM PROTECTION
- INTERNAL POCKET
- WIDE EXTERNAL POCKET
- BOTTOM EXTENSION WITH DRAINAGE HOLE
- ADJUSTABLE SHOULDER STRAPS

**TECHNICAL FEATURES**

Dimensions (LxWxH)	Unit Net Weight	Volume
39 x 39 x 74cm / 15.5 x 15.5 x 29in	0.5kg / 1.1lb	114l / 6956in ³

CRUISE BACKPACK MESH DELUXE

Code: 415476

- STURDY PVC MESH NET
- ADJUSTABLE SHOULDER AND STERNUM STRAP
- LATERAL ZIP AND STURDY HANDLE
- BOTTOM PROTECTION
- INTERNAL POCKET
- WIDE EXTERNAL POCKET
- BOTTOM EXTENSION WITH DRAINAGE HOLE
- DRAWSTRING CLOSURE

**TECHNICAL FEATURES**

Dimensions (LxWxH)	Unit Net Weight	Volume
41 x 41 x 75cm / 16 x 16 x 29.5in	1.2kg / 2.6lb	123.5l / 7536in ³

CRUISE X-STRAP

Code: 415469



- EASY TO FOLD
- TWO LARGE INTEGRATED POCKETS
- BICOLOR, ULTRALIGHT BUCKLES
- NEOPRENE HANDLES
- ADJUSTABLE, PADDED AND REMOVABLE SHOULDER STRAPS
- AUTO-BLOCKING ZIP
- EXTREMELY LIGHTWEIGHT

**TECHNICAL FEATURES**

Dimensions (LxWxH)	Unit Net Weight	Volume
76 x 31 x 33cm / 30 x 12 x 13in	1.2kg / 2.6lb	76l / 4637in ³

CRUISE CLASSIC

Code: 415473



- HANDLE AND SHOULDER STRAPS
- EXTERNAL FIN POCKET WITH BUCKLE
- ZIP POCKET FOR PERSONAL BELONGINGS
- STURDY AND LIGHTWEIGHT
- REINFORCED BOTTOM



TECHNICAL FEATURES

Dimensions (LxWxH)	Unit Net Weight	Volume
76 x 29 x 36cm / 30 x 11.5 x 14in	2kg / 4.4lb	79l / 4821in ³

CRUISE JOURNEY

Code: 415470



- STYLISH DESIGN
- A CONCEPT FOR DAILY USE, THE OFFICE AND LEISURE
- ADJUSTABLE PADDED SHOULDER STRAPS
- DEDICATED LAPTOP POCKET WITH ZIP
- MULTIUSE ZIPPERED POCKETS
- EXPANDABLE SIDE POCKET
- BICOLOR, ULTRALIGHT BUCKLES
- SHOE COMPARTMENT
- WIDE STRAP TO ALLOW FOR ATTACHMENT TO A TELESCOPIC HANDLE
- CARRYING HANDLE
- ULTRALIGHT MATERIAL
- A.T.O. - AIR TRAVEL OPTIMIZED



TECHNICAL FEATURES

Dimensions (LxWxH)	Unit Net Weight	Volume
31 x 20 x 56cm / 12.2 x 8 x 22in	1.2kg / 2.6lb	35l / 2135in ³

CRUISE POOL

Code: 415468



- EXTREMELY LIGHTWEIGHT
- EXTERNAL ZIP POCKET
- REINFORCED BOTTOM
- WIDE, LONG STRAP



TECHNICAL FEATURES

Dimensions (LxWxH)	Unit Net Weight	Volume
69 x 26 x 29cm / 27 x 10 x 11in	0.7kg / 1.5lb	50l / 3057in ³

CRUISE BEACH

Code: 415506

- ADJUSTABLE SHOULDER STRAP
- CARRY HANDLE
- TWO OUTER POCKETS WITH ZIP CLOSURE
- MESH AREAS FOR BETTER AIR CIRCULATION
- LARGE OPENING FOR EASY ACCESS
- EXTREMELY LIGHT
- IDEAL FOR SNORKELING



TECHNICAL FEATURES

Dimensions (LxWxH)	Unit Net Weight	Volume
73 x 27 x 17cm / 28.7 x 10.6 x 6.7in	0.43kg / 0.95lb	31l / 1891in ³

CRUISE DRY ROLLER

140 L / 8544 in³

The Cruise Dry Roller is a waterproof duffel bag with wheels that can be rolled along or used as a backpack thanks to its ergonomic shoulder straps.

It has a **rigid base with a supportive structure and heavy-duty rubber wheels**. The material is water-repellent and all metal components are made of rustproof stainless steel.

The folding closure system helps you to easily store your dive equipment and close it according to the volume needed.

The **internal mesh pocket with zip** is very useful for safely organizing your diving equipment and the two **VELCRO® Brand fastener straps included inside the bag** help to secure your dive gear for safer transportation. **The bottom layer of the bag can easily be raised** for drying purposes and any necessary checks.

The Cruise Dry Roller 140 is a smart, versatile bag to carry your diving equipment safely and comfortably.

All details have been studied to meet a diver's needs.



- CAPACITY: 140 l
- DIMENSIONS (LXWXH): 100 X 33 X 65 cm
- UNIT NET WEIGHT: 2.3 kg

CRUISE DRY ROLLER**NEW**

Code: 415485



- WATERPROOF DUFFLE BAG WITH WHEELS FOR EASY TRANSPORTATION
- FOLDING CLOSURE SYSTEM
- ERGONOMIC SHOULDER STRAPS FOR CARRYING AS A BACKPACK
- LARGE EXTERNAL WATERPROOF POCKET
- INTERNAL MESH POCKET TO SAFELY STORE SMALL ITEMS
- THE BOTTOM LAYER OF THE BAG CAN BE RAISED FOR DRYING PURPOSES AND ANY NECESSARY CHECKS
- VELCRO® BRAND FASTENER STRAPS TO SECURE YOUR DIVING EQUIPMENT DURING TRANSPORTATION

**TECHNICAL FEATURES**

Dimensions (LxWxH)	Unit Net Weight	Volume
100 x 33 x 65cm / 39.4 x 13 x 25.6in	2.3kg / 5lb	140l / 8543in ³

CRUISE DRY ATTACK TITAN

Code: 415524

- HEAT SEALED BAG WITHOUT STITCHING
- 500D TARPULIN, STURDY AND LIGHTWEIGHT
- FOLDABLE WITH A LARGE INTERNAL VOLUME
- ADJUSTABLE HANDLES
- SIDE DRAIN VALVE

**TECHNICAL FEATURES**

Dimensions (LxWxH)	Unit Net Weight	Volume
90 x 46 x 35cm / 35.4 x 18.1 x 13.7in	1.7kg / 3.7lb	144L / 8787in ³

CRUISE DRY D55

Code: 415451

- DRY 55L DUFFLE BAG
- DOUBLE CLOSURE SYSTEM
- LARGE INTERNAL VOLUME
- HAND STRAP & ADJUSTABLE SHOULDER STRAP
- STURDY 500D TARPULIN
- IDEAL FOR WATERSPORTS AND OUTDOOR ACTIVITIES
- SVHC FREE MATERIAL

**TECHNICAL FEATURES**

Dimensions (LxWxH)	Unit Net Weight	Volume
60 x 30 x 55cm / 23.5 x 12 x 21.5in	0.9kg / 2lb	55l / 3356in ³

CRUISE DRY MBP15

Code: 415450

- MODULAR 15L BACKPACK
- ROLL NECK & BUCKLE CLOSURE SYSTEM
- ADJUSTABLE, PRE-SHAPED SHOULDER STRAPS
- PADDED BACKPACK
- ADJUSTABLE CHEST AND WAIST STRAPS
- REMOVABLE LAPTOP AND GADGET SLEEVE
- REMOVABLE MESH POCKET
- STURDY 500D TARPULIN
- IDEAL FOR WATERSPORTS AND OUTDOOR ACTIVITIES
- SVHC FREE MATERIAL

**TECHNICAL FEATURES**

Dimensions (LxWxH)	Unit Net Weight	Volume
40 x 12 x 65cm / 16 x 5 x 25.5in	1.2kg / 2.6lb	15l / 915in ³

CRUISE DRY T**T35**

Code: 415452

T25

Code: 415453

T10

Code: 415454

T5

Code: 415455

- DRY BAG TUBULAR AVAILABLE IN FOUR SIZES AND COLORS
- COLOR & SIZE SYSTEM
- ADJUSTABLE SHOULDER STRAP
- QUICK CLOSURE SYSTEM
- STURDY 500D TARPULIN
- IDEAL FOR WATERSPORTS AND OUTDOOR ACTIVITIES
- SVHC FREE MATERIAL



CRUISE DRY BP75 - ULTRALIGHTCode: **415460**

- ROLLING CLOSURE SYSTEM
- ADJUSTABLE, PADDED SHOULDER STRAPS
- ADJUSTABLE WAIST STRAPS
- STURDY, LIGHTWEIGHT 210D POLYESTER
- FRONT POCKET WITH WATERPROOF ZIPPER
- IDEAL FOR WATER SPORTS AND OUTDOOR ACTIVITIES
- SVHC FREE MATERIALS

**TECHNICAL FEATURES**

Dimensions (LxWxH)	Unit Net Weight	Volume
41 x 22.5 x 83cm / 16.1 x 8.8 x 32.6in	0.40kg / 0.89lb	75l / 4577in ³

CRUISE DRY BP18 - LIGHTCode: **415480**

- IDEAL FOR WATERSPORTS AND OUTDOOR ACTIVITIES
- STYLISH DESIGN, AVAILABLE IN TWO COLORS
- AIR CROSSOVER SYSTEM: BETTER AIR CIRCULATION IN THE BACK AREA
- ROLLING CLOSURE SYSTEM
- STURDY AND LIGHTWEIGHT
- FRONT POCKET WITH DRY ZIP
- ADJUSTABLE, PRE-SHAPED, COLORED SHOULDER STRAPS
- ADJUSTABLE CHEST STRAPS



DISCOVER MORE



AQ

BL

TECHNICAL FEATURES

Dimensions (LxWxH)	Unit Net Weight	Volume
23cm x 60cm / 9in x 23.6in	0.40kg / 0.89lb	18l / 1098in ³

CRUISE DRY ULTRALIGHT**T25 - ULTRALIGHT**Code: **415461****T10 - ULTRALIGHT**Code: **415462****T5 - ULTRALIGHT**Code: **415463**

- REINFORCED, LIGHTWEIGHT POLYESTER
- QUICK CLOSURE SYSTEM
- HEAT-SEALED STITCHING
- FULLY WATERPROOF
- EXCELLENT FOR WATER SPORTS
- IDEAL FOR OUTDOOR ACTIVITIES
- AVAILABLE IN THREE DIFFERENT SIZES
- SVHC FREE MATERIALS

**CRUISE CARPET**Code: **415478**

- DOUBLE USE BAG
- DRY CARPET FOR DONNING AND DOFFING DIVE GEAR
- QUICK AND EASY TO FOLD
- DRAWSTRING CLOSURE
- EXTREMELY LIGHTWEIGHT

**TECHNICAL FEATURES**

Dimension (D)	Unit Net Weight	Volume
140cm / 55in	0.8kg / 1.7lb	75l / 4577in ³

CRUISE REGCode: **415471**

- ADJUSTABLE SHOULDER STRAP
- INTERNAL ZIPPERED MESH POCKET
- VELCRO® BRAND FASTENERS TO ATTACH REGULATORS
- BUSINESS CARD POCKET
- COLORED, MICRO-INJECTED ZIPPER PULLERS W/MARES LOGO

**TECHNICAL FEATURES**

Dimensions (LxWxH)	Unit Net Weight	Volume
26x10x36 cm / 10"x4"x14"	0,25 kg / 0.55 lb	9.4 l / 573 cu.in.

CRUISE MESHCode: **415576**

- FULL MESH
- TO STORE SCUBA DIVING OR FREE DIVING EQUIPMENT
- CAN BE FOLDED INTO A ROUND BAG WITH HANDLE

**MESH BAG**Code: **415515**

- PRACTICAL AND COMPACT MESH SACK
- EASY TO CARRY AND FOR RINSING EQUIPMENT
- IDEAL FOR SNORKELING

**CRUISE DIVER**Code: **415475**

- ADJUSTABLE SHOULDER STRAP
- DEDICATED POCKET FOR COMPUTER AND INTERFACE
- MOBILE PHONE POCKET
- MANY PLACES FOR ELECTRONIC DEVICES
- KEY HOLDER
- CARD HOLDER



BAGS



Bag	Cruise Backpack Pro	Cruise Backpack	Cruise Backpack Roller	Cruise Buddy	Cruise Captain	Cruise Backpack Mesh Deluxe	Cruise Backpack Mesh Elite	Cruise X-Strap
Code	415464	415465	415466	415467	415472	415476	415477	415469
Dimensions (LxWxH)	47 x 32 x 81cm 18.5 x 12.5 x 32in	40 x 31 x 80cm 16 x 12 x 31.5in	47 x 32 x 81cm 18.5 x 12.5 x 32in	43 x 27 x 75cm 17 x 10.5 x 29.5in	36 x 22 x 55cm 14 x 8.5 x 22in	41 x 41 x 75cm 16 x 16 x 29.5in	39 x 39 x 74cm 15.5 x 15.5 x 29in	76 x 31 x 33cm 30 x 12 x 13in
Unit Net Weight	5kg / 11lb	4.4kg / 9.7lb	3kg / 6.6lb	3.5kg / 7.7lb	2.8kg / 6.2lb	1.2kg / 2.6lb	0.5kg / 1.1lb	1.2kg / 2.6lb
Volume	128l / 781in ³	100l / 607in ³	128l / 781in ³	87l / 530in ³	42l / 256in ³	123.5l / 753in ³	114l / 695in ³	76l / 463in ³
A.T.O. Air Travel Optimized	■	■	■	■	■			■
Heavy Duty Wheels			■	■	■			
Backpack System	■	■	■			■	■	■
Foldable System			■				■	



Bag	Cruise Classic	Cruise Pool	Cruise Journey	Cruise Beach	Cruise Carpet	Cruise Reg	Cruise Mesh
Code	415473	415468	415470	415506	415478	415471	415576
Dimensions (LxWxH)	76 x 29 x 36cm 30 x 11.5 x 14in	69 x 26 x 29cm 27 x 10 x 11in	31 x 20 x 56cm 12.2 x 8 x 22in	73 x 27 x 17cm 28.7 x 10.6 x 6.7in	140cm* 55in	26 x 10 x 36cm 10 x 4 x 14in	95.3 x 38.1 x 38.1cm 37.5 x 15 x 15in
Unit Net Weight	2kg / 4.4lb	0.7kg / 1.5lb	1.2kg / 2.6lb	0.43kg / 0.95lb	0.8kg / 1.7lb	0.25kg / 0.55lb	0.67kg / 1.48lb
Volume	79l / 482in ³	50l / 305in ³	35l / 213in ³	31l / 189in ³	75l / 457in ³	9.4l / 573in ³	108.5l / 6623in ³
A.T.O. Air Travel Optimized	■	■	■				
Backpack System			■				
Foldable System					■		■

DRY BAGS



Dry Bag	Cruise Dry Attack Titan	Cruise Dry Roller	Cruise Dry D55	Cruise Dry MBP15	BP18 Light	BP75 Ultralight
Code	415524	415485	415451	415450	415480	415460
Density	500 D Polyurethane	500 D Polyurethane	500 D Polyurethane	500 D Polyurethane	Body: 210 D Polyurethane, Bottom: 420 D Polyurethane	210 D Polyurethane
Dimension (DxH)	90 x 46 x 35cm 35.4 x 18.1 x 13.7in	100x33x65 cm 39.4 x 13 x 25.6 in	60 x 30 x 55cm 23.5 x 12 x 21.5in	40 x 12 x 65cm / 16 x 5 x 25.5in	23cm x 60cm 9in x 23.6in	41 x 22.5 x 83cm 16.1 x 8.8 x 32.6in
Unit Net Weight	1.7kg / 3.7lb	2.3 kg / 5lb	0.9kg / 2lb	1.2kg / 2.6lb	0.40kg / 0.89lb	0.40kg / 0.89lb
Volume	144L / 878in ³	140L / 8543in ³	55L / 335in ³	15L / 915in ³	18l / 1098in ³	75l / 4577in ³



Dry Bag	T5	T10	T25	T35	T5 Ultralight	T10 Ultralight	T25 Ultralight
Code	415455	415454	415453	415452	415463	415462	415461
Density	500 D Polyurethane	500 D Polyurethane	500 D Polyurethane	500 D Polyurethane	210 D/PU	210 D/PU	210 D/PU
Dimension (DxH)	16.5cm x 29cm 6.5in x 11.4in	19.5cm x 33.5cm 7.7in x 13.2in	25.5cm x 56.5cm 10in x 22.2in	25.5cm x 69cm 10in x 27.2in	15cm x 48cm 5.9in x 18.9in	20cm x 35cm 7.8in x 13.7in	24cm x 57.5cm 9.4in x 22.6in
Unit Net Weight	0.14kg / 0.31lb	0.17kg / 0.38lb	0.35kg / 0.77lb	0.40kg / 0.89lb	0.05kg / 0.11lb	0.06kg / 0.13lb	0.11kg / 0.24lb
Volume	5l / 305in ³	10l / 610in ³	25l / 1525in ³	35l / 2136in ³	5l / 305in ³	10l / 610in ³	25l / 1525in ³

* Diameter



**DIVE KNIFE
MAXIMUS**

Our multipurpose diver's knives are available in 2 sizes: 230mm and 137mm.

Blades and handles are made in Stainless Steel 440 (W1.14116) with a PVD coating to prevent corrosion in the marine environment.

Blade thickness is 4mm, and both models feature a blade with a blunt tip, a screwdriver, a razor blade, a serrated edge blade, a bottle opener and a line cutter, but that isn't all!

Both knives come with a robust Cordura sheath with attachment loops for a belt and straps for arm or ankle attachment.

**DIVE KNIFE
NEUTRON**

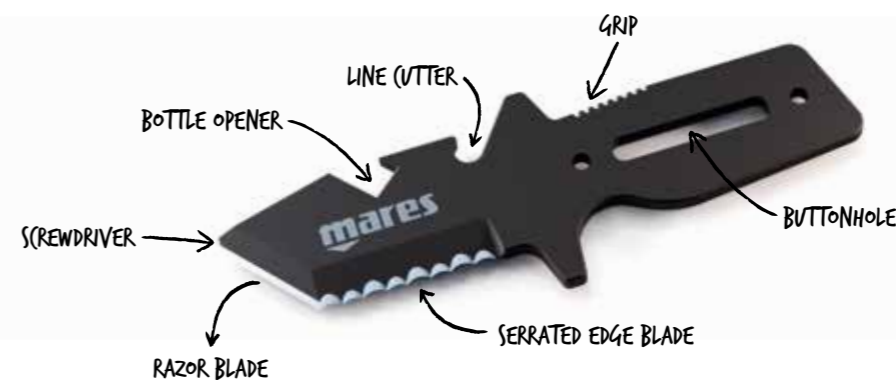

MAXIMUS**NEW**Code: **415604**

- MULTIPURPOSE DIVER'S KNIFE
- BLADE AND HANDLE IN STAINLESS STEEL 440 (W1.14116) WITH A PVD COATING TO PREVENT CORROSION IN THE WATER
- 55/56 HRC
- 4MM BLADE THICKNESS
- 230MM TOTAL LENGTH
- FEATURES A BLUNT TIP, SCREWDRIVERS, A RAZOR BLADE, A SERRATED EDGE BLADE, A BOTTLE OPENER AND A LINE CUTTER
- ROBUST CORDURA SHEATH WITH STRAPS FOR ARM OR ANKLE ATTACHMENT

**NEUTRON****NEW**Code: **415605**

- MULTIPURPOSE DIVER'S KNIFE
- BLADE AND HANDLE IN STAINLESS STEEL 440 (W1.14116) WITH A PVD COATING TO PREVENT CORROSION IN THE WATER
- 55/56 HRC
- 4MM BLADE THICKNESS
- 137MM TOTAL LENGTH
- FEATURES A BLUNT TIP, SCREWDRIVERS, A RAZOR BLADE, A SERRATED EDGE BLADE, A BOTTLE OPENER AND A LINE CUTTER
- ROBUST CORDURA SHEATH WITH STRAPS FOR ARM OR ANKLE ATTACHMENT

**SMARTY MINI MULTITOOL****NEW**Code: **415808**

- EXCLUSIVE MARES DESIGNED MINI MULTITOOL
- THE PERFECT COMPACT TOOL FOR BASIC OPERATIONS
- TOTAL LENGTH: 95MM
- STRUCTURE: STAINLESS STEEL 440 (W1.14116) WITH A PVD COATING
- 55/56 HRC
- 4MM THICKNESS
- BOTTLE OPENER
- 4MM ALLEN KEY
- SCREWDRIVER
- 4-6-8-13-14 MM SPANNERS
- INCLUDES AN ATTACHMENT LOOP

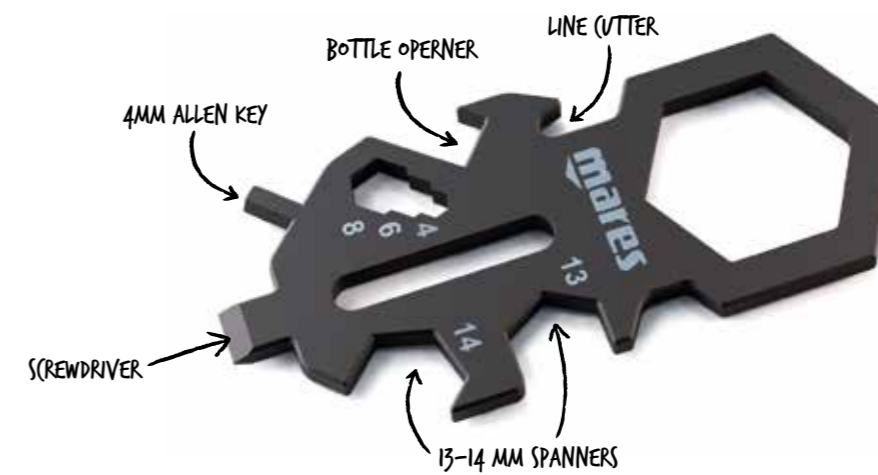
**SMARTY**
MINI MULTITOOL

An exclusive Mares-designed Mini Multitool: the perfect compact for basic operations, with a total length of 95mm. Made in Stainless Steel 420 with a PVD coating.

The multitool's main features are:

- BOTTLE OPENER
- 4MM ALLEN KEY
- SCREWDRIVER
- 4-6-8-13-14 MM SPANNERS
- AN ATTACHMENT LOOP

**DON'T BE WITHOUT YOUR SMARTY MINI MULTITOOL.
THE VERSATILE ADDITION TO YOUR DIVING EQUIPMENT!**

TITANIUM/CERAMIC LINE CUTTER

NEW

Code: 415615

- TITANIUM / CERAMIC BLADE
- EXCELLENT ABRASION AND CORROSION RESISTANCE
- VELCRO® BRAND FASTENER
- DEDICATED CORDURA SHEATH: AVAILABLE IN 5 COLOR VERSIONS



FORCE PLUS

Code: 415626

- SOFT OVERMOLDED ERGONOMIC HANDLE
- FITS ON MARES BCDS, BAGS AND HOSES
- EASY RELEASE SYSTEM, EVEN WITH GLOVES



TECHNICAL FEATURES

Blade	Stainless Steel - PVD Coated
Blade length	100mm / 3.9in

FORCE NANO PLUS

Code: 415627

- SOFT OVERMOLDED ERGONOMIC HANDLE
- FITS ON MARES BCDS, BAGS AND HOSES
- EASY RELEASE SYSTEM, EVEN WITH GLOVES



TECHNICAL FEATURES

Blade	Stainless Steel - PVD Coated
Blade length	65mm / 2.6in

TITANIUM/CERAMIC LINE CUTTER

The Mares Line Cutter is the versatile cutting tool that every diver should carry, with one titanium blade and one ceramic blade, offering excellent abrasion and corrosion resistance.

The line cutter fits securely into a nylon pouch equipped with two bands, allowing it to be mounted horizontally or vertically. These pouches are available in five different colors (blue, silver, white, red or aqua) to perfectly match your Mares diving equipment.



**CHOOSE YOUR FAVORITE COLOR
AND ADD EXTRA SAFETY TO YOUR DIVE GEAR!**

STANDARD MARKER

Code: 415709

- HIGHLY VISIBLE EGG SHAPE
- ONE PIECE CONSTRUCTION WITH INTEGRATED FLAG
- TWO-CHAMBER CONSTRUCTION FOR SAFETY AND AN UPRIGHT POSITION
- 20 M ROPE
- VARIOUS HOOKS



TORPEDO

Code: 415721

- LOW-DRAG TORPEDO SHAPE FOR EASY TOWING
- HIGH VISIBILITY ORANGE COLOR
- TWO-CHAMBER CONSTRUCTION FOR SAFETY AND AN UPRIGHT POSITION
- 20M ROPE
- SIX UNIVERSAL ADJUSTMENT CONNECTORS



COMPACT REEL

Code: 415349

- FOLDABLE HANDLES
- DOUBLE ENDED CARABINER
- 30M / 100 FT LINE



COMPACT

Code: 415742

- ORANGE DIVER MARKER BUOY
- 10M LINE
- 300G -2/3 LB SHAPED LEAD WEIGHT
- NYLON SACK WITH CARABINER



STANDARD INFLATABLE

Code: 415707

- HIGH VISIBILITY ORANGE COLOR
- FOLDING BAG WITH HOOK
- 20M ROPE AND VARIOUS HOOKS
- INTEGRATED WEIGHTS FOR PROPER SURFACE FLOTATION
- FITS IN BCD POCKET



DIVER MARKER BUOY - ALL IN ONE

Code: 415753

- 180CM HEIGHT
- 5CM / 2" SOLAS REFLECTIVE TAPE
- EXTREMELY LIGHTWEIGHT
- "DIVER BELOW" REFLECTIVE WRITING
- INTEGRATED MESH POCKET FOR SPOOL
- 20M / 66FT SPOOL INCLUDED
- STAINLESS STEEL D-RING
- DOUBLE ENDER STAINLESS STEEL CARABINER
- ORAL INFLATE CONNECTOR FOR LP BCD HOSE
- OVER PRESSURE RELEASE VALVE
- VELCRO® BRAND CLOSURE



DIVER'S ALERT MARKER

Code: 415743

- 180CM TALL AND 15CM WIDE FOR HIGH VISIBILITY
- SOLAR REFLECTIVE TAPE
- AUTOMATIC SEAL SYSTEM
- ORAL INFLATION CONNECTOR FOR LP BCD HOSE
- PRESSURE RELEASE VALVE
- DEDICATED POCKET FOR LIGHT
- STAINLESS STEEL DRING



SILICONE GREASECode: **415102**

- IDEAL FOR MAINTENANCE AND TO LUBRICATE O-RINGS
- MADE IN COMPLIANCE WITH LATEST REGULATIONS
- 20 ML

**SCUBA CLEAN**Code: **415905 Desk Exhibitor (12pcs)**

- MARES SANITIZER FOR ALL SCUBA GEAR
- TRIPLE ACTION: FUNGICIDE, BACTERICIDE AND VIRUCIDE
- OFFERS TOTAL DISINFECTION, CLEANLINESS AND SANITIZATION
- COMPATIBLE WITH PLASTIC, NYLON, NEOPRENE AND METAL
- 125ML

**UNIVERSAL HANGER**Code: **415177**

- HOLDS UP TO 15 DIFFERENT ITEMS
- UNIQUE MARES DESIGN
- STURDY AND ROBUST
- EQUIPMENT PERFECTLY ORGANIZED

**DRYSUIT HANGER**Code: **415713**

- PERFECT FOR DRY SUITS WITH BOOTS
- BETTER VENTILATION BECAUSE THE DRY SUIT IS UPSIDE DOWN
- STURDY AND SIMPLE TO USE

**WEIGHT BELT**Code: **415122**

- QUICK RELEASE PLASTIC BUCKLE

**STAINLESS STEEL BELT**Code: **415123**

- QUICK RELEASE STAINLESS STEEL BUCKLE

**SHELL REGULATOR**Code: **415866**

- PERFECT SIZE FOR STORING REGULATORS
- DEDICATED HANDLE FOR EASY CARRYING
- SHOCKPROOF CASE
- STURDY ZIPPER
- MARES MICRO-INJECTED LABEL
- SILVER PIPING

**SHELL OVAL**Code: **415864**

- SHOCKPROOF CASE
- STURDY ZIPPER
- MARES MICRO-INJECTED LABEL
- SILVER PIPING
- PERFECT FOR TORCHES, MASKS AND MORE

**SHELL ROUND**Code: **415865**

- SHOCKPROOF CASE
- STURDY ZIPPER
- MARES MICRO-INJECTED LABEL
- SILVER PIPING
- IDEAL FOR DIVE COMPUTERS

**MAGNETIC SHAKER**Code: **415172**

- SPECIAL MAGNETIC SYSTEM
- TO PREVENT UNWANTED AND IRRITATING NOISE
- LIGHTWEIGHT AND EASY TO STORE
- EASY TO USE WITH JUST A SIMPLE DOWNWARD MOVEMENT

**DIVING BOX**Code: **415516 (4 pcs)**

- TO STORE, PROTECT AND CARRY DIVING EQUIPMENT
- SIZES: 82X42X38CM
- 130L CAPACITY
- REMOVABLE HANDLE
- RELIABLE WHEELS
- STURDY MATERIAL

**PERSONAL DRY BOX**Code: **415727**

- LANYARD FOR TRANSPORTATION
- DRY SEAL FOR WATERTIGHT CLOSURE
- SLEEK DESIGN
- SMALL AND DURABLE

**AIR NOZZLE**Code: **415724**

- EASY TO USE
- QUICK CONNECTION AND DISCONNECTION FROM LP INFLATOR HOSE
- USE AIR TO CLEAN AND DRY
- NOT ONLY FOR SCUBA EQUIPMENT

**UNDERWATER SLATE**Code: **415719**

- BRIGHT WHITE WRITING SLATE
- COMPACT SIZE: 12 X 15CM
- HOOK SYSTEM TO ATTACH TO YOUR BCD
- QUICK RELEASE BUCKLE
- STANDARD REPLACEABLE PENCIL WITH SILICONE TUBE



TANKS

Code: **415188 10L single valve**

Code: **415189 12L single valve**

Code: **415190 15L double valve**

- SINGLE PIECE CONSTRUCTION IN STEEL ALLOY
- 3 SIZES : 10L, 12L AND 15L
- MEETS REQUIREMENTS OF DIRECTIVE 2014/68EU
- INT/DIN VALVE CONNECTION
- RUBBER BOOT
- OPTIONAL SECOND CONNECTION FOR 10L AND 12L SINGLE VALVE



TANKS NETS

Code: **415749 10L YL**

Code: **415731 12L BL**

Code: **415730 15L BK**

- HIGH QUALITY NYLON
- VARIOUS COLORS & SIZES
- 10L/YELLOW, 12L/BLUE AND 15L/BLACK



Code	415188	415189	415190
Volume	10 liters	12 liters	15 liters
Valve	Single		Double
Weight	13.5kg / 29.6lb	16.5kg / 36.5lb	20kg / 44.1lb
Height	67cm / 26.4in	61cm / 24.0in	71cm / 28in
Diameter	18cm / 7.0in	22cm / 8.6in	
Operating pressures	232 bar		
Material	Heat-treated steel		
Internal coating	Phosphate coating and anti-corrosion treatment		
Black external coating	Soft touch polyurethane coating		

VALVE 2ND CONNECTION*

Code: **45200439**

- INT/DIN VALVE CONNECTION LEFT
- OPTIONAL FOR 10 AND 12 LITER TANK VALVES



DIVER TOOL KIT

Code: **415726**

- IDEAL FOR TROUBLE-SHOOTING ON DIVING EQUIPMENT
- 20 TOOLS INCLUDING SPANNERS, SCREWDRIVERS, PLIERS, ALLEN KEYS AND MORE
- HANDY SIZE ZIPPERED CASE
- EASY STORAGE



MULTI TOOLS

Code: **415701 Multi Tools Pro**

Code: **415703 Multi Tools Tech**

- TWO VERSIONS FOR ALL NEEDS
- TECH: VARIOUS SPANNERS AND SCREWDRIVERS
- PRO: VARIOUS SPANNERS AND ALLEN WRENCHES
- HIGH QUALITY STAINLESS STEEL WITH NICKEL COATING
- EASY TO USE
- EXCLUSIVE MARES DESIGN
- OVERMOLDED HANDLE WITH MARES LOGO



* Assembly, checks and any necessary adjustments must be done by a Mares lab Authorized Service Center



JUNIOR LINE



ROVER 15X

Code: 416254 INT / DIN 300



2ND STAGE

- EASY-TO-USE PURGE BUTTON WITH DYNAMIC HINGE DESIGN
- VAD SYSTEM WITH FLUID DYNAMIC DEFLECTOR
- MID-SIZE
- OVERSIZED PURGE BUTTON
- RUBBER HOSE

1ST STAGE

- DFC PORT
- PRE-ORIENTED PORTS
- COMPACT SIZE
- SANDBLASTED FINISH



TECHNICAL FEATURES

	INT	DIN 300 bar
1st Stage		
Type	INT	DIN 300 bar
Weight	772g / 27.2oz	598g / 21.1oz
High pressure ports	2 HP 7/16" UNF Ports	
Low pressure ports	4 LP 3/8" UNF Ports	
2nd Stage		
Weight	190g / 6.7oz	
Material/Finish	Ultralight Technopolymer	
LP Hose Type/Length	Rubber hose / 80cm	
Total weight (including hose)	1107g / 39oz	933g / 32.9oz

ACCESSORIES

Accessories	Code	Page
15X	416237	Page 27
Octopus Rover	416557	Page 155
DIN Connector	416809	Page 31

ROVER 2S

Code: 416255 INT / DIN 300



2ND STAGE

- EASY-TO-USE PURGE BUTTON WITH DYNAMIC HINGE DESIGN
- VAD SYSTEM WITH FLUID DYNAMIC DEFLECTOR
- MID-SIZE
- OVERSIZED PURGE BUTTON
- RUBBER HOSE

1ST STAGE*

- LIGHTWEIGHT, STURDY AND COMPACT
- PISTON CONTROL
- DEDICATED PLACE FOR RFID CHIP



TECHNICAL FEATURES

	INT	DIN 300 bar
1st Stage		
Type	INT	DIN 300 bar
Weight	608g / 21.4oz	432g / 15.2oz
High pressure ports	1 HP 7/16" UNF Port	
Low pressure ports	4 LP 3/8" UNF Ports	
2nd Stage		
Weight	190g / 6.7oz	
Material/Finish	Ultralight Technopolymer	
LP Hose Type/Length	Rubber hose / 80cm	
Total weight (including hose)	977g / 34.5oz	978g / 34.5oz

ACCESSORIES

Accessories	Code	Page
2S	416232	Page 27
Octopus Rover	416557	Page 155
DIN Connector	416809	Page 31

OCTOPUS ROVER

Code: 416557



2ND STAGE

- EASY-TO-USE PURGE BUTTON WITH DYNAMIC HINGE DESIGN
- VAD SYSTEM WITH FLUID DYNAMIC DEFLECTOR
- MID-SIZE
- OVERSIZED PURGE BUTTON
- RUBBER HOSE



TECHNICAL FEATURES

Weight	190g / 6.7oz
Material / Technology	Ultralight Technopolymer
LP Hose Type /Length	Rubber hose/ 100cm
Total weight (including hose)	365g /12.8 oz



*Picture not to scale

PUCK PRO +

Code: 414135

- SLIM DESIGN FOR A PERFECT FIT
- INTUITIVE USER INTERFACE WITH ONE-BUTTON SIMPLICITY
- LOGBOOK CAPACITY 35 HOURS OF DIVE PROFILE AT 5-SECOND SAMPLING RATE
- UPGRADEABLE FIRMWARE
- BOTTOM TIMER MODE WITH RESETTABLE AVERAGE DEPTH AND STOPWATCH
- USER-REPLACEABLE BATTERY
- DOES NOT INCLUDE INTERFACE AND SOFTWARE FOR DOWNLOADING TO PC



EXPLORER

Code: 417229

- KID/JUNIOR BCD WITH A DEDICATED BACKPACK
- 2 COMFORTABLE POCKETS WITH VELCRO® BRAND CLOSURE
- SPECIALLY DESIGNED OCTOPUS AND PRESSURE GAUGE POCKETS
- OPTIONAL TRIM WEIGHTS TO BE PLACED ON TANK STRAP
- TANK BAND: DEDICATED ADAPTABLE SHORTER TANK BAND TO FIT SMALLER TANKS
- 1 SIZE FITS ALL, FROM 8 - 12 YEARS, THANKS TO A DEDICATED ADJUSTMENT SYSTEM



MARES EXPLORER JUNIOR LINE

Mares has dedicated a full range of products to junior divers. Junior divers deserve special attention in product development, and we feel proud to offer them the best equipment with our Mares Explorer Junior Line.

Safety first, through proven superior technology, together with comfort and our unique stylish design are the main ingredients of each and every Mares product.

Have fun and ... Just Add Water!

TECHNICAL FEATURES

Battery	Type	CR2450
	Duration	200-300 dives
Nitrox		EAN from 21% to 99%

ACCESSORIES

Dive Link 2 USB	414316	Page 46
Bluelink Pro	414317	Page 46

MISSION 1

Code: 414417

- BRASS CASE
- TECHNO-POLYMER WINDOW
- PHOSPHORESCENT DIAL FACE
- PROTECTIVE RUBBER CONSOLE
- MULTIPLE ATTACHMENT POINTS



TECHNICAL FEATURES

Explorer	3XS
Weight	1.8kg / 3.9lb
Buoyancy	70N (7.8kg / 17lb)

ACCESSORIES

Trim Weight	417964	Page 60
Weight Pocket Explorer	417965	Page 156

WEIGHT POCKET EXPLORER

Code: 417965 - PAIR

- EXPANDS THE CAPABILITY OF THE EXPLORER BC
- RELEASEABLE WEIGHT POCKETS FIT INTO CARGO POCKETS FOR EASY ACCESS
- CAPACITY 1 KG / 2LBS



Scuba Ranger Suits



Comet Mask

Pluto Snorkel



Explorer BCD



Puck Pro +



Avanti X3 Fin

SCUBA RANGER

Code: **412373 Jacket**

Code: **412374 Long John**

- DEDICATED KID'S TWIN SUIT: LONG-SLEEVED, HOODED JACKET AND LONG JOHN (SOLD SEPARATELY)
- JACKET AND LONG JOHN CAN BE WORN TOGETHER OR SEPARATELY ACCORDING TO WATER TEMPERATURE
- DEDICATED DESIGN AND COLOR FOR KIDS: SHOULDERS AND ZIPPERS IN LIME
- VARIED THICKNESSES STRATEGICALLY PLACED IN DIFFERENT AREAS OF THE BODY FOR COMFORT AND FREEDOM OF MOVEMENT
- EASY DONNING AND DOFFING



TECHNICAL FEATURES

Thickness	5mm			
Fabric Type	Neoprene			
Sizes	-3	-2	-1	0
Ages*	8Y	10Y	12Y	14Y

CLASSIC NG 5MM

Code: **412634**

- EASY DONNING AND DOFFING
- LIGHTWEIGHT - IDEAL FOR TRAVELLING
- ANTI-SLIP SOLE



TECHNICAL FEATURES

Thickness	5 mm												
Sizes	3	4	5	6	7	8	9	10	11	12	13		

*Ages indicated in the table are purely for reference

RASH GUARD JUNIOR

SHORT SLEEVE

Code: **412506 Boy**

Code: **412507 Girl**

- LIGHTWEIGHT AND COOL MATERIAL
- UPF+50 PROTECTION
- QUICK DRYING
- ULTRA COMFORTABLE FLAT SEAMS
- DEDICATED CUT FOR CHILDREN



UPF 50+

TECHNICAL FEATURES

Thickness	-				
Fabric Type	Polyester / Spandex				
Sizes	XS	S	M	L	XL
Ages*	8/9	9/10	10/11	11/12	12/13



COMET

Code: 411059

- MONOLENS MASK FOR CHILDREN
- SILICONE SKIRT
- AMPLE FIELD OF VISION
- LIGHTWEIGHT
- STRAP WITH QUICK-RELEASE BUCKLES



COLOR VARIATIONS



PLUTO

Code: 411486

- 100% DRY TOP SNORKEL DEDICATED TO JUNIORS
- SLIDING SNORKEL KEEPER
- SILICONE MOUTHPIECE
- EXHAUST VALVE
- WHISTLE ON BOTTOM AS SAFETY DEVICE



COLOR VARIATIONS



PLANA AVANTI X3

Code: 410001

- ABS PLUS BUCKLE FOR ONE HAND ADJUSTMENT
- 3 CHANNELS FOR MAXIMUM THRUST
- STABILIZING TRIM TABS
- MID-SIZE BLADE WITH DURABLE CONSTRUCTION



TECHNICAL FEATURES

Sizes	XS		
Blade	33 cm / 13.0 in		
BUOYANCY	NEGATIVE	NEUTRAL	POSITIVE
FITTING	REGULAR		WIDE
WEIGHT (Size R or 42)	0.5 KG		1.0 KG
MANEUVERABILITY	MEDIUM		HIGH
THRUST/ USE AGAINST CURRENT	LOW PERFORMANCE		HIGH PERFORMANCE
KICKING	FROG	BOTH	FLUTTER



2023

mares | **XR**
extended range

EXTENDED RANGE





BREATHING SYSTEMS



PRODUCT SELECTOR



	28XR-HR TEK SET	28XR-HR	25XR-DR TEK SET	HR	2 nd STAGE			1 st STAGE		
					DR	VR	28XR	25XR	2XR	
Code	416409	416410	416415	416412	416416	416408	416411	416414	416407	
Page	164	165	166	167	167	168	168	169	169	
Kind of dive & type of use	Sidemount use	•		•	•		•			
	EN 13949 Nitrox		•	•	•	•	•		•	
	Deep dive (tested to 200m)	•	•	•	•		•	•		
	Cold water	•	•	•	•	•	•	•	•	
	Extreme cold water	•	•	•	•	•	•	•		
	Travel optimized				•		•			
1st Stage Details	Dynamic flow control	•	•	•			•	•		
	Dry system (AST)	•	•	•			•	•	•	
	Twin balanced piston	•	•	•			•	•		
	360° Swivel turret	•	•				•			
	Finish	Chrome-Shiny	Chrome-Shiny	Chrome-Shiny			Chrome-Shiny	Chrome-Shiny	Sandblasted	
2nd Stage Details	VAD / Vortex Assisted Design	•	•	•	•	•	Sagittal			
	Adjustable breathing comfort	•	•		•					
	PAD / Pneumatically assisted	•	•		•					
	Left & right sided use						•			
	Material / Technology	Ultralight Technopolymer	Ultralight Technopolymer	All Metal	Ultralight Technopolymer	All Metal	Ultralight Technopolymer			

28XR - HR - FULL SM TEK SET

Code: 416409*



THIS SET INCLUDES:

- 2 X HR SECOND STAGES
- 2 X 28XR FIRST STAGES
- 2 X MIFLEX XT-TECH HOSES (60CM - 210CM)
- 2 X SHORT MIFLEX XT-TECH SIDEMOUNT INFLATOR HOSES (20 CM)
- 1M OF 4MM BUNGEE
- 2 X PRESSURE GAUGES

2ND STAGE

- FOR STAGE, SIDEMOUNT, MAIN BACKMOUNT, BACK-UP BACKMOUNT OR "HARD BREATHING" BACKMOUNT USE
- EXTREME COLD WATER USE
- ADJUSTABLE BREATHING COMFORT SYSTEM ALLOWS THE DIVER TO CONTROL INHALATION EFFORT
- SIMPLE, PERFORMING, ULTRALIGHT TECHNOLOGY
- PAD - PNEUMATICALLY ASSISTED DESIGN
- OVERSIZED PURGE BUTTON
- MIFLEX XT-TECH HOSE

1ST STAGE

- SHINY CHROME METAL BODY
- NATURAL DFC ON ALL LP PORTS
- TBP DRY KIT - ENVIRONMENTALLY SEALED FOR BETTER PERFORMANCE ON COLD WATER DIVES
- AST - AUTO SEALING TECHNOLOGY
- 4 LP PORTS ON A SWIVEL TURRET
- A 5TH ADDITIONAL IN-LINE LP PORT
- 2 SYMMETRICAL HP PORTS WITH A 10° PORT ANGLE FOR PERFECT HP HOSE POSITIONING
- G5/8 CONNECTION, 300BAR (DIN)



CERTIFIED PERFORMANCE at 200m
PROVEN TECHNOLOGY at 400m

RESULTS AND PERFORMANCE

Pressure - Volume diagram at mean depth of: 202.2 msw (663.2 fsw)

Inhale Pressure	10.93 Mbar
Inhale Positive Pressure	2.54 Mbar
Exhale Pressure	8.98 Mbar
Work Of Breathing	1.47 J/l
Inhale Work	0.78 J/l
Positive Inhale Work	0.00 J/l
Exhale Work	0.70 J/l

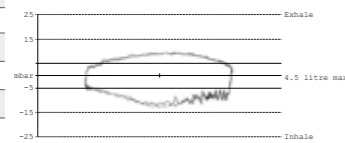

TECHNICAL FEATURES

	Type	DIN 300 bar
1 st Stage	Weight	827g / 29.2oz
	High pressure ports	2 [7/16" UNF]
	Low pressure ports	5 [3/8" UNF]
2 nd Stage	Weight	232g / 8.2oz
	Material/Finish	Ultralight Technopolymer
	LP Hose Type/Length	Miflex XT-Tech Hose / 60cm / 24in - 210cm / 7ft

*Meets and exceeds the requirements of NORSOK U-101 at a depth of 200m

28XR - HR

Code: 416410* - NR: black - G5/8

Code: 416410* - NX: green - M26



2ND STAGE

- FOR STAGE, SIDEMOUNT, MAIN BACKMOUNT, BACK-UP BACKMOUNT OR "HARD BREATHING" BACKMOUNT USE
- EXTREME COLD WATER USE
- ADJUSTABLE BREATHING COMFORT SYSTEM ALLOWS THE DIVER TO CONTROL INHALATION EFFORT
- SIMPLE, PERFORMING, ULTRALIGHT TECHNOLOGY
- PAD - PNEUMATICALLY ASSISTED DESIGN
- OVERSIZED PURGE BUTTON
- MIFLEX XT-TECH HOSE

1ST STAGE

- SHINY CHROME METAL BODY
- NATURAL DFC ON ALL LP PORTS
- TBP DRY KIT - ENVIRONMENTALLY SEALED FOR BETTER PERFORMANCE ON COLD WATER DIVES
- AST - AUTO SEALING TECHNOLOGY
- 4 LP PORTS ON A SWIVEL TURRET
- A 5TH ADDITIONAL IN-LINE LP PORT
- 2 SYMMETRICAL HP PORTS WITH A 10° PORT ANGLE FOR PERFECT HP HOSE POSITIONING



DISCOVER MORE



CERTIFIED PERFORMANCE at 200m
PROVEN TECHNOLOGY at 400m

RESULTS AND PERFORMANCE

Pressure - Volume diagram at mean depth of: 202.2 msw (663.2 fsw)

Inhale Pressure	10.93 Mbar
Inhale Positive Pressure	2.54 Mbar
Exhale Pressure	8.98 Mbar
Work Of Breathing	1.47 J/l
Inhale Work	0.78 J/l
Positive Inhale Work	0.00 J/l
Exhale Work	0.70 J/l

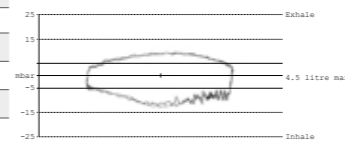

TECHNICAL FEATURES

	Type	DIN 300 bar	NITROX 200 bar
1 st Stage	Weight	827g / 29.2oz	805g / 28.4oz
	High pressure ports	2 [7/16" UNF]	
	Low pressure ports	5 [3/8" UNF]	
2 nd Stage	Weight	232g / 8.2oz	
	Material / Technology	Ultralight Technopolymer	
	LP Hose Type/Length	Miflex XT-Tech Hose / 75cm / 30in	

*Meets and exceeds the requirements of NORSOK U-101 at a depth of 200m

25XR - DR FULL TEK SET

Code: 416415*



THE 25XR FIRST STAGES ARE DESIGNED SPECIFICALLY FOR USE ON A TWINSET. THE PORTS ARE ORIENTED SO THAT ALL HOSES WILL ROUTE DOWNWARDS, PROVIDING THE STREAMLINED CONFIGURATION REQUIRED BY TECHNICAL DIVERS. ALLOWS UNRESTRICTED ACCESSIBILITY TO THE CYLINDER VALVES WHEN USING A TWIN CYLINDER SET UP.

THIS SET INCLUDES:

- 2 X DR SECOND STAGES
- 2 X 25XR FIRST STAGES
- 2 X HOSES (60CM - 210CM)
- 1 X NECK REGULATOR BUNGEE
- 1 X DEAD BOLT SNAP

2ND STAGE

- HIGH-PERFORMANCE SECOND STAGE
- EXTREME COLD WATER USE
- VAD SYSTEM - STABLE FLOW WITHOUT EXCESSIVE POSITIVE-PRESSURE BREATHING
- MESH GRID SYSTEM - COVER DESIGN DISPERSES WATER FLOW AND REDUCES FREE FLOW
- ALL METAL TECHNOLOGY - COMPACT AND RUGGED ALL-METAL BODY MADE FROM HIGH-IMPACT CHROME AND NICKEL-PLATED BRASS
- NO USER ADJUSTMENT NEEDED
- RUBBER LP HOSE
 - STRONGER RESISTANCE TO CUTS, ABRASIONS, BURSTING AND UV
 - LESS FLOATING

1ST STAGE

- TBP DRY KIT - ENVIRONMENTALLY SEALED FOR BETTER PERFORMANCE ON COLD WATER DIVES
- AST - FIRST STAGE DRY SYSTEM TO AVOID WATER ENTERING
- DFC - DYNAMIC FLOW CONTROL
- G5/8 CONNECTION, 300BAR (DIN)



CERTIFIED PERFORMANCE at 200m
PROVEN TECHNOLOGY at 400m

RESULTS AND PERFORMANCE

Pressure - Volume diagram at mean depth of: 203.3 msw (666.9 fsw)

Inhale Pressure	10.05 Mbar
Inhale Positive Pressure	1.96 Mbar
Exhale Pressure	10.95 Mbar
Work Of Breathing	1.28 J/l
Inhale Work	0.56 J/l
Positive Inhale Work	0.00 J/l
Exhale Work	0.72 J/l

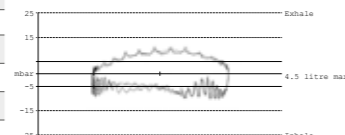

TECHNICAL FEATURES

1 st Stage	Type	DIN 300 bar
	Weight	777g / 27.4oz
	High pressure ports	1 (7/16" UNF)
	Low pressure ports	2 (3/8" UNF)
2 nd Stage	Weight	269g / 9.5oz
	Material/Finish	All Metal Technology
	LP Hose Type/Length	Rubber hose / 60cm / 24 inches - 210cm / 7ft

*Meets and exceeds the requirements of NORSOK U-101 at a depth of 200m

DR 2ND STAGE

Code: 416416* - NR: black - air

Code: 416416* - NX: green - O2



- HIGH-QUALITY, HIGH-PERFORMANCE SECOND STAGE, AVAILABLE ALSO FOR STAGE TANK CONFIGURATION
- EXTREME COLD WATER USE
- VAD SYSTEM - STABLE FLOW WITHOUT EXCESSIVE POSITIVE-PRESSURE BREATHING
- MESH GRID SYSTEM - COVER DESIGN DISPERSES WATER FLOW AND REDUCES FREE FLOW
- ALL METAL TECHNOLOGY - COMPACT AND RUGGED ALL-METAL BODY MADE FROM HIGH-IMPACT CHROME AND NICKEL-PLATED BRASS
- NO USER ADJUSTMENTS NEEDED
- RUBBER HOSE:
 - STRONGER RESISTANCE TO CUTS, ABRASIONS, BURSTING AND UV
 - LESS FLOATING
- CERTIFIED WITH THE 25XR FIRST STAGE



TECHNICAL FEATURES

Weight	269g / 9.5oz
Material	All Metal Technology
LP Hose Type/Length	Rubber hose / 110cm / 43in

*Spare parts to be used only in first/second stage combinations carrying a CE certification. The assembly, check and any necessary adjustments must be done by a Mares Lab Authorized Service Center.

HR 2ND STAGE

Code: 416412* - NR: black - air

Code: 416412* - NX: green - O2



- FOR STAGE, SIDEMOUNT, MAIN BACKMOUNT, BACK-UP BACKMOUNT OR "HARD BREATHING" BACKMOUNT USE
- COLD WATER USE
- ADJUSTABLE BREATHING COMFORT SYSTEM ALLOWS THE DIVER TO CONTROL INHALATION EFFORT
- SIMPLE, PERFORMING, ULTRALIGHT TECHNOLOGY BODY
- PAD - PNEUMATICALLY ASSISTED DESIGN
- OVERSIZED PURGE BUTTON
- MIFLEX XT-TECH HOSE
- CERTIFIED WITH THE 28XR FIRST STAGE



TECHNICAL FEATURES

Weight	232g / 8.2oz
Material	Ultralight Technopolymer
LP Hose Type/Length	Miflex XT-Tech Hose / 110cm / 43.3in

VR 2ND STAGE

Code: 416408* - NR: black - air
Code: 416408* - NX: green - O2



- THE FIRST VERTICAL SECOND STAGE EVER
- COLD WATER USE
- EXCELLENT BREATHING POSITION
- INTEGRATED SAGITTAL VAD (S-VAD)
- OVERSIZED SILICONE PURGE BUTTON
- FREEDOM OF MOVEMENT IN ALL POSITIONS
- IDEAL FOR STAGE DECOMPRESSION AND TRAVEL GAS
- CAN BE MOUNTED ON THE RIGHT AS WELL AS THE LEFT SIDE
- "UNDER THE SHOULDER" HOSE POSITION
- EASY TO PUSH PURGE BUTTON
- MIFLEX XT-TECH HOSE
- CERTIFIED WITH THE 2XR FIRST STAGE



TECHNICAL FEATURES

Weight	199g / 7oz
Material	Ultralight Technopolymer
LP Hose Type/Length	Miflex XT-Tech Hose / 110cm / 43in

28XR 1ST STAGE

Code: 416411* - NR: air - G5/8
Code: 416411* - NX: O2 - M26



THE 28XR IS A TECHNICAL FIRST STAGE IDEAL FOR:
- SIDEMOUNT REGULATORS
- BACKMOUNT REGULATORS
- STAGE REGULATORS

- SHINY CHROME METAL BODY
- EXTREME COLD WATER USE
- NATURAL DFC ON ALL LP PORTS
- TBP DRY KIT - ENVIRONMENTALLY SEALED FOR BETTER PERFORMANCE ON COLD WATER DIVES
- AST - AUTO SEALING TECHNOLOGY
 - KEEPS THE FIRST STAGE DRY. RELIABILITY WITHOUT COMPROMISE
 - THE SYSTEM IS AUTOMATICALLY ACTIVATED BY AIR
 - TESTED WITH OXYGEN IN COLD TEMPERATURES AND DEMANDING ENVIRONMENTS
 - PATENTED SYSTEM
- 4 LP PORTS ON A SWIVEL TURRET
- A 5TH ADDITIONAL IN-LINE LP PORT
- 2 SYMMETRICAL HP PORTS WITH A 10° PORT ANGLE FOR PERFECT HP HOSE POSITIONING
- CERTIFIED WITH THE VR SECOND STAGE



TECHNICAL FEATURES

Type	DIN 300 bar	NITROX 200 bar
Weight	760g / 27oz	805g / 28.4oz
High pressure ports	2 [7/16" UNF]	
Low pressure ports	5 [3/8" UNF]	

*Spare parts, to be used only in first/second stage combinations carrying a CE certification. The assembly, check and any necessary adjustments must be done by a Mares Lab Authorized Service Center.

25XR 1ST STAGE

Code: 416414* - Left
Code: 416414* - Right



- COMPACT, SOLID, ONE-PIECE BODY
- EXTREME COLD WATER USE
- 2 LP PORTS (3/8" UNF) ALL ANGLED DOWNWARDS
- 1 HP PORT (7/16" UNF) WITH IPD - INTERCHANGEABLE PORT DESIGN
- PERFECT, SNAG-FREE LP HOSE POSITIONING
- DFC - DYNAMIC FLOW CONTROL
- T.B.P. DRY KIT - ENVIRONMENTALLY SEALED FOR BETTER PERFORMANCE ON COLD WATER DIVES. PREVENTS ICE BUILD-UP AND KEEPS SILT AND CONTAMINATION OUT
- FOR TWINSET USE BUT EQUALLY SUITABLE FOR SINGLE OR STAGE CYLINDER CONFIGURATIONS
- DUAL CONFIGURATION: FITS ALL CERTIFYING AGENCIES FROM RSTC TO DIR DIVERS AND ALL XR USES INCLUDING CAVE
- MINIMIZED RISK OF ACCIDENTAL SNAGGING, NO HOSE KINKING AND EASIER ACCESS TO THE MANIFOLD VALVES
- AST - AUTO SEALING TECHNOLOGY
 - KEEPS THE FIRST STAGE DRY. RELIABILITY WITHOUT COMPROMISE
 - THE SYSTEM IS AUTOMATICALLY ACTIVATED BY AIR
 - TESTED WITH OXYGEN IN COLD TEMPERATURES AND DEMANDING ENVIRONMENTS
 - PATENTED SYSTEM
- G5/8 CONNECTION, 300BAR (DIN)
- CERTIFIED WITH THE DR SECOND STAGE



TECHNICAL FEATURES

Type	DIN 300 bar	NITROX 200 bar
Weight	758g / 27oz	757g / 26.7oz
High pressure ports	1 [7/16" UNF]	
Low pressure ports	2 [3/8" UNF]	

*Spare parts, to be used only in first/second stage combinations carrying a CE certification. The assembly, check and any necessary adjustments must be done by a Mares Lab Authorized Service Center.

2XR 1ST STAGE

Code: 416407* - NR: air - G5/8
Code: 416407* - NX: O2 - M26



- VERY SIMPLE AND RELIABLE
- COLD WATER USE
- STURDY AND COMPACT
- EASY TO CLEAN AND MAINTAIN
- AST - AUTO SEALING TECHNOLOGY
 - KEEPS THE FIRST STAGE DRY. RELIABILITY WITHOUT COMPROMISE
 - THE SYSTEM IS AUTOMATICALLY ACTIVATED BY AIR
 - TESTED WITH OXYGEN IN COLD TEMPERATURES AND DEMANDING ENVIRONMENTS
 - PATENTED SYSTEM
- CERTIFIED WITH THE VR SECOND STAGE



TECHNICAL FEATURES

Type	DIN 300 bar	NITROX 200 bar
Weight	431g / 15oz	409g / 14.4oz
High pressure ports	1 [7/16" UNF]	
Low pressure ports	4 [3/8" UNF]	

HOSES



46201394			60 cm / 24 in
46201477	3/8"	RUBBER	110 cm / 43 in
46201393			210 cm / 83 in
47201191			20 cm / 8 in
46201680	3/8"	MIFLEX XT-TECH	60 cm / 24 in
46201681			110 cm / 43 in
46201682			210 cm / 83 in

G5/8 KIT 200BAR W/AST

Code: **416818** for 28XR - 25XR - 2XR

- O2 CLEANED
- AST - AUTO SEALING TECHNOLOGY
 - KEEPS THE FIRST STAGE DRY. RELIABILITY WITHOUT COMPROMISE
 - THE SYSTEM IS AUTOMATICALLY ACTIVATED BY AIR
 - TESTED WITH OXYGEN IN COLD TEMPERATURES AND DEMANDING ENVIRONMENTS
 - PATENTED SYSTEM
- CONICAL SINTERED FILTER

Accessory, to be used only in first/second stage combinations carrying CE certification. The assembly, check and any necessary adjustments must be done by a Mares Lab Authorized Service Center.



OVER PRESSURE RELIEF VALVE

Code: **416404**

- STANDARD LP PORT THREAD, 3/8 UNF
- SET TO 13BAR, NOMINALLY, WITH +/-0.5BAR TOLERANCE
- CHROME PLATED BRASS
- STANDARD REGULATOR SPRING



2ND STAGE LP SWIVEL CONNECTOR

Code: **416413**

- LOW PRESSURE HOSE ADAPTER - 360° SWIVEL
- GOES BETWEEN A REGULATOR HOSE AND 2ND STAGE
- IDEAL FOR A LEFT SIDEMOUNT REGULATOR
- MORE COMFORT ON WAIST-MOUNTED DECO AND STAGE TANKS
- REDUCES JAW FATIGUE
- ALLOWS A WIDER RANGE OF HEAD MOVEMENT



NECK REGULATOR BUNGEE

Code: **415763**

- ATTACHES EASILY TO ANY REGULATOR 2ND STAGE MOUTHPIECE
- ALLOWS REGULATOR TO HANG CLOSE UNDER THE CHIN
- DURABLE, SHAPE RETAINING SILICONE



BK



YL

RUBBER STAGE TANK STRAP

Code: **417527 - 6"**

Code: **417527 - 7"**

- 1 PAIR OF RUBBER LOOP TANK STRAPS
- 2.5 CM WIDE WITH WEBBING PULLER
- 6" FOR 6" DIAMETER TANK (17 CM RUBBER LOOP)
- 7" FOR 7", 8" & 8.5" DIAMETER TANKS (23 CM RUBBER LOOP)



mares XR
extended range

**FARTHER. DEEPER.
BEYOND.**

XR

**EXTEND YOUR RANGE
EXPERIENCE NEW EMOTIONS
ADVANCE A BIT FARTHER**

Don't you think it's time for a little something extra?

We are naturally inclined to be curious and adventurous. You've made it this far after all. Exploring the depths of the ocean realm. Seeking the excitement of what's to come. Just below the water's surface lies a new adventure each and every time. Perhaps you've considered going just a little farther, a bit deeper, or beyond the boundaries you've been to before? Mares is here to discover this along your side. Offering new products that extend your range and limits, to go places you've only dreamed of. The opportunities are infinite, new emotions are endless, and it's just at your fingertips. It's time we went, don't you think?

High quality equipment is instrumental in achieving your goals.

Extended Range is a pathway to exploring the extraordinary. Mares has developed a new line of equipment flexible enough to bridge the gap between taking your first steps into XR, to the most challenging of explorations. No compromises necessary as you advance towards your final goal.

INSTRUMENT SPG52

Code: 414600 - 56cm hose - BAR

Code: 414600 - 56cm hose - PSI

Code: 414606 - 15cm hose Rubber - BAR

Code: 414606 - 15cm hose Rubber - PSI

Code: 414605 - 15cm hose Rubber Oxygen - BAR

Code: 414605 - 15cm hose Rubber Oxygen - PSI

NEW

NEW

- SPG WITH GRADUATION RANGE 0-360 BAR, 0-5000 PSI
- SINGLE READING
- TEMPERED GLASS
- LUMINESCENT "GLOW IN THE DARK" SCREEN
- AIR OR 100% OXY (OXY CLEAN)
- CERTIFIED ACCORDING TO EN 250
- DOUBLE CHROME, MIRROR-PLATED CASE TREATMENT
- BRASS HOUSING WITH TEMPERED GLASS FOR EXTREME DURABILITY
- COPPER BERYLLIUM BOURDON TUBE MECHANISM THAT NEVER GOES OUT OF CALIBRATION EVEN WITH HARD KNOCKS
- PREFERRED FOR ITS SIMPLICITY BY MANY TECHNICAL DIVERS WHO FOLLOW DIR TRAINING PHILOSOPHY



TECHNICAL FEATURES

Weight	210g	7.40oz
Diameter	52mm	2in

STAGE RIGGING SET

Code: 417518

- THE MOST MODULAR SYSTEM FOR CARRYING STAGE TANKS
- FITS ALL DIAMETERS OF STANDARD TANKS
- FITS STAGES OF ALL LENGTHS
- INCLUDES: 1 LARGE STAINLESS STEEL DEAD BOLT SNAP, ADJUSTABLE TANK BAND WITH STAINLESS STEEL BUCKLE AND HI-RESISTANCE CORD



SINGLE TANK BAND SET

Code: 417541

- DEDICATED TO ALL OUR SINGLEMOUNT SETS
- FITS ALL DIAMETERS OF STANDARD TANKS
- INCLUDES: 2 X 52CM WIDE HEAVY DUTY STRAPS WITH 2 STAINLESS STEEL BUCKLES



BUOYANCY SYSTEMS



XR-REC TRIM SINGLE BACKMOUNT SET

Code: 417566



A COMPLETE MOUNTED SET INCLUDING:

- 17 LITER 1000D CORDURA MONO BLADDER FOR SINGLE TANK USE
 - THE LOWER PORTION OF THE BLADDER HAS BEEN EXTENDED TO IMPROVE BUOYANCY AND TRIM
 - ERGONOMIC OVERPRESSURE VALVE PLACEMENT WHICH IS EASY TO USE IN ALL DIVING POSITIONS
 - QUICK TRIM ADJUSTMENT - A SMART, FAST SOLUTION TO FIND YOUR IDEAL TRIM
 - LEFT AND RIGHT SHOULDER BUCKLES
 - INDEPENDENT SHOULDER AND WAIST STRAPS. QUICK AND EASY ADJUSTMENT
 - SHOULDER PADDING FOR BETTER COMFORT
 - ADJUSTABLE CROTCH STRAP WITH 2 BP CONNECTIONS FOR BETTER COMFORT AND STABILITY
 - K-STYLE INFLATOR WITH METAL BUTTONS AND A STRETCHY, OVAL-SHAPED, CORRUGATED HOSE
 - 3 MM SILVER ALU BACK PLATE WITH A LIGHTWEIGHT DESIGN
 - 3 MM SILVER ALU SINGLE TANK ADAPTER
 - 6 MM SILVER ALU D-RINGS
 - 2 TANK STRAPS
- EXTREMELY LIGHT, ONLY 2.8 KG
- 4 COLOUR OPTIONS AVAILABLE: BLACK, BLUE, WHITE AND AQUA
 - ONE SIZE FITS ALL
 - PERFECT FOR TRAVELLING



BK

ACCESSORIES

Standard Weight System	417567	Page 182
Metal Buckle	417562	Page 184
Inflator RE Valve	417564	Page 182
Bent toothed trigliders	417553	Page 184

XR-REC TRIM SINGLE BACKMOUNT SET

Code: 417566



BL

WH

AQ

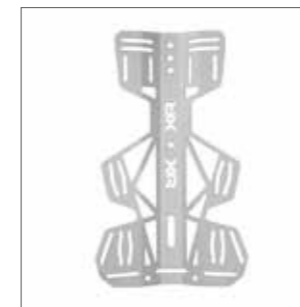

UltraLight Aluminum Backplate - "Skeleton" Design



Quick Trim Adjustment System (2 positions)



Standard Weight System (Optional)

XR-REC TRIM

SINGLE BACKMOUNTED SET



DISCOVER MORE



This innovative, all-in-one, technical buoyancy system is unique amongst other Mares XR systems with its new Quick Trim Adj solution. Divers can now easily adjust their system to create a custom fit and perfect their trim in a matter of minutes.

Mares believes that one of the most important things as a technical diver is trim, hence the 'Trim' name. Mares designed this system's high buoyancy lift with a streamlined design that offers smart solutions to improve trim.

The new "Skeleton" backplate design reduces excessive weight, making it ideal for travel. It features 40% less volume and weight than the standard XR ALU BP 3mm version. This new, wider design also improves tank stability during a dive. The adjustable backplate allows the user to install two tank straps for better tank stability.

Dedicated waist strap slots on the new backplate feature a curved design to increase comfort and help keep the strap in position without additional trigliders. Divers who would like to forgo a weight belt have newly designed, dedicated weight pockets as an optional add-on.

Additional features include two aluminum D-rings on the waist strap, perfect for securing stage tanks, a stainless-steel waist strap buckle that is extremely durable and shoulder protection for unparalleled comfort.

Mares positioned the shoulder straps independently from the waist strap to make customizing the XR-REC Trim fast and easy.

Left and right shoulder buckles help divers with to don and doff their set quickly and easily, especially when in the water. Additionally, it is also possible to replace the buckles with our Mil-Spec Aluminum version that includes a two-point quick-release system.

The XR-REC Trim will be available in four color options: black, white, blue, and aqua.

ENJOY NOT ONLY A CUSTOM FIT, BUT ALSO A CUSTOM LOOK WITH THE XR-REC TRIM SINGLE BACKMOUNT SET

POLYGON SINGLE BACKMOUNT SET

Code: 417563



A COMPLETE MOUNTED SET INCLUDING:

- 16 LITER POLYGON SINGLE TANK DONUT
 - 3 MM BLACK ALU BACKPLATE
 - 6 MM SILVER ALU D-RINGS
 - SILVER STAINLESS STEEL WAIST STRAP BUCKLE
 - STANDARD WEBBING HARNESS
 - K-STYLE INFLATOR WITH METAL BUTTONS AND A STRETCHY, OVAL-SHAPED, CORRUGATED HOSE
 - 2 TANK STRAPS WITH SILVER ALU BUCKLES
 - BLACK FLAT-HEAD BOLT SCREWS
- TOTAL WEIGHT: ONLY 3.1 KG
 - A SINGLE BACKMOUNT SET THAT INCLUDES EVERYTHING YOU NEED TO ENTER THE WORLD OF XR DIVING
 - ONE SIZE FITS ALL (FULLY ADJUSTABLE HARNESS)
 - PERFECT FOR TRAVELLING



ACCESSORIES

Inflator RE Valve	417564	Page 182
Side Weight Pocket	417533	Page 183
Thumbwheel	417523	Page 190
Bent Toothed Trigliders ALU-BK	417552	Page 184

XR-REC ICE SINGLE BACKMOUNT SET

Code: 417565



A COMPLETE MOUNTED SET INCLUDING:

- 16 LITER STANDARD SINGLE TANK SILVER DONUT
 - 6 MM SS316 BACK PLATE
 - 6 MM SS316 D-RINGS
 - SS316 BUCKLE
 - STANDARD WEBBING HARNESS
 - LEFT SHOULDER MILSPEC SS316 BUCKLE WITH A 2-POINT, QUICK-RELEASE SYSTEM
 - K-STYLE INFLATOR WITH METAL BUTTONS AND A STRETCHY, OVAL-SHAPED, CORRUGATED HOSE
 - 2 TANK STRAPS WITH SS316 BUCKLES
 - UPPER HANDLE
 - NEW X-REC BACK-SHOULDERS PADDING
 - FLAT-HEAD BOLT SCREWS
 - 2 REMOVABLE SIDE WEIGHT POCKETS WITH D-RINGS, CLOSED WITH VELCRO® BRAND FASTENERS (ONE POCKET IS EXTENDABLE)
- TOTAL WEIGHT: 7.3 KG
- A SINGLE BACKMOUNT SET THAT INCLUDES EVERYTHING YOU NEED TO ENTER THE WORLD OF XR DIVING
 - ONE SIZE FITS ALL (FULLY ADJUSTABLE HARNESS)
 - IDEAL FOR COLD WATER USE



ACCESSORIES

Inflator RE Valve	417564	Page 182
D-Ring SS316 Flat	417525	Page 184
D-Ring SS316 Bent	417526	Page 184
Bent Toothed Trigliders	417553	Page 184

XR-REC SILVER SINGLE BACKMOUNT SET

NEW

Code: 417570

A COMPLETE MOUNTED SET INCLUDING:

- 16 LITER STANDARD SINGLE TANK SILVER DONUT
 - 3 MM SILVER ALU BACK PLATE
 - 6 MM SILVER ALU D-RINGS
 - SS316 SILVER BUCKLE
 - STANDARD WEBBING HARNESS
 - LEFT SHOULDER MILSPEC SILVER ALU BUCKLE WITH A 2-POINT, QUICK-RELEASE SYSTEM
 - 2 TANK STRAPS WITH SILVER SS316 BUCKLES
 - UPPER HANDLE
 - K-STYLE INFLATOR WITH METAL BUTTONS AND A STRETCHY, OVAL-SHAPED, CORRUGATED HOSE
 - NEW X-REC BACK-SHOULDERS PADDING
 - BLACK FLAT-HEAD BOLT SCREWS
 - 2 REMOVABLE SIDE WEIGHT POCKETS WITH D-RINGS, CLOSED WITH VELCRO® BRAND FASTENERS (ONE POCKET IS EXTENDABLE)
- TOTAL WEIGHT: 3.4 KG
- A SINGLE BACKMOUNT SET THAT INCLUDES EVERYTHING YOU NEED TO ENTER THE WORLD OF XR DIVING
 - ONE SIZE FITS ALL (FULLY ADJUSTABLE HARNESS)
 - PERFECT FOR TRAVELLING



ACCESSORIES

Inflator RE Valve	417564	Page 182
Standard Weight System	417567	Page 182
Thumbwheel SS316	417523	Page 190
D-rings SS316 Flat	417525	Page 184

HEAVY DUTY HARNESS

Code: 417501 - Complete

- WEBBING
- 3.5M WEBBING WITH CENTER HOLE AND GROMMET
 - 3 X 40MM ELASTIC LOOP RETAINERS
 - 1.5M CROTCH STRAP
- HARNESS
- 2 X BENT D-RING 50MM STAINLESS STEEL
 - 2 X STRAIGHT D-RING 50MM STAINLESS STEEL
 - 4 X 3-BAR SLIDES NORMAL STAINLESS STEEL
 - 2 X 3-BAR SLIDES TOOTHED STAINLESS STEEL
 - 1 X WAIST BUCKLE STAINLESS STEEL
- CROTCH STRAP
- 2 X STRAIGHT D-RINGS 50MM STAINLESS STEEL
 - 1 X 3-BAR GLIDES 50MM STAINLESS STEEL
 - DIR - HOGARTHIAN CONFIGURATION



HEAVY LIGHT HARNESS

Code: 417502 - Complete

- WEBBING
- 3.5 M WEBBING WITH CENTER HOLE AND GROMMET
 - 3 X 40MM ELASTIC LOOP RETAINERS
 - 1.5M CROTCH STRAP
- HARNESS
- 2 X BENT D-RING 50MM BLACK ALUMINUM
 - 2 X STRAIGHT D-RING 50MM BLACK ALUMINUM
 - 4 X 3-BAR SLIDES NORMAL BLACK ALUMINUM
 - 2 X 3-BAR SLIDES TOOTHED BLACK ALUMINUM
 - 1 X SS316 STANDARD WAIST BUCKLE
- CROTCH STRAP
- 2 X STRAIGHT D-RINGS 50MM BLACK ALUMINUM
 - 1 X 3-BAR GLIDES 50MM BLACK ALUMINUM
 - DIR - HOGARTHIAN CONFIGURATION

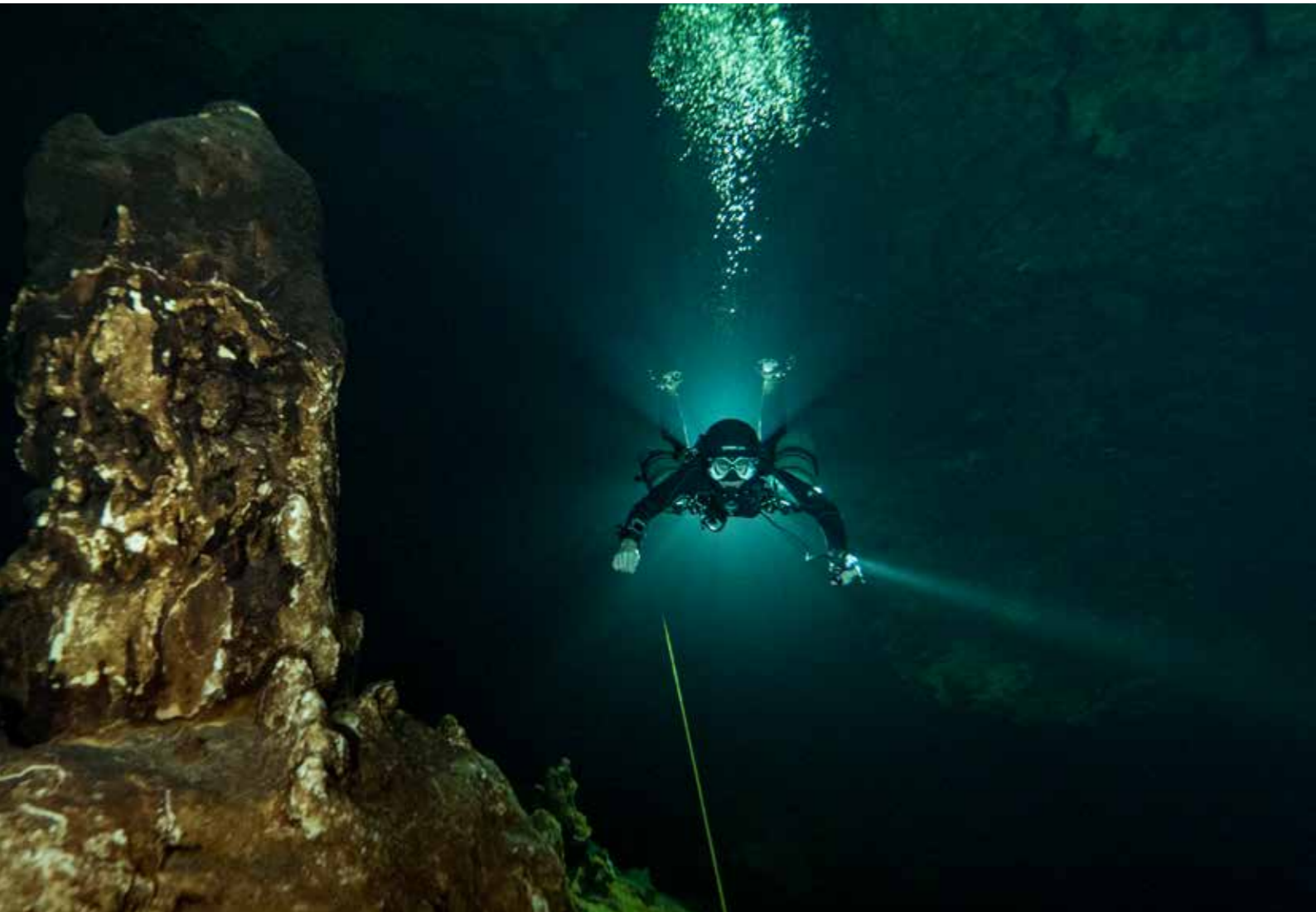

HEAVY DUTY MOUNTED SYSTEM

Code: 417516 - 3mm Mounted System

Code: 417516 - 6mm Mounted System

- 417501: HEAVY DUTY HARNESS - COMPLETE
- TOTAL WEIGHT:
 - 3MM VERSION 2.6 KG
 - 6MM VERSION 4.5 KG
- GRADE 316 STAINLESS STEEL BACKPLATE
 - 13 LASER CUT, LASER ETCHED SLOTS:
 - 8 SLOTS SPECIALLY DESIGNED FOR OPTIMUM POSITIONING OF THE HARNESS WEBBING
 - 2 UPPER AND 2 LOWER SLOTS FOR NYLON CYLINDER BANDS SO A SINGLE CYLINDER CAN BE STRAPPED DIRECTLY
 - HAVING ONLY 2 SLOTS PROVIDES ENOUGH LATERAL CYLINDER STABILITY WITHOUT WEAKENING THE STRENGTH OF THE SPINE
 - 2" WIDE CROTCH STRAP SLOT
 - 15 HOLES:
 - 3 HOLES AT THE TOP OF THE PLATE OFFER A RANGE OF HEIGHT ADJUSTMENTS FOR BUOYANCY CELLS AND CYLINDERS. IN ADDITION, A CORRESPONDING LOWER CENTER SLOT ALLOWS FOR LOWER BAND BOLTS THAT ARE MISALIGNED
 - 4 UPPER AND LOWER PERIMETER HOLES ALONG EITHER SIDE AND 4 HOLES ALONG THE BOTTOM ALLOW FOR THE MOUNTING OF ACCESSORIES AND A SIDE-MOUNT BUTT PLATE
- BENT LOWER EDGES
- HIGHLY TECHNICAL SHAPE
- ULTRA-RUGGED BACKBONE
- TOTAL MODULARITY: FOR ALL ALL DONUTS/WINGS



HEAVY LIGHT MOUNTED SYSTEM

Code: 417517 - 3mm Mounted System

- 417502: HEAVY LIGHT HARNESS - COMPLETE
- TOTAL WEIGHT: ONLY 1.4 KG
- 3MM, 6061 MARINE GRADE ANODIZED ALUMINUM ALLOY BACKPLATE
 - 13 LASER CUT AND LASER ETCHED SLOTS:
 - 8 SLOTS SPECIALLY DESIGNED FOR OPTIMUM POSITIONING OF THE HARNESS WEBBING
 - 2 UPPER AND 2 LOWER SLOTS FOR NYLON CYLINDER BANDS SO A SINGLE CYLINDER CAN BE STRAPPED DIRECTLY
 - HAVING ONLY 2 SLOTS PROVIDES ENOUGH LATERAL CYLINDER STABILITY WITHOUT WEAKENING THE STRENGTH OF THE SPINE
 - 2" WIDE CROTCH STRAP SLOT
 - 15 HOLES:
 - 3 HOLES AT THE TOP OF THE PLATE OFFER A RANGE OF HEIGHT ADJUSTMENTS FOR BUOYANCY CELLS AND CYLINDERS. IN ADDITION, A CORRESPONDING LOWER CENTER SLOT ALLOWS FOR LOWER BAND BOLTS THAT ARE MISALIGNED
 - 4 UPPER AND LOWER PERIMETER HOLES ALONG EITHER SIDE AND 4 HOLES ALONG THE BOTTOM ALLOW FOR MOUNTING ACCESSORIES AND SIDE-MOUNT BUTT PLATE
- BENT LOWER EDGES
- HIGHLY TECHNICAL SHAPE
- ULTRA-RUGGED BACKBONE
- PUSHED TO LIMITS THROUGH INTENSE TESTING
- TOTAL MODULARITY: FOR ALL DONUTS/WINGS



STANDARD WEIGHT SYSTEM

Code: **417567 Pair**

- AN ADD-ON TO UPGRADE YOUR BCD
- EACH POCKET HOLDS UP TO 4KG
- 1200 "BULLETPROOF" BALLISTIC NYLON AND 600D POLYESTER EXTERIOR
- EASY TO INSERT, EVEN WHEN FULL
- ONE-HANDED USE
- SAFE AND RELIABLE LOCKING SYSTEM



DISCOVER MORE



CARGO POCKET

Code: **417505**

- 1200D "BULLETPROOF" BALLISTIC NYLON
- LARGE MAIN VOLUME POCKET WITH ZIPPERED CLOSURE
- INTERNAL BUNGEE CORD
- INTERNAL STAINLESS STEEL D-RING
- SMALL FRONT COMPARTMENT POCKET WITH ZIPPERED CLOSURE
- 2 LARGE NYLON LOOPS TO SLIDE OVER HARNESS BELT
- 2 SMALL NYLON LOOPS TO ATTACH POCKET TO STANDARD 2" WAISTBAND
- 2 BOTTOM DRAIN GROMMETS
- CAN BE ATTACHED TO YOUR HARNESS



MASK POCKET

Code: **417506**

- 1200D "BULLETPROOF" BALLISTIC NYLON
- 600D POLYESTER WEB GRID
- LARGE AND EXPANDABLE
- INNER REINFORCEMENT IN BLACK POLYURETHANE
- 1 OVERSIZED CLIP
- LONG NYLON STRAP ALLOWING FULL POCKET EXPANSION
- 1 LARGE NYLON LOOP TO SLIDE OVER HARNESS BELT
- CAN BE ATTACHED TO YOUR HARNESS



INFLATOR RE VALVE

Code: **417564**

- THE BEST SOLUTION FOR RECREATIONAL AND TECH DIVES
- LONG INFLATOR WITH METAL BUTTONS AND A RAPID EXHAUST VALVE

- THE COMPLETE SET, INCLUDES:
 - CPL INFLATOR
 - LP HOSE
 - GASKET

- CAN BE USED WITH THE FOLLOWING MODELS:
 - XR-REC ICE (417565)
 - POLYGON (417563)
 - XR-REC SILVER (417570)
 - DONUTS (417568 SINGLE TANK - 417569 TWIN TANK)



DISCOVER MORE



SIDEMOUNT BACK WEIGHT

Code: **417532**

- HOLDS UP TO 12KG
- 1200D "BULLETPROOF" BALLISTIC NYLON AND 600D POLYESTER EXTERIOR
- HEAVY DUTY COLD WATER VELCRO® BRAND CLOSURE SYSTEM
- ATTACHMENT GROMMETS ON TOP AND BOTTOM FOR MODULAR FIXING ON SIDEMOUNT PLATES
- 3 BACK STRAPS FOR ADJUSTABLE ATTACHMENT ON HARNESS



SIDE WEIGHT POCKET

Code: **417533**

- HOLDS UP TO 4KG
- 1200D "BULLETPROOF" BALLISTIC NYLON AND 600D POLYESTER EXTERIOR
- MODULAR - THEY CAN BE INSTALLED ON ANY MARES XR HARNESS
- CAN BE PLACED ON WAIST STRAPS
- HEAVY DUTY COLD WATER VELCRO® BRAND CLOSURE SYSTEM
- INTEGRATED FLAT D-RING



SIDEMOUNT BACK POUCH

Code: **417534**

- 1200D "BULLETPROOF" BALLISTIC NYLON AND 600D POLYESTER EXTERIOR POSTERIOR POUCH
- ZIPPERED FRONT
- 316 STAINLESS STEEL D-RINGS TO ATTACH FASTENING
- VERY USEFUL ACCESSORY FOR ALL SIDEMOUNT DIVERS ENABLING YOU TO STOW AWAY EVERYTHING THAT YOU WOULD NORMALLY CARRY IN YOUR POCKETS
- FAST AND EASY WATER DRAINAGE
- OUTER MESH POCKET FOR STORAGE OF SLATES, DIVE TABLES OR WETNOTES
- DOUBLE ENDERS NOT PROVIDED



RUBBER RINGS

Code: **417549**

- RUBBER SLIDING D-RING COMPATIBLE WITH ALL 50/52MM WEBBING
- CAN BE MOVED FORWARDS (BY PINCHING TOGETHER) WHEN CYLINDERS START BECOMING MORE BUOYANT TO ALLOW FOR BETTER TRIM CONTROL
- FITS SNUGLY
- WEIGHT: 0.01KG
- OUTER DIAMETER: ~50MM
- THICKNESS: 8MM
- 4 PCS



TOOTHED SS316 TRIGLIDERS

Code: **417524**

- ACCESSORIES FOR ADDITIONAL CONFIGURATION
- PRECISION MACHINED FROM SS AISI 316
- FITS WITH ALL HARNESS STRAPS
- 10 PCS



BENT TOOTHED TRIGLIDERS

Code: **417552 - Alu Black**

Code: **417553 - SS316**

- REPLACES THE CLASSICAL CHEST TRIGLIDERS ALLOWING FOR THE ADDITION OF ANY BACKUP LIGHTS OR ADDITIONAL ACCESSORIES
- PRECISION MACHINED FROM SS316 OR ALU
- STRONG, DURABLE, FITS WITH ALL HARNESS STRAPS
- 2 PCS



D-RINGS SS316 FLAT

Code: **417525**

- ACCESSORIES FOR ADDITIONAL CONFIGURATION
- PRECISION MACHINED FROM SS AISI 316
- FITS WITH ALL HARNESS STRAPS
- 10 PCS



D-RINGS SS316 BENT

Code: **417526**

- ACCESSORIES FOR ADDITIONAL CONFIGURATION
- PRECISION MACHINED FROM SS AISI 316
- FITS WITH ALL HARNESS STRAPS
- 10 PCS



SF2 SS316 CLIP

Code: **417522**

- ALLOWS FREE ADJUSTMENT OF RIGHT HARNESS STRAP
- PRECISION MACHINED FROM SS316 OR ALU
- STRONG, DURABLE, LOGICAL ALTERNATIVE TO PLASTIC CLIPS
- FITS IN ALL OUR RIGID PLATES (ALU AND SS)



METAL BUCKLE

Code: **417562 - Alu Silver**

Code: **417556 - Alu Black**

Code: **417555 - SS316**

- MILSPEC FOR 50MM WEBBING, STRAPS AND HARNESSES
- TWO-POINT QUICK-RELEASE SAFETY CONCEPT ALLOWING A BREAK IN THE HARNESS



DONUT BLADDER SINGLE TANK **NEW**

Code: **417568 - 10 kg**

Code: **417568 - 16 kg**

- DRAINS: 6 LARGE GROMMETS, 2 ON TOP AND 4 ON BOTTOM
- 1200D "BULLETPROOF" BALLISTIC NYLON AND 600D POLYESTER EXTERIOR
- HEAVY DUTY PLASTIC ZIPPER AND SLIDER WITH ELONGATED TEETH
- 4 HEAVY DUTY GROMMETS
- LONGER TANK BELT GROOVES TO ALLOW OPTIMUM TRIM
- STRETCHY, LOW PROFILE, OVAL CORRUGATED HOSE
- K-STYLE INFLATOR WITH METAL BUTTONS
- LEFT POSITION DOES NOT INTERFERE WITH 1ST STAGE DUMP VALVE
- LOW PROFILE DUMP VALVE
- MICRO PULLER
- TANK STABILIZER BODY SLIDE BARS
- STYLISH, DURABLE (RESISTANT TO TEARS, SCUFFS AND ABRASIONS), LIGHTWEIGHT AND LONG-LASTING
- VERY SMART AND UNIQUE DESIGN ALLOWING THE CYLINDER TO NEST INSIDE
- EXTREMELY STREAMLINED - VERY STABLE CONTINUOUS LOOP SHAPE
- SMOOTH GAS SHIFT FROM LEFT TO RIGHT
- TOP QUALITY ZIPPER: DOES NOT INTERFERE WITH THE WOVEN TEXTILE TAPE, EASY HANDLING, STRONG AND DURABLE



DONUT BLADDER TWIN TANK **NEW**

Code: **417569 - 20 kg**

Code: **417569 - 24 kg**

- DRAINS: 6 LARGE GROMMETS, 2 ON TOP AND 4 ON BOTTOM
- 1200D "BULLETPROOF" BALLISTIC NYLON AND 600D POLYESTER EXTERIOR
- HEAVY DUTY PLASTIC ZIPPER AND SLIDER WITH ELONGATED TEETH
- 4 HEAVY DUTY GROMMETS POSITIONED TO ALLOW OPTIMUM TRIM
- STRETCHY, LOW PROFILE, OVAL CORRUGATED HOSE
- K-STYLE INFLATOR WITH METAL BUTTONS
- MID POSITION DOES NOT INTERFERE WITH 1ST STAGE DUMP VALVE
- RIGHT AND LEFT MODULAR LOW PROFILE DUMP VALVE AND BLINDER
- KNOBLESS PULLER
- EXTREMELY STREAMLINED - VERY STABLE CONTINUOUS LOOP SHAPE
- SMOOTH GAS SHIFT OF AIR FROM LEFT TO RIGHT
- TOP QUALITY ZIPPER: EASY HANDLING, STRONG AND DURABLE



SIDEMOUNT PLATES

- 6MM GRADE 316 STAINLESS STEEL
- LASER CUT AND LASER ETCHED EDGES
- HIGHLY TECHNICAL PRE-SHAPE - UNPARALLELED VERSATILITY
- ULTRA-RUGGED - PUSHED TO THE LIMITS THROUGH INTENSE TESTING
- TOTAL MODULARITY: ALL TYPES OF SIDEMOUNTING

SIDEMOUNT TOP PLATE

Code: 417528

- 460G



SIDEMOUNT BOTTOM PLATE

Code: 417529

- 400G



SIDEMOUNT TAIL PLATE

Code: 417530

- 180G



SIDEMOUNT HIP RINGS

Code: 417531 (Right & Left)

- 105G EACH



SIDEMOUNT ALU PLATES

- ANODIZED ALUMINUM 40M
- LASER CUT AND LASER ETCHED EDGES
- HIGHLY TECHNICAL PRE-SHAPE - UNPARALLELED VERSATILITY
- ULTRA-RUGGED - PUSHED TO THE LIMITS THROUGH INTENSE TESTING
- TOTAL MODULARITY: ALL TYPES OF SIDEMOUNTING

SIDEMOUNT TOP PLATE ALU

Code: 417543

- 76G



SIDEMOUNT BOTTOM PLATE ALU

Code: 417544

- 72G



SIDEMOUNT TAIL PLATE ALU

Code: 417545

- 66G

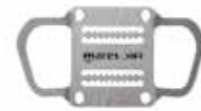

SIDEMOUNT HIP ALU RINGS

Code: 417546 (Right & Left)

- 42G EACH



SIDEMOUNT PURE LIGHT BLADDER

Code: 417536

- 10 LITERS - FULLY COMPATIBLE WITH ALL HARNESSES FROM THE RANGE
- 1200D "BULLETPROOF" BALLISTIC NYLON AND 600D POLYESTER EXTERIOR
- INNER AIR CELL: BLACK POLYURETHANE
- HEAVY DUTY PLASTIC ZIPPER AND SLIDER WITH ELONGATED TEETH - DOES NOT INTERFERE WITH WOVEN TEXTILE TAPE, EASY TO HANDLE, STRONG AND DURABLE
- FULLY MODULAR TRIM: CAVE, OPEN WATER, WRECK - COLD AND WARM WATERS
- WAVE SHAPE FOR PERFECT ENVELOPMENT OF THE BACK WEIGHT POUCH
- NO BUNGEEES COMPRESSING THE BODY ALLOWING COMFORT AND OPTIMAL TRIM
- NO CAMEL OR CAKE EFFECT WITH PRE-SHAPED INTERNAL BLADDER ALLOWING PERFECT FLAT TRIM
- REVERSIBLE LOW PROFILE DUMP VALVE / INFLATOR
- KNOBLESS PULLER
- STRETCHY, LOW PROFILE, OVAL CORRUGATED HOSE
- K-STYLE TWO-SPEED (STANDARD AND TURBO) INFLATOR WITH BRASS BUTTONS
- STYLISH, DURABLE, LIGHTWEIGHT AND LONG-LASTING, FINEST QUALITY MATERIALS



SIDEMOUNT HEAVY PURE BLADDER

Code: 417542

- BEST FOR SS316 PLATES, LOCAL DIVING, COLD WATERS, HEAVY DECOMPRESSION, DEEP DIVING
- 16 LITERS - FULLY COMPATIBLE WITH ALL HARNESSES FROM THE RANGE
- 1200D "BULLETPROOF" BALLISTIC NYLON AND 600D POLYESTER EXTERIOR
- INNER AIR CELL: BLACK POLYURETHANE
- HEAVY DUTY PLASTIC ZIPPER AND SLIDER WITH ELONGATED TEETH - DOES NOT INTERFERE WITH WOVEN TEXTILE TAPE, EASY TO HANDLE, STRONG AND DURABLE
- FULLY MODULAR TRIM: CAVE, OPEN WATER, WRECK - COLD AND WARM WATERS
- WAVE SHAPE FOR PERFECT ENVELOPMENT OF THE BACK WEIGHT POUCH
- NO BUNGEEES COMPRESSING THE BODY ALLOWING COMFORT AND OPTIMAL TRIM
- NO CAMEL OR CAKE EFFECT WITH PRE-SHAPED INTERNAL BLADDER ALLOWING PERFECT FLAT
- REVERSIBLE LOW PROFILE DUMP VALVE / INFLATOR
- KNOBLESS PULLER
- STRETCHY, LOW PROFILE, OVAL CORRUGATED HOSE
- K-STYLE TWO-SPEED (STANDARD AND TURBO) INFLATOR WITH BRASS BUTTONS
- STYLISH, DURABLE (RESISTANT TO SCUUFFS, TEARS AND ABRASIONS), LIGHTWEIGHT AND LONG-LASTING FINEST QUALITY MATERIALS



PURE LIGHT SIDEMOUNT SET

Code: 417547

- A COMPLETE MOUNTED SET INCLUDING:
- 417536 - SIDEMOUNT PURE LIGHT BLADDER - 10 LITERS
 - 417543 - SIDEMOUNT TOP ALU PLATE
 - 417544 - SIDEMOUNT BOTTOM ALU PLATE
 - 417545 - SIDEMOUNT TAIL ALU PLATE
 - 417546 - SIDEMOUNT HIP ALU RINGS (R&L)
 - 417502 - HARNESS HEAVY LIGHT COMPLETE
 - 417532 - SIDEMOUNT BACK WEIGHT
 - 417534 - SIDEMOUNT BACK POUCH
 - 417535 - SIDEMOUNT STAGE BUNGEEES



ALUMINUM 40L

HEAVY PURE SIDEMOUNT SET

Code: 417548

- A COMPLETE MOUNTED SET INCLUDING:
- 417542 - SIDEMOUNT HEAVY PURE BLADDER - 16 LITERS
 - 417528 - SIDEMOUNT TOP SS316 PLATE
 - 417529 - SIDEMOUNT BOTTOM SS316 PLATE
 - 417530 - SIDEMOUNT TAIL SS316 PLATE
 - 417531 - SIDEMOUNT HIP SS316 RINGS (R&L)
 - 417501 - HARNESS HEAVY DUTY COMPLETE
 - 417532 - SIDEMOUNT BACK WEIGHT
 - 417534 - SIDEMOUNT BACK POUCH
 - 417535 - SIDEMOUNT STAGE BUNGEEES



STAINLESS STEEL



XR-REC BACK-SHOULDERS PADDING

Code: 417560

- ULTIMATE IN COMFORT AND CONVENIENCE WITHOUT SACRIFICING ANY FEATURES
- LUMBAR REINFORCEMENT
- FAST DRAINING CONCEPT
- ERGONOMIC, COMPACT SHOULDER PADS
- NON-TWISTING SHOULDER DESIGN
- COMPACT, INTEGRATED BACK POCKET TO CARRY A LIFTING DEVICE
- ROUND DEADBOLT SCREWS (417521) NOT INCLUDED
- FOR A 6MM BACKPLATE USE 9MM SCREWS
- FOR A 3MM BACKPLATE USE 6MM SCREWS



SIDEMOUNT STAGE BUNGEEES

Code: 417535

- INDEPENDENT BUNGEEES
- 52CM LONG PAIR OF BUNGEEES TO BE ATTACHED TO THE BACK/SHOULDER PLATE
- BOLT SNAPS ATTACHED TO THE FREE ENDS OF THE BUNGEEES
- TO BE STRETCHED AROUND THE NECK OF THE CYLINDER WITH BOLT SNAP CLIPPED ON A CHEST MOUNTED HARNESS D-RING
- CAN BE USED WITH ANY VALVES - MATCHED (LEFT & RIGHT HAND) VALVES ARE NOT REQUIRED



DELUXE PADDING

Code: 417504

- ADJUSTABLE SHOULDER PADS
- MOVABLE VELCRO® BRAND FASTENER TABS FOR A CUSTOM FIT AROUND SHOULDER, D-RING AND HARNESS ACCESSORIES
- INTEGRATED STORAGE COMPARTMENT TO CARRY LIFT DEVICES
- ULTIMATE IN COMFORT AND CONVENIENCE WITHOUT SACRIFICING ANY FEATURES
- SHOULDER MOUNTED D-RINGS CAN EASILY BE MOVED TO THE DESIRED LOCATION WITHOUT AFFECTING THE SHOULDER PAD



S.T.R.A.W.S.

Code: 417557

- SINGLE TANK REMOVABLE ADDITIONAL WEIGHT SYSTEM
- A SIMPLE, LIGHTWEIGHT, DURABLE WEIGHT POCKET, ADDED DIRECTLY ON THE TANK BANDS
- ONE SIDE, OR BETTER, TWO, ALLOW FOR ADDITIONAL WEIGHT
- SIGNIFICANTLY IMPROVES TRIM, ALLOWS TRIM FINE TUNING
- IMPROVES BACK COMFORT
- STABILIZES THE TANK



DRY SUIT INFLATION MOUNTING BAND

Code: **417503**

- INFLATION TANK MOUNTING STRAP WITH BUCKLE
- FOR MOUNTING A SMALL 0.85L OR 1L STEEL AIR OR ARGON BOTTLE DIRECTLY ON A BACK PLATE
- SUITABLE ESPECIALLY FOR COLD, DEEP, WRECK OR CAVE DIVING
- A SECONDARY BOTTLE FILLED WITH ARGON IS THE MOST COMMON METHOD USED TO INCREASE INSULATION PROPERTIES OF THERMAL GARMENTS
- PROVIDES A QUICK, SECURE AND LIGHTWEIGHT MOUNTING OPTION FOR DRY SUIT INFLATION SOURCES
- NOT AVAILABLE IN NORTH AMERICA



STAXR SINGLE TANK ADAPTER

Code: **417561**

- FOR DIVERS WHO NEED EASY TRANSITIONING BETWEEN A SINGLE TANK AND DOUBLE TANK SETUP
- QUICK AND EASY ATTACHMENT OF A SINGLE TANK TO A BACK PLATE
- FITS PERFECTLY ON THE CYLINDER BODY
- SMALL AND COMPACT WITH A UNIQUE XR DESIGN
- MADE IN MARINE GRADE 316 STAINLESS STEEL

NOTE: STA DOES NOT INCLUDE STRAPS AND HARDWARE



DEADBOLT SCREW FLAT

Code: **417520 - 11mm Chrome**

- STRONG, DURABLE SCREW FOR ALL ATTACHMENTS
- PRECISION MADE FROM AISI 316 GRADE STAINLESS STEEL
- 11MM FLAT HEAD DEAD BOLT SCREW WITH O-RINGS
- ACCESSORIES FOR ADDITIONAL CONFIGURATION
- 4PCS (1PC = MALE + FEMALE + O-RINGS)
- USE O-RINGS WITH ALUMINUM PLATES TO PREVENT ANODIZING



DEADBOLT SCREW FLAT

Code: **417538 - 11mm Black**

- STRONG, DURABLE SCREW FOR ALL ATTACHMENTS
- PRECISION MADE FROM AISI 316 GRADE STAINLESS STEEL
- 11MM FLAT HEAD DEAD BOLT SCREW WITH O-RINGS
- ACCESSORIES FOR ADDITIONAL CONFIGURATION
- 4PCS (1PC = MALE + FEMALE + O-RINGS)
- USE O-RINGS WITH ALUMINUM PLATES TO PREVENT ANODIZING



DEADBOLT SCREW ROUND

Code: **417521 - 6mm and 9mm**

- STRONG, DURABLE SCREW FOR ALL ATTACHMENTS
- PRECISION MADE FROM AISI 316 GRADE STAINLESS STEEL
- ROUNDED HEAD - 6 MM AND 9 MM
- ACCESSORIES FOR ADDITIONAL CONFIGURATION
- 4PCS (1PC = MALE + FEMALE + O-RINGS)



THUMBWHEEL SS316

Code: **417523 - 28 x 20 mm**

Code: **417523 - 28 x 16 mm**

- PRECISION MADE FROM AISI 316 STAINLESS STEEL
- STRONG AND DURABLE
- AN EASY ALTERNATIVE TO THE TRADITIONAL WINGNUT/BUTTERFLY
- KNURLED SURFACE FOR EASIER GRIP
- 2 PCS



INSULATION SYSTEMS



XR3 NEOPRENE

Code: **412149 Neoprene/Latex Dry Suit**

Code: **412034 Neo Socks Dry Suit**

- NEW HIGH-DENSITY, HYPER-FLEXIBLE 4MM NEOPRENE - TOUGH BUT FLEXIBLE
- LARGE, PRE-MOUNTED, COMFORTABLE, ADJUSTABLE ELASTIC SUSPENDERS
- 4 mm NEOPRENE NECK
- NEW REDEFINED, ENHANCED DESIGN, TESTED FOR SIZING, OFFERING MAXIMUM FLEXIBILITY
- 1 NEOPRENE, WIDE-ZIPPERED POCKET ON THE RIGHT LEG
- NEW HIGHLY-DURABLE KEV/XR REINFORCEMENTS FOR PROTECTION ON THE KNEES, SHOULDERS AND POSTERIOR
- BACK MOUNTED DRY ZIP - MARES XR EXCLUSIVE INLET AND OUTLET VALVES
- DRY SEAL AROUND NECK (VELCRO) AND COMPLETE COVERAGE FROM THE HOOD TO AVOID WATER EXPOSURE
- NEW 4 mm DRY SMOOTH HOOD
- NEW STRONGER MAT BAG

412149:

- INTEGRATED 4 mm NEOPRENE BOOTS WITH A RIGID SOLE
- REINFORCED BOOT INSTEP AND ADJUSTABLE VELCRO ANKLE STRAP FOR PERFECT CLOSURE
- LATEX WRIST SEALS (ALLOWING FOR USE OF DRY GLOVES)

412034:

- 4 mm SOFT NEOPRENE SOCKS
- NEOPRENE WRIST SEALS



DETAILS



412149 - Boots with rigid sole

412034 - Neoprene socks

412149 / TECHNICAL FEATURES

Sizes	S	M	L	XL	XXL	3XL
-------	---	---	---	----	-----	-----

412034 / TECHNICAL FEATURES

Sizes	S	M	L	XL	XXL
-------	---	---	---	----	-----

SIZE CHART* / XR3

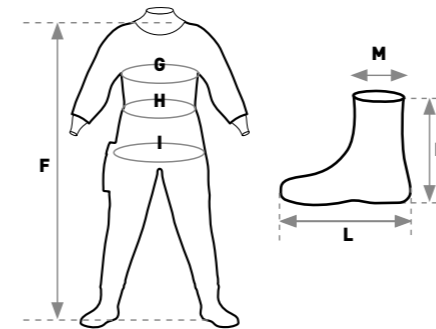
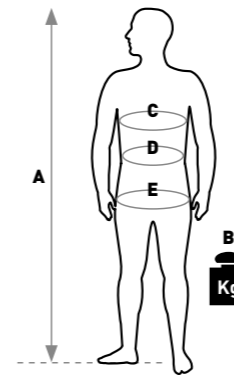

	XS	S	M	L	XL	2XL	3XL
A	149/159	156/166	163/173	170/180	177/187	184/194	190/200
B	45/55	55/65	65/75	75/85	85/95	95/105	105/115
C	79/87	85/93	91/99	99/107	105/113	113/121	119/127
D	61/69	69/77	77/85	85/93	93/101	101/109	109/117
E	68/76	80/88	92/100	96/104	104/112	112/120	120/128

	XS	S	M	L	XL	2XL	3XL
F	119	126	133	140	147	154	160
G	90	96	102	110	116	124	130
H	72	80	88	96	104	112	120
I	79	91	103	107	115	123	131

	XS	S	M	L	XL	2XL	3XL
K	25	25	25	25	25	25	25
L	23,9	25	25,9	27	28	28,2	30,3
M	34	35	36	37	38	39	40

* cm/kg

TEK SHORTS

Code: **412032**

- TO BE WORN ON TOP OF A WET SUIT OR ALONE IN WARM WATER
- MADE OF SUPER LIGHT BILAMINATE AND KEVLAR
- NON-FLOATING, FAST DRAINING AND FAST DRYING
- ULTRA-LIGHT BUT EXTREMELY RESISTANT



TECHNICAL FEATURES

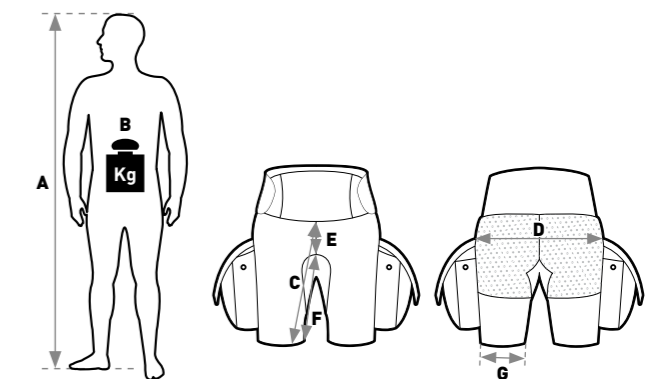

DETAILS



	S	M	L	XL	2XL	3XL
A	-	156/166	163/173	170/180	177/187	184/194
B	-	55/65	65/75	75/85	85/95	95/105
TOLERANCE	S	M	L	XL	2XL	3XL
C	± 1.5 cm	58	62	65	69	72
D	± 2.0 cm	118	130	144	152	160
E	± 0.5 cm	28	29.5	31	32.5	34
F	± 0.5 cm	32	34	36	38	40
G	± 0.5 cm	46	50	55	57	60

DRY-BASE UNDERGLOVES

Code: **412761 - 2mm**

- DESIGNED FOR USE UNDER DRY GLOVES WHILST MAINTAINING MAXIMUM DEXTERITY
- RETAIN SOME PROTECTION IN CASE OF DRY GLOVE FAILURE OR FLOODING
- CAN BE USED WITH TRADITIONAL THINSULATE GLOVES UNDER DRY GLOVES FOR EXTREME CONDITIONS
- DOUBLE LINED, ULTRA-STRETCH NEOPRENE
- SHORT WRIST



TECHNICAL FEATURES

Thickness	2mm		
Sizes	XS/S	M/L	XL/XXL

XR3 DRY SMOOTH HOOD

Code: **415799 - 4mm**

Code: **415800 - 7mm**

- HIGH-QUALITY, ULTRA-STRETCH NEOPRENE
- PERFECT ANATOMICAL FIT
- COMES AS STANDARD IN 4MM WITH THE XR3



TECHNICAL FEATURES

Thickness	4mm / 7mm			
Sizes	XS/S	M/L	XL	XXL/4XL

P-VALVE

Code: **415802**

- TRIMMED P-VALVE
- SOLID DELRIN BODY
- COVER DESIGNED FOR EASY GRIP AND OPERATION WITH DRY GLOVES
- MINIMAL PUSH PRESSURE AND BACKPRESSURE
- EASY MAINTENANCE - NO FAIL KISS DESIGN
- SAFETY LOCK
- GREATLY REDUCES RISK OF DECOMPRESSION SICKNESS BY ENCOURAGING PRE-DIVE HYDRATION
- ENHANCED DIVE COMFORT
- INCLUDES TUBE AND OPTIMIZED SEALING FLANGE
- INCLUDES QUICK DISCONNECT FOR SHE-P



TEK GLOVES

Code: **412760**

- 3 UNCOVERED FINGERS (THUMB, INDEX, MIDDLE)
- DOUBLE-LINED NEOPRENE, WITH AMARA 2MM INSERTS
- BEST DESIGN FOR MAINTAINING TOUCH WHEN 'BLIND' DIVING



TECHNICAL FEATURES

Thickness	2mm						
Sizes	XXS	XS	S	M	L	XL	XXL

DRY SUIT ROCK BOOTS

Code: **412629**

- PERFECT PROTECTION FOR DRY SUITS WITH NEOPRENE SOCKS
- SUPPORT THE FEET AND REDUCE AIR MIGRATION - NO AIR POCKETS
- VERY STRONG AND RESISTANT RUBBER WITH RUGGED, ANTI-SLIP SOLE
- MAXIMUM WATER DRAINAGE



TECHNICAL FEATURES

Thickness	2mm					
Sizes	S	M	L	XL	XXL	3XL

GREY SILICONE SEALS ACCESSORIES

NECK

Code: **415781**

Code: **415783 Small**

WRIST BOTTLENECK (1PAIR)

Code: **415782**

Code: **415784 Small**



COMFORT MID BASE LAYER

Code: **412148**

- CAN BE USED AS A BASE LAYER OR A MID-LAYER - PERFECT FOR NEOPRENE DRY SUITS
- EXA-STRETCH ELASTANE FOR ENHANCED STRETCH AND MOVEMENT
- ANTI-ODOR, WASHABLE, BREATHABLE, MOISTURE-WICKING POLYESTER
- BREATHABLE, FLEECE-LINED, WINDPROOF, WATER-RESISTANT PANELS
- TRAPS A LAYER OF AIR - A MUCH BETTER INSULATOR THAN WATER - NEXT TO THE SKIN
- FLAT SEAMS FOR COMFORT
- ULTRA-LIGHTWEIGHT
- UNISEX
- COMES WITH A LIGHTWEIGHT DRY SACK, IDEAL FOR STORING THE UNDERSUIT AND OTHER ITEMS



TECHNICAL FEATURES

Sizes	XS	S	M	L	XL	XXL
-------	----	---	---	---	----	-----

EXTREME UNDERGARMENT

Code: **412147**

- ENHANCED INSULATION ON CRITICAL AREAS OF THE BODY
- BREATHABLE, FLEECE-LINED, WINDPROOF, WATER-RESISTANT PANELS ON THE CHEST AND ARMS
- EXA-STRETCH ELASTANE FOR ENHANCED STRETCH AND MOVEMENT
- ANTI-ODOR, WASHABLE, BREATHABLE, MOISTURE-WICKING POLYESTER
- HANDWARMER POCKETS FOR COMFORT AND A CONVENIENT, ZIPPED POCKET FOR VALUABLES
- COMES WITH A LIGHTWEIGHT DRY SACK, IDEAL FOR STORING THE UNDERSUIT AND OTHER ITEMS



TECHNICAL FEATURES

Sizes	S	M	L	XL	XXL
-------	---	---	---	----	-----

BASE LAYER

Code: **412173 Top**

Code: **412174 Pants**

- DESIGNED FOR EXTENDED USE IN EXTENDED RANGE DIVING
- WARM, VERY STRETCHY, LIGHTWEIGHT, COMPACT
- KEEPS THE SKIN DRY BY WICKING AWAY PERSPIRATION
- ANTIMICROBIAL AND ANTI-ODOR
- STILL PERFORMS, EVEN IN THE CASE OF SUIT FLOODING



TECHNICAL FEATURES

Sizes	XS	S	M	L	XL	XXL	3XL
-------	----	---	---	---	----	-----	-----

ACTIVE HEATING VEST

Code: 412146

- DOUBLE ZIP FOR COMFORT WHEN SEATED
- SUPPLIED WITH RECHARGEABLE BATTERY AND CHARGER
- ADJUSTABLE HEAT SETTING TEMPERATURE CONTROL
- 2 - 5 HOURS HEATING TIME
- HAND WASHABLE
- CREATED TO BE EVEN LIGHTER AND THINNER FOR DEMANDING DIVERS
- PROVIDES HEAT TO THE BACK KIDNEY AREA AND TO EACH SIDE OF THE CHEST IN ORDER TO GIVE A FEELING OF COMPLETE WARMTH TO THE UPPER BODY

⚠ NOT SUITABLE FOR PEOPLE WITH PACEMAKERS



TECHNICAL FEATURES

Sizes	XS	S	M	L	XL	XXL
Chest Size	34-36"	36-38"	38-40"	40-42"	42-44"	44-46"

BATTERY TECHNICAL FEATURES

Lithium Capacity	2200 mAh
Heating Time	2-5 hours
Weight approx	125g
Dimension	70mm x 50mm x 22mm
Voltage	7.4V
Indicator	Charge level and battery level indicator
Output	EU charger

AHV STANDARD BATTERY

Code: 415780

Battery	Voltage	7.4V
	Capacity	2200 mAh
	Cell	Brand new grade-A Li-ion
Charger	In	AC100V-240V
	Out	DC8.4V 1.2A

ACTIVE HEATING PANTS

Code: 412172

- FRONT 'TROUSER STYLE' ZIP AND ELASTIC WAISTBAND
- SUPPLIED WITH A RECHARGEABLE BATTERY AND CHARGER
- ADJUSTABLE TEMPERATURE CONTROL
- 2 - 5 HOURS HEATING TIME
- HAND WASHABLE
- LIGHT AND THIN FOR DEMANDING DIVERS
- PROVIDES HEAT TO THE BACK ILIAC AREA AND KNEES IN ORDER TO GIVE A FEELING OF COMPLETE WARMTH IN THE LOWER BODY

⚠ NOT SUITABLE FOR PEOPLE WITH PACEMAKERS



TECHNICAL FEATURES

Sizes	S	M	L	XL	XXL
-------	---	---	---	----	-----

BATTERY TECHNICAL FEATURES

Lithium Capacity	2200 mAh
Heating Time	2-5 hours
Weight approx	125g
Dimension	70mm x 50mm x 22mm
Voltage	7.4V
Indicator	Charge level and battery level indicator
Output	EU charger



ACCESSORIES



DCTV CANISTER LIGHT

Code: 415775

- 120 DEGREE NARROW LED DIVING FLASHLIGHT
- 6* CREE XM-L2 (U4), MAX 3400 LUMENS OUTPUT
- 3*26650 RECHARGEABLE LITHIUM BATTERY, MAX RUNTIME REACHES 23H
- REGULATED POWER MAINTAINS CONSTANT CURRENT OUTPUT
- OVER-HEAT PROTECTION FUNCTION - REVERSE POLARITY BATTERY PROTECTION
- MAGNETIC SWITCH
- THREE O-RINGS DESIGNED TO ENSURE WATERPROOF FUNCTION UNDERWATER DOWN TO 200 METERS
- PREMIUM TYPE III MILITARY HARD-ANODIZED AL T6061-T6 AIRCRAFT-GRADE ALUMINUM
- 5MM TOUGHENED GLASS
- SWITCH BUTTON WITH BLOCKING LOCK
- STANDARD ACCESSORIES: SPARE O-RINGS, LANYARD AND PLASTIC BOX
- LARGE BOX FOR MOUNTED LIGHT(S) WITH INNER FOAM PADDING



TECHNICAL FEATURES

ANSI	High	Medium	Low	Very Low	Strobe
Lumen Output	3400lm	2100lm	1000lm	230lm	3400lm
Runtime (3*26650)	1.9hours	3.1hours	6.2hours	23hours	/
Luminous Intensity	130000cd				
Color Temperature	6500 - 7500 Kelvin°				
Beam Distance	72m				
Drop Resistance	1.5m				
Waterproof Grade	IPX-8, underwater 200m				
Dimension	Head: 66 [Dia]*73 [L]mm; Canister: 37 [Dia]*245 [L]mm				
Net Weight	740g (excluding battery)				
Underwater Weight	210g (excluding battery)				

DCTS CANISTER LIGHT

Code: 415776

- 9 DEGREE NARROW LED DIVING FLASHLIGHT
- 3* CREE XM-L2 (U4), MAX 2000 LUMENS OUTPUT
- 2*26650 RECHARGEABLE LITHIUM BATTERY, MAX RUNTIME REACHES 21H
- REGULATED POWER MAINTAINS CONSTANT CURRENT OUTPUT
- OVER-HEAT PROTECTION FUNCTION - REVERSE POLARITY BATTERY PROTECTION
- MAGNETIC SWITCH
- THREE O-RINGS DESIGNED TO ENSURE WATERPROOF FUNCTION UNDERWATER TO 200 METERS
- PREMIUM TYPE III MILITARY HARD-ANODIZED AL T6061-T6 AIRCRAFT-GRADE ALUMINUM
- 5MM TOUGHENED GLASS
- SWITCH BUTTON WITH BLOCKING LOCK
- LARGE BOX FOR MOUNTED LIGHT(S) AND INNER FOAM PADDING
- STANDARD ACCESSORIES: SPARE O-RINGS, LANYARD AND PLASTIC BOX



TECHNICAL FEATURES

ANSI	High	Medium	Low	Very Low	Strobe
Lumen Output	2000lm	1200lm	550lm	135lm	2000lm
Runtime (3*26650)	2.0hours	3.2hours	6.5hours	21hours	/
Luminous Intensity	22000cd				
Color Temperature	6500 - 7500 Kelvin°				
Beam Distance	300m				
Drop Resistance	1.5m				
Waterproof Grade	IPX-8, underwater 200m				
Dimension	Head: 66 [Dia]*73 [L]mm; Canister: 37 [Dia]*175 [L]mm				
Net Weight	700g (excluding battery)				
Underwater Weight	210g (excluding battery)				

BACK UP LIGHT

Code: 415789

- THE LIGHT YOU DEPEND ON IF YOUR PRIMARY FAILS
- TOUGH, VERY COMPACT AND SUPER BRIGHT
- DELRIN BODY AND ALUMINUM HEAD, CAN BE USED TO 100M DEEP
- 8° ANGLE, CONVENIENT FOR LOW VISIBILITY

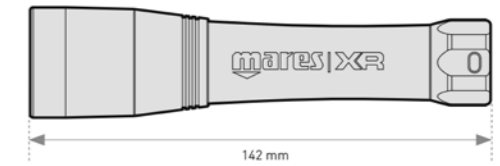

TECHNICAL FEATURES

Battery	1 ICR 18650 (2600mAh)
Led	1 XML2 U2
Beam Angle	8 degrees
Maximum Lumen	850
Beam Distance	220m
1m LUX	12500
Waterproof Grade	IPX-8, underwater 100m
Burn time (min)	2.25 hours
Charge Time	4-5 hours
Dimension	34 x 142mm
Weight	85g

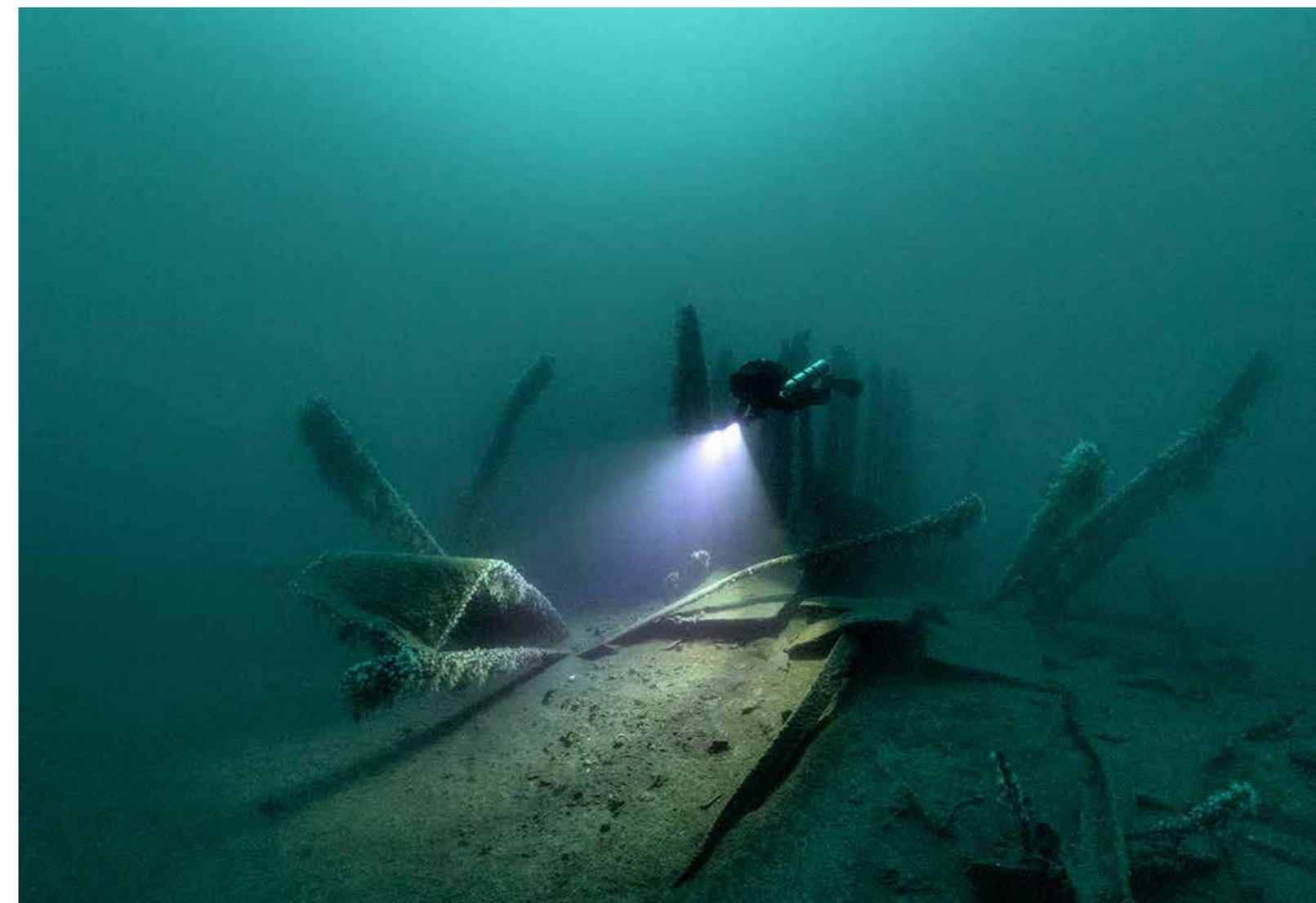

SMBS

Code: **415755 SMB Regular Orange**

Code: **415756 SMB Emergency Yellow**

- WIDTH: 15CM - TOTAL LENGTH: 1.80M (INFLATABLE SECTION: 1.40M) - LIFT: 12KG
- WELDED AND DOUBLE STITCHED
- TRANSPARENT WINDOW AT THE TOP FOR INSERTING WETNOTES, MESSAGES OR GLOW STICKS
- MARKED WITH COAST GUARD APPROVED, SOLAS REFLECTIVE TAPE
- AVAILABLE IN ORANGE (STANDARD) OR YELLOW (EMERGENCY)
- ONE-WAY VALVE FOR LP CONNECTOR OR ONE-BREATH INFLATION
- STAINLESS STEEL D-RING AND BUNGEE ATTACHED
- INFLATE ON THE SURFACE TO ATTRACT ATTENTION OR AT DEPTH TO SEND UP AS A SURFACE MARKER
- FITS IN A THIGH POCKET OR BACKPLATE STORAGE AREA WHEN DEFLATED



SMBS

Code: **415773 SMB Training Orange**

- ONE-BREATH INFLATION TRAINING SMB IN ORANGE
- OVER-PRESSURE VALVE (OPV)
- LENGTH: 1M (3.3FT) - WIDTH: 10CM (3.9IN) - LIFT: 2.7KG (6LB)
- 210D NYLON WITH TPU LAMINATION
- METAL PARTS IN 304 STAINLESS STEEL



LIFT BAG

Code: **415757**

- WELDED AND DOUBLE STITCHED
- 30KG / 80 LB LIFT CAPACITY
- AVAILABLE IN SAFETY-ORANGE COLOR, EASILY SPOTTED BY SURFACE OR AIR TRAFFIC
- ONE-WAY VALVE FOR LP CONNECTOR OR ONE-BREATH INFLATION
- STAINLESS STEEL D-RING ON TOP AND BOTTOM, AND BUNGEE ATTACHED ON THE BOTTOM
- OVER-PRESSURE VALVE (OPV) ALLOWS FOR PRECISE ADJUSTMENT DURING LIFT OPERATIONS WITH A LONG PULLER
- ESSENTIAL FOR A RANGE OF DIVING ACTIVITIES: FROM SALVAGE AND SIGNALING TO REDUNDANT LIFT AND EMERGENCY FLOTATION
- ELIMINATES THE CHANCE THAT GAS WILL ESCAPE FROM YOUR LIFT BAG DURING ASCENT OR WHILE ON THE SURFACE



CAVE/FINGER SS316 COATED SPOOL

Code: **415792 - 15m**

Code: **415792 - 30m**

Code: **415792 - 45m**

Code: **415792 - 60m**

- MARINE GRADE 316 STAINLESS STEEL WITH MOLDED, COATED EDGES
- COMPACT SIZE AND SOFT TOUCH, COMFORTABLE GRIP
- EDELRID™ CORD
- TECHNICAL BUT VERSATILE ENOUGH TO BE USED IN A RANGE OF DIVING APPLICATIONS FROM SMB TO CAVE JUMPS
- UNIQUE FLARED DESIGN ALLOWS FOR EASE OF WINDING WHILST WEARING GLOVES
- LARGE CENTER HOLE FOR USE IN COLD WATER WHILST WEARING GLOVES
- RUGGED CONSTRUCTION. WELDED MARINE GRADE 316 STAINLESS STEEL
- SPOOL IS NOT OVER-WOUND, ENABLING ADDITIONAL LINE TO BE ADDED IF REQUIRED
- INCLUDES 316 STAINLESS STEEL DOUBLE ENDER
- EASY-RELEASE PULL TABS
- HIGH QUALITY, HIGH VISIBILITY LINE FOR LOW LIGHTING CONDITIONS
- COMPLEMENTED BY A RANGE OF LINE MARKERS AND COOKIES



TECHNICAL FEATURES

Sizes	15m / 49ft	30m / 98ft	45m / 148ft	60m / 200ft

MARKERS

- MADE FROM INJECTION MOLDED, DURABLE ABS
- SUPPLIED IN PACKS OF 5
- CORNERS REMOVED FOR EASE OF USE, LINE GUIDING CURVES AND GROOVES, HOLES FOR RING / IDENTIFIER CLIPPING, DEDICATED SURFACE FOR MARKING
- USED FOR ORIENTATION AS A VISUAL AND TACTILE REFERENCE ON A GUIDELINE
- 3 DIFFERENT TYPES: LINE ARROWS TO INDICATE DIRECTION, COOKIES TO DENOTE A JUNCTION, NON-DIRECTIONAL MARKERS REFERENCE A SPECIFIC SPOT

MARKERS

Code: **415761**



COOKIES

Code: **415760**



ARROWS

Code: **415759**



REELS

Code: **415767 - 60m / 200ft - Safety or Back Up**

Code: **415767 - 120m / 400ft - Primary**

- 6061 MARINE GRADE ANODIZED ALUMINUM ALLOY HANDLE
- HARD-COAT FINISHED
- PRECISION-FIT HANDLE - DELRIN FLARES PRECISELY ADJUSTED
- KNURLED 316 MARINE STAINLESS STEEL LOCK-DOWN SCREW
- 316 MARINE STAINLESS STEEL DOUBLE ENDED BOLT SNAP
- WHITE BRAIDED NYLON LINE
- COLD WATER / DRY GLOVES PULLER
- EXCELLENT QUALITY AND OPTIMIZED DESIGN - ENTANGLEMENT FREE



TECHNICAL FEATURES

Sizes	60m / 200ft	120m / 400ft

XRM-STREAM

Code: 411063

- BLACK, FRAMELESS, FOLDABLE, CLASSIC TECHNICAL DIVING MASK
- LARGE, WIDE, FLAT MONO-LENS
- MATT BLACK LOOK
- COMFORTABLE, FITS ALL SMALLER FACE SHAPES
- HIGHLY COMFORTABLE, LARGE, DOUBLE-SEALED BLACK SKIRT
- ARTICULATED, HEAVY-DUTY BUCKLES
- MARESIXR NEOPRENE STRAP
- VERY STRONG AND DURABLE
- WATERTIGHT AT ALL DEPTHS
- FOR ALL EXTENDED TECHNICAL DIVING USES
- ALSO IDEAL AS A BACK-UP MASK



MASK STRAP

Code: 412903

- EASY TO USE
- ADJUSTS TO FIT ALL FACE SIZES AND HOOD THICKNESSES
- DURABLE, GOOD RESISTANCE TO SALT AND SUN



CAVE MASK BLINDER

Code: 412904

- AN IDEAL TOOL FOR CAVE AND TECHNICAL INSTRUCTORS
- BLACKOUT MASK COVER DESIGNED FOR SIMULATING ZERO VISIBILITY TRAINING AND/OR STRESS CONTROL (CAVE AND/OR STAGES)
- CAN BE USED WITH MULTIPLE STUDENTS AND EASILY TRANSFERRED UNDERWATER IN FULL SAFETY



XRM-CLASSIC

Code: 411064

- BLACK, FRAMELESS, FOLDABLE, CLASSIC TECHNICAL DIVING MASK
- EXTRA-LARGE, EXTRA-WIDE, FLAT MONO-LENS
- SHINY BLACK LOOK
- COMFORTABLE, FITS ALL LARGER FACE SHAPES
- HIGHLY COMFORTABLE, LARGE, DOUBLE-SEALED BLACK SKIRT
- ARTICULATED, HEAVY-DUTY BUCKLES
- MARESIXR NEOPRENE STRAP
- VERY STRONG AND DURABLE
- WATERTIGHT AT ALL DEPTHS
- FOR ALL EXTENDED TECHNICAL DIVING USES
- ALSO IDEAL AS A BACK-UP MASK



SPRING STRAP FOR TEK FIN

Code: 415768

- SPRING WITH WRAP AROUND NYLON PULLER & SAFETY CHORD
- THE BEST SOLUTION FOR TECHNICAL AND COLD WATER DIVING
- SOLD AS A PAIR



TECHNICAL FEATURES

Sizes	R	XL	XXL
	31 cm	34 cm	37 cm

POWER PLANA

Code: 410050

- HIGH-QUALITY NATURAL RUBBER WITH REINFORCED RIBS
- HIGH PERFORMING FIN - IDEAL FOR ALL KINDS OF KICKS, PARTICULARLY FROG KICKS
- HIGH DENSITY MATERIAL MAKES THE FIN NEGATIVELY BUOYANT, A DESIRED FEATURE WHEN USING A DRY SUIT AND A TEC RIG WITH STEEL PLATE
- FULL-SHAPE FOOT POCKET
- MATCH STRAP/FIN SIZES:
 - FIN S > STRAP R
 - FIN R > STRAP XL
 - FIN XL > STRAP XXL
 - FIN XXL > STRAP XXL

TECHNICAL FEATURES

Sizes	S	R	XL	XXL
BUOYANCY	NEGATIVE		NEUTRAL	
FITTING	REGULAR			WIDE
WEIGHT (Size R or 42)	0.8 KG		1.3 KG	
MANEUVERABILITY	MEDIUM			HIGH
THRUST/ USE AGAINST CURRENT	LOW PERFORMANCE			HIGH PERFORMANCE
KICKING	FROG		BOTH	
				FLUTTER



BK

SI



RIGID CAP

Code: **415787**

- TOTALLY NEUTRAL IN WATER
- SUPER LIGHT, FAST DRAINAGE FOAM
- ONE SIZE THAT FITS MOST
- ADJUSTABLE SOFT NYLON CHIN STRAP
- QUICK DISCONNECT BUCKLE
- SUITABLE FOR MOUNTING BACKUP LIGHTS, LED PRIMARY LIGHTS OR A GOPRO® CAMERA

⚠ CAUTION: THE RIGID CAP OFFERS NO IMPACT PROTECTION



HAND COMPASS

Code: **414604**

- COMPASS WITH BUNGEE HOLDER AND EXTRA LONG ELASTOMERIC BUNGEE CORDS
- SIDE AND TOP READING
- LUMINESCENT "GLOW IN THE DARK" INTERNAL DIAL
- DUAL ROTATING INDEX MARKS FOR EASIER RECIPROCAL NAVIGATION
- OVERSIZED FOR EXTREME USE (LOW VISIBILITY, CAVE, NIGHT...)



HAND LINE-CUTTER

Code: **415778 B Titanium**

- S/L
- B TITANIUM ALLOY - HRC 51 ± 2 - 3.5 :
- EXCELLENT ABRASION AND CORROSION RESISTANCE
- VELCRO® BRAND FASTENER
- DEDICATED BAG



HAND LINE-CUTTER

Code: **415777 Ceramic**

- S/S
- ULTRA SHARP
- EXCELLENT ABRASION AND CORROSION RESISTANCE
- VELCRO® BRAND FASTENER
- DEDICATED BAG



LIGHTS BRACKETS

Code: **415798 Pair**

- BRACKETS FOR THE XR RIGID CAP
- HOLDS ANY TYPE OF LIGHT, OF ANY DIAMETER
- HOLDS MARES CANISTER LIGHT HEADS



WETNOTES

Code: **415762**

- WATER RESISTANT NOTEBOOK
- IDEAL FOR UNDERWATER COMMUNICATION, FOR DECO STOPS AND FOR MAKING NOTES
- COVER MADE FROM DURABLE 2250D PU COATED BALLISTIC NYLON
- POCKETS ON THE INSIDE AND OUTSIDE
- CONTAINS 23 PAGES OF REUSABLE /REPLACEABLE WATERPROOF PLASTIC FOIL SHEATHS (W/6 TABLES)
- GRAPHITE PENCIL
- ELASTIC BOOKMARK FOR QUICK REFERENCE
- ELASTIC SECURE CLOSURE LOOP
- ELASTIC SHOCKCORD ATTACHMENT FOR BOLT SNAP



EXPEDITION BAG

Code: **415795**

- HOGARTHIAN AND WATERTIGHT WITH DRAINAGE
- LARGE ENOUGH FOR COMPLETE XR GEAR AND LIGHT FOR TRAVEL
- ADJUSTABLE, PADDED REMOVABLE SHOULDER STRAPS
- ULTRALIGHT BUCKLES AND STRONG HANDLES



TECHNICAL FEATURES

Dimensions (LxWxH)	Volume
30x40x70cm	80L

DRY BACKPACK

Code: **415758**

- FULLY WATERPROOF SACK
- REINFORCED PVC WITH HEAT-SEALED STITCHING
- QUICK CLOSURE
- SHOULDER COMFORT PADS WITH CHEST BUCKLE



TECHNICAL FEATURES

Dimensions (LxWxH)	Volume
35x20x60cm	30L

DEAD BOLT SNAP SS316

Code: **415765 - 75mm**

Code: **415765 - 120mm**

- HIGH QUALITY 316 MARINE GRADE STAINLESS STEEL
- CORROSION AND RUST RESISTANT
- SWIVELING BASES MAKING THEM EASY TO USE
- SMALL SNAPS ARE IDEAL FOR ATTACHING ITEMS SUCH AS BACKUP LIGHTS, A LONG REGULATOR HOSE, A CANISTER LIGHT, SPG ETC.
- LARGE SNAPS ARE GREAT FOR COLD WATER USE WHERE THICK GLOVES MAKE DEXTERITY DIFFICULT



TECHNICAL FEATURES

Sizes	75mm	120mm

DOUBLE ENDER SS316

Code: **415766 - 90mm**

Code: **415766 - 100mm**

Code: **415766 - 120mm**

- HIGH QUALITY MARINE GRADE 316 STAINLESS STEEL
- CORROSION AND RUST RESISTANT
- EASY TO USE EVEN WITH DRY GLOVES
- TO CLIP AWAY GEAR INSIDE DRY SUIT POCKETS
- TO TEMPORARILY STOW A CANISTER LIGHT HEAD
- TO ATTACH A PRIMARY REEL, A SPOOL, WET NOTES, A SPARE MASK, ETC.



TECHNICAL FEATURES

Sizes	90mm	100mm	120mm

DEAD BOLT SNAP BLACK CERAMIC

Code: **415793 - 75mm**

Code: **415793 - 120mm**

- HIGH QUALITY MARINE GRADE 316 STAINLESS STEEL WITH BLACK CERAMIC COATING
- CORROSION AND RUST RESISTANT
- SWIVELING BASES MAKING THEM EASY TO USE
- SMALL SNAPS ARE IDEAL FOR ATTACHING ITEMS SUCH AS BACKUP LIGHTS, A LONG REGULATOR HOSE, A CANISTER LIGHT, SPG ETC.
- LARGE SNAPS ARE GREAT FOR COLD WATER USE WHERE THICK GLOVES MAKE DEXTERITY DIFFICULT



TECHNICAL FEATURES

Sizes	75mm	120mm

DOUBLE ENDER BLACK CERAMIC

Code: **415794 - 90mm**

Code: **415794 - 100mm**

Code: **415794 - 120mm**

- HIGH QUALITY MARINE GRADE 316 STAINLESS STEEL WITH BLACK CERAMIC COATING
- CORROSION AND RUST RESISTANT
- EASY TO USE, EVEN WITH DRY GLOVES
- TO CLIP AWAY GEAR INSIDE DRY SUIT POCKETS
- TO TEMPORARILY STOW A CANISTER LIGHT HEAD
- TO ATTACH A PRIMARY REEL, A SPOOL, WET NOTES, A SPARE MASK ETC



TECHNICAL FEATURES

Sizes	90mm	100mm	120mm



20
23

mares
pure passion

PURE PASSION





2023

COMPUTERS



SMART APNEA

Code: 424153



- NEW DISPLAY FRAME
- NEW COLOR OPTIONS: BLACK AND OLIVE-GREEN
- SEGMENTED LCD DISPLAY
- INSTANTANEOUS DEPTH, DIVE TIME, RECOVERY TIME, TEMPERATURE
- DESCENT AND ASCENT RATE
- CUSTOMIZABLE ALARMS (DEPTH, TIME, SPEED, HYDRATION, RECOVERY TIME)
- ONE SECOND SAMPLING RATE
- ADVANCED PERFORMANCE MICROPROCESSOR
- LATEST GENERATION DEPTH SENSOR
- UPDATABLE FIRMWARE AND DATA DOWNLOAD WITH AFTERMARKET DIVE LINK INTERFACE



COLOR VARIATIONS



BKBL BKGR BGBK BKGN

TECHNICAL FEATURES

Battery	Type	CR2430
	Duration	Approx. 200 hours of diving over a 2 year time span
Max displayed depth	150m	
Resolution	Resolution 0.1m until 99.9m - 1m at depth deeper than 100m In ft. it is always 1ft	
Temperature	-10 °C to +50 °C / 14 °F to 122 °F	
Logbook memory	20-30 hours of dive profile at 1-second sampling rate	
Display	Mineral glass - Diagonal 31 mm / 1 1/4 inch	
Clock	Quartz clock, time, date, dive time, displays up to 999 minutes	

DISPLAYS (SCALE 1:1)



Time mode



Surface display



Dive mode



Programmable alarm

BLUELINK PRO

Code: 414317

- TO DOWNLOAD THE LOGBOOK OF A DIVE COMPUTER USING THE BLUETOOTH LOW ENERGY TECHNOLOGY
- REQUIRES THE MARES AAP OR MYSSI APP (ANDROID, IOS)



DIVE LINK 2 USB

Code: 414316

- FOR DOWNLOADING THE DIVE COMPUTER MEMORY TO PC OR MAC
- REQUIRED SOFTWARE: DIVE ORGANIZER (PC)



SMART DISPLAY PROTECTOR

Code: 415173

- PERFECT FIT AND EASE OF INSTALLATION
- AVOIDS SCRATCHES, DIRT AND SAND
- SOFT AND DURABLE
- ULTRA TRANSPARENT
- SOLD IN A PACK OF 2



DIVE ORGANIZER

- FULL-FEATURED LOGBOOK MANAGEMENT SOFTWARE
- ALLOWS UPGRADING OF FIRMWARE ON COMPATIBLE DIVE COMPUTERS
- ALLOWS UPLOADING OF MAPS AND IMAGES TO ICON HD
- FEATURES TISSUE SATURATION GRAPH WITH DETAILED EVOLUTION DURING THE DIVE
- FOR PC ONLY



MISSION DIGITAL CHRONO SF

Code: 424154

- DIGITAL CHRONOGRAPH WITH BACK LIGHT
- DEPTH RATED TO 200M / 660FT
- HIGH-QUALITY SWISS QUARTZ MOVEMENT
- DAILY ALARM AND HOURLY TIME SIGNAL
- COUNTDOWN TIMER
- DIGITAL TIMEZONE AND DATE
- SECOND DIGITAL TIMEZONE
- FLUORESCENT DIGITS
- STAINLESS STEEL
- ADJUSTABLE STRAP



FINS



X-WING FOOT POCKET COLORED NEW

Code: 420931

- NO BLADE SIDE RIBS
- VERY LIGHTWEIGHT - SIZE 42-43 WEIGHS 270G
- NEW SOFTER MATERIAL
- PREFORMED 30° ANGLE
- ERGONOMIC, ULTRA-REACTIVE FOOTPOCKET MADE IN 2 MATERIALS, DESIGNED TO TRANSMIT ENERGY TO THE FIN IN THE MOST EFFECTIVE WAY, OPTIMIZING EFFORT AND IMPROVING PERFORMANCE
- STIFFENED SOLE TO AVOID DEFORMATION OF THE FOOTPOCKET UNDER BLADE LOAD AND ROTATION IN THE LONGITUDINAL AXIS
- DESIGNED TO BE WORN ALSO WITHOUT NEOPRENE SOCKS
- PACK INFO: SOLD SINGLY
- AVAILABLE IN BLUE, OLIVE-GREEN AND PINK

BL



GN



PK



X-WING FOOT POCKET

Code: 420924

- NO BLADE SIDE RIBS
- VERY LIGHTWEIGHT - SIZE 42-43 WEIGHS 270G
- NEW SOFTER MATERIAL
- PREFORMED 30° ANGLE
- ERGONOMIC, ULTRA-REACTIVE FOOTPOCKET MADE IN 2 MATERIALS, DESIGNED TO TRANSMIT ENERGY TO THE FIN IN THE MOST EFFECTIVE WAY, OPTIMIZING EFFORT AND IMPROVING PERFORMANCE
- STIFFENED SOLE TO AVOID DEFORMATION OF THE FOOTPOCKET UNDER BLADE LOAD AND ROTATION IN THE LONGITUDINAL AXIS
- DESIGNED TO BE WORN ALSO WITHOUT NEOPRENE SOCKS
- PACK INFO: SOLD SINGLY

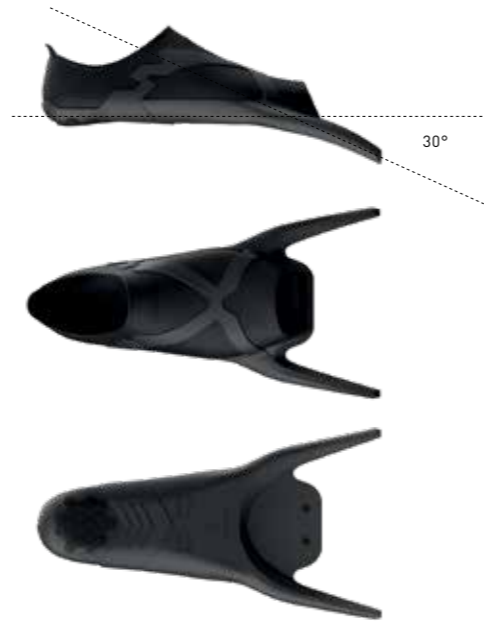

TECHNICAL FEATURES

Sizes	036 - 038 - 040 - 042 - 044 - 046
-------	-----------------------------------

X-WING BLADE FIXING SET

Code: 420925

- PACK INFO: SOLD SINGLY



X-WING FOOT POCKET

BI - MATERIAL

The new variable thickness footpocket provides the best of both worlds. The thicker "X" areas of the footpocket are designed to transmit the energy produced from the leg into the blade with zero dispersion and loss of energy

The footpocket is constructed of a soft material ensuring maximum comfort and fit

The lateral side ribs have been shortened to a minimum, exploiting the best of the elastic and mechanical properties of the blade

Sizing of the foot-pocket is measured on actual barefoot size, including a smaller range for more fitting options.

The new X-WING foot-pocket is among the lightest in the market and designed to exploit our new 30-degree incline blade, resulting in pure comfort and maximum thrust / performance.

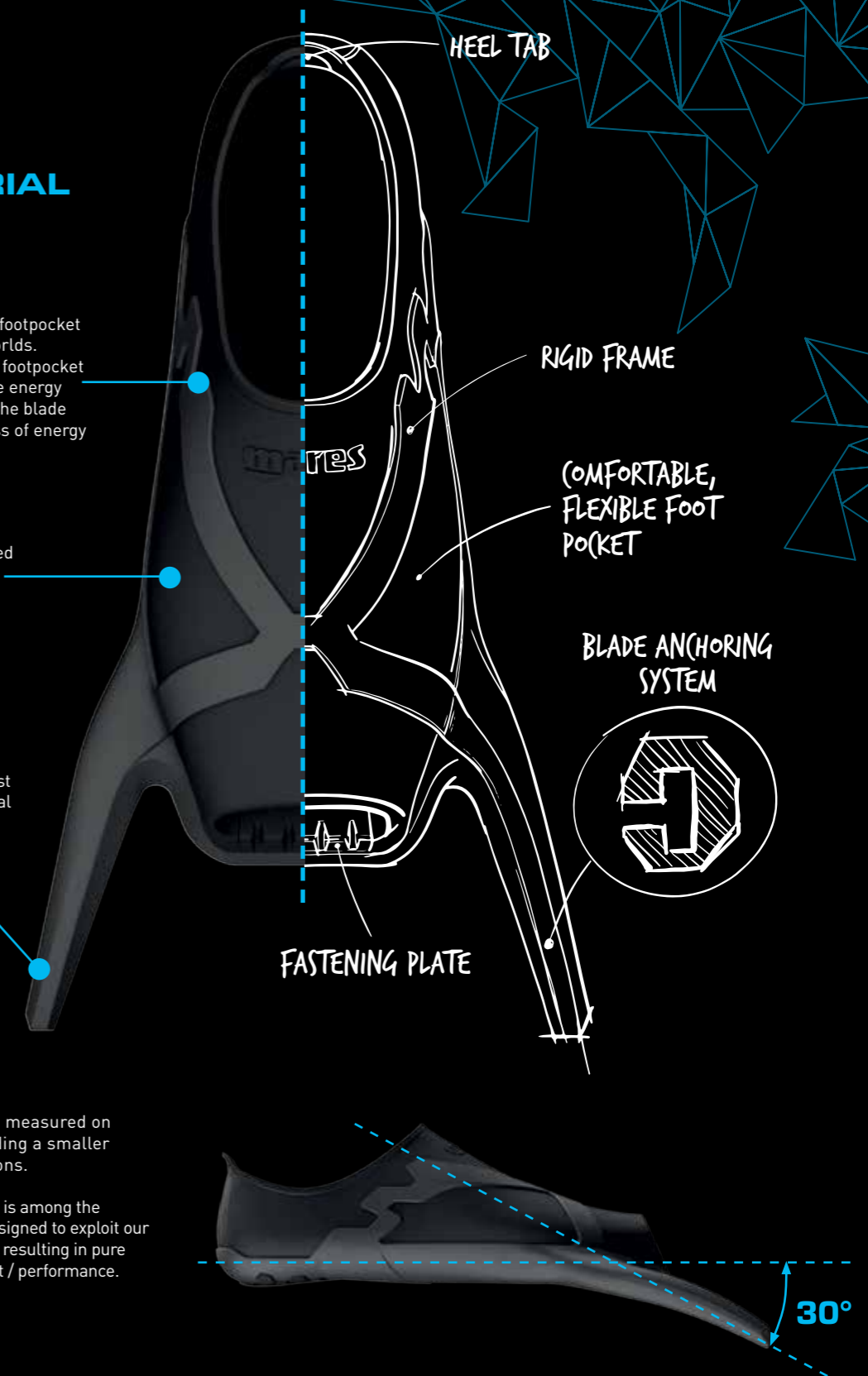

X-WING FIN BLADES

• PACK INFO: SOLD SINGLY

X-WING C-EVO NEW
Code: 420934 SFT/MED



X-WING PRO
Code: 420923



X-WING C-S NEW
Code: 420933 SFT/MED



X-WING PRO BWN
Code: 420929



X-WING APNEA
Code: 420919 SFT/MED



X-WING
Code: 420922



X-WING APNEA S
Code: 420920



X-WING SHORT NEW
Code: 420932



BL

PK

GN

CARBON & FIBERGLASS FINS

100% CARBON

X-WING C-EVO

This fin is specifically designed for freediving and deep fishing. Manufactured in a special aluminum mould capable of achieving exceptional results in terms of durability, responsiveness, and the complete absence of aesthetic defects. The fin blade is subjected to a pressure of approximately 6kg/cm² and warmed with a very rapid increase in temperature, achieving an exceptional outcome. It's made using twelve layers of T700 carbon, with varying textures, lengths, and different types of resin. The inner layers are made with unidirectional weaves to avoid lateral twisting or slipping of the blade. The surface is finished by the same process as used in the latest-generation racing boats. A process where years of research result in an understanding of which surface best eliminates friction and turbulence. The shape of the blade also optimizes thrust by capitalizing on the end section with an elongated profile. The blade has a 30-degree inclination making it a natural extension of the leg. Blades come paired with the new and more comfortable X-WING foot pocket in blue.

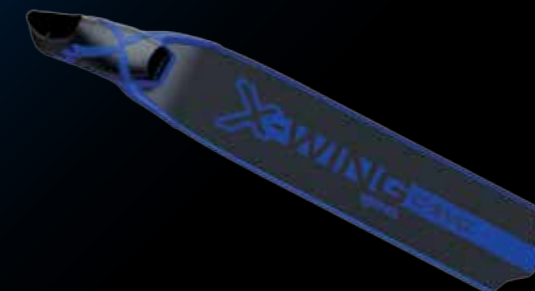

100% CARBON

X-WING C-S

Eleven layers of 100% Carbon with different directions and thickness, pressed into a mould for a responsive and durable product. The fin's moderate size makes it perfect for spearfishers and freedivers looking for greater agility. The blade has a 30-degree inclination, becoming a natural extension of the leg. Paired with the new olive-green X-WING foot pockets for perfect camouflaging.



FIBERGLASS

X-WING APNEA

Composite fin blades are manufactured in a high-pressure press, reaching 15kg/cm². This process allows for precise control of the amount of resin in the product with 100% accuracy and reliability. Each blade is independently milled by CNC and the folding process is completed using an exclusive thermo-forming system with a controlled tempering of the material. This system delivers consistency and unbeatable durability, particularly in the flexion area of the blade. The Fiberglass blades are constructed in a material that is impregnated with a proprietary-formulated resin, making it especially responsive, lightweight, and high performing. The carbon and fiberglass blended blades are compressed in a unique layering process that achieves maximum performance while reducing muscle fatigue over periods of extended use.

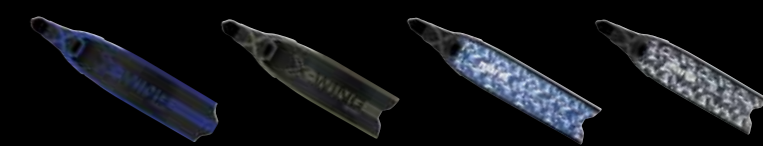

	X-WING C-EVO	X-WING C-S	X-WING APNEA	X-WING APNEA S
CODE	420423	420422	420416	420417
HARDNESS	SOFT	•	•	•
	MEDIUM	•	•	•
LENGHT (mm)	760	620	693	613
DOUBLE WAVE FLEX	•	•	•	•
	100% UNIDIRECTIONAL CARBON	•	•	•
MATERIAL	100% CARBON	•	•	•
	FIBERGLASS	•	•	•
USE	DEEP FREEDIVING & SPEARFISHING	•	•	•
	FREEDIVING & SPEARFISHING	•	•	•

X-WING C-EVO

NEW

Code: 420423 SFT/MED



- BLADE PRODUCED WITH 100% PRE-IMPREGNATED CARBON TO ENSURE HIGH QUALITY AND PROCESS REPEATABILITY
- T700 CARBON WITH FIBERS WOVEN UNIDIRECTIONALLY TO REDUCE SIDE FLECTION
- FIBERS CROSS OVER EACH OTHER FEW TIMES, INCREASING THE RESPONSIVENESS OF THE BLADE
- VARIABLE BLADE THICKNESS AND HIGH-PERFORMING PARABOLIC FLEXION
- THE BLADE IS 190 MM WIDE AND 750 MM LONG
- HIGH-QUALITY MANUFACTURING PROCESS
- VARIABLE SIDE RIBS SUPPORT AND OPTIMIZE CHANNEL THRUST AND FLEX
- AVAILABLE WITH A SOFT OR MEDIUM STRENGTH BLADE DEPENDING ON THE USER'S WEIGHT
- LONG FINS ADAPTED TO A HIGH KICKING FREQUENCY FOR FREEDIVING AND DEEP SPEARFISHING
- 30° BLADE INCLINATION RELATIVE TO THE FOOT POCKET
- THE X-WING FOOT POCKET IS DESIGNED TO BE WORN ALSO WITHOUT A NEOPRENE SOCK
- INTERCHANGEABLE BLADE CONSTRUCTION

TECHNICAL FEATURES

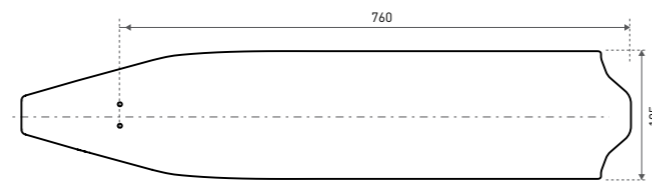

Sizes			Total fin length
EU	UK	USA	
36/37	3/4	4/5	984mm
38/39	5/6	6/7	998mm
40/41	6.5/7.5	7/8	1005mm
42/43	8/9	8.5/9.5	1016mm
44/45	10/10.5	10/11	1038mm
46/47	11.5/12	12/13	1047mm

Blade material	100% Carbon
----------------	-------------

SPARE PARTS

X-Wing Foot Pocket	420924	Page 212
X-Wing Foot Pocket Colored	420931	Page 212
X-Wing Blade Fixing Set	420925	Page 212
X-Wing C-Evo Fin Blade	420934	Page 214

ACCESSORIES

Razor Fin Insole	423943	Page 224
------------------	--------	----------

X-WING C-S

NEW

Code: 420422 SFT/MED



- BLADE PRODUCED WITH 100% PRE-IMPREGNATED CARBON TO ENSURE HIGH QUALITY AND PROCESS REPEATABILITY
- 3K WOVEN CARBON FIBERS WITH HIGH RESISTANCE QUALITIES
- FIBERS CROSS OVER EACH OTHER FEW TIMES, INCREASING THE RESPONSIVENESS OF THE BLADE
- VARIABLE BLADE THICKNESS AND HIGH-PERFORMING PARABOLIC FLEXION
- THE BLADE IS 185 MM WIDE AND 600 MM LONG
- HIGH-QUALITY MANUFACTURING PROCESS
- VARIABLE SIDE RIBS SUPPORT AND OPTIMIZED CHANNEL THRUST AND FLEX
- AVAILABLE WITH A SOFT OR MEDIUM STRENGTH BLADE DEPENDING ON THE USER'S WEIGHT
- MEDIUM LENGTH FINS ADAPTED TO EVERY KICK FREQUENCY
- 30° BLADE INCLINATION RELATIVE TO THE FOOT POCKET
- THE X-WING FOOT POCKET IS DESIGNED TO BE WORN ALSO WITHOUT A NEOPRENE SOCK AND IS MADE IN A NEW, SOFTER MATERIAL
- INTERCHANGEABLE BLADE CONSTRUCTION

TECHNICAL FEATURES

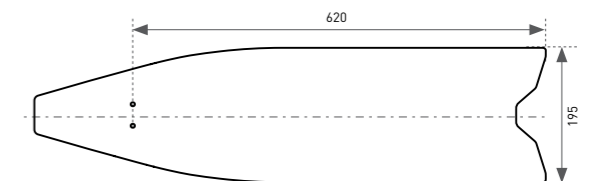

Sizes			Total fin length
EU	UK	USA	
36/37	3/4	4/5	844mm
38/39	5/6	6/7	858mm
40/41	6.5/7.5	7/8	865mm
42/43	8/9	8.5/9.5	876mm
44/45	10/10.5	10/11	898mm
46/47	11.5/12	12/13	907mm

Blade material	100% Carbon
----------------	-------------

SPARE PARTS

X-Wing Foot Pocket	420924	Page 212
X-Wing Foot Pocket Colored	420931	Page 212
X-Wing Blade Fixing Set	420925	Page 212
X-Wing C-S Fin Blade	420933	Page 214

ACCESSORIES

Razor Fin Insole	423943	Page 224
------------------	--------	----------

X-WING APNEA

Code: 420416 SFT/MED



- BLADE PRODUCED WITH PRE-IMPREGNATED FIBERGLASS LAYERS
- VARIABLE BLADE THICKNESS AND HIGH-PERFORMING PARABOLIC FLEXION
- THE BLADE IS 190 MM WIDE AND 693 MM LONG
- HIGH-QUALITY MANUFACTURING PROCESS
- VARIABLE SIDE RIBS SUPPORT AND OPTIMIZE CHANNEL THRUST AND FLEX
- AVAILABLE WITH A SOFT OR MEDIUM STRENGTH BLADE DEPENDING TO THE USER'S WEIGHT
- LONGER FINS, ADAPTED TO MEDIUM KICK FREQUENCY
- BLUE POLYGON BLADE FOR BETTER RECOGNITION IN THE DEEP
- 30° BLADE INCLINATION RELATIVE TO THE FOOT POCKET
- THE X-WING FOOT POCKET IS DESIGNED TO BE WORN ALSO WITHOUT NEOPRENE SOCKS
- INTERCHANGEABLE BLADE CONSTRUCTION



TECHNICAL FEATURES

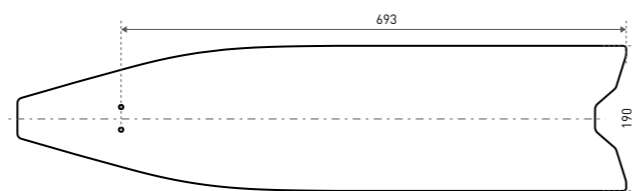

Sizes			Total fin length
EU	UK	USA	
36/37	3/4	4/5	917mm
38/39	5/6	6/7	931mm
40/41	6.5/7.5	7/8	938mm
42/43	8/9	8.5/9.5	952mm
44/45	10/10.5	10/11	971mm
46/47	11.5/12	12/13	980mm

Blade material	Fiberglass
----------------	------------

SPARE PARTS

X-Wing Foot Pocket	420924	Page 212
X-Wing Foot Pocket Colored	420931	Page 212
X-Wing Blade Fixing Set	420925	Page 212
X-Wing Apnea Fin Blade	420919	Page 214

ACCESSORIES

Razor Fin Insole	423943	Page 224
------------------	--------	----------

X-WING APNEA S

Code: 420417



- BLADE PRODUCED WITH PRE-IMPREGNATED FIBERGLASS LAYERS
- VARIABLE BLADE THICKNESS AND HIGH-PERFORMING PARABOLIC FLEXION
- THE BLADE IS 190 MM WIDE AND 613 MM LONG
- HIGH-QUALITY MANUFACTURING PROCESS
- VARIABLE SIDE RIBS SUPPORT AND OPTIMIZE CHANNEL THRUST AND FLEX
- BLACK & WHITE POLYGON BLADE FOR BETTER RECOGNITION IN THE DEEP
- AVAILABLE WITH MEDIUM STRENGTH BLADE
- 30° BLADE INCLINATION RELATIVE TO THE FOOT POCKET
- THE X-WING FOOT POCKET IS DESIGNED TO BE WORN ALSO WITHOUT NEOPRENE SOCKS
- INTERCHANGEABLE BLADE CONSTRUCTION



TECHNICAL FEATURES

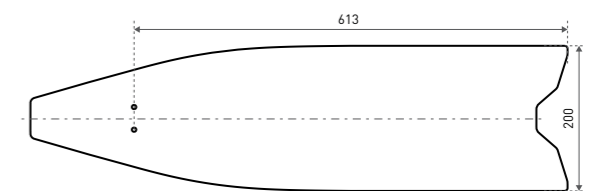

Sizes			Total fin length
EU	UK	USA	
36/37	3/4	4/5	837mm
38/39	5/6	6/7	851mm
40/41	6.5/7.5	7/8	858mm
42/43	8/9	8.5/9.5	872mm
44/45	10/10.5	10/11	891mm
46/47	11.5/12	12/13	900mm

Blade material	Fiberglass
----------------	------------

SPARE PARTS

X-Wing Foot Pocket	420924	Page 212
X-Wing Foot Pocket Colored	420931	Page 212
X-Wing Blade Fixing Set	420925	Page 212
X-Wing Apnea S Fin Blade	420920	Page 214

ACCESSORIES

Razor Fin Insole	423943	Page 224
------------------	--------	----------

X-WING PRO

Code: 420420



- TAPERED HIGH-QUALITY ELASTOMER BLADE FACILITATES EXCELLENT AGILITY AND PERFORMANCE
- PERFORMANCE ENGINEERED FOOT POCKET DELIVERS PERFECT POWER TRANSMISSION FROM FOOT TO BLADE
- V-TIP TO PREVENT SLIPPING FROM SIDE TO SIDE WHILE KICKING
- THE BLADE IS 190 MM WIDE AND 713 MM LONG
- 30° BLADE INCLINATION RELATIVE TO THE FOOT POCKET
- THE X-WING FOOT POCKET IS DESIGNED TO BE WORN ALSO WITHOUT NEOPRENE SOCKS
- INTERCHANGEABLE BLADE CONSTRUCTION

COLOR VARIATIONS



BK BWN

TECHNICAL FEATURES

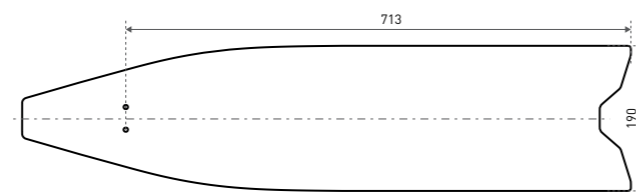

Sizes			Total fin length	Width
EU	UK	USA		
36/37	4/4.5	4.5/5	937mm	190mm
38/39	5.5/6.5	6/7	951mm	190mm
40/41	6.5/7.5	7/8	958mm	190mm
42/43	8/9	8.5/9.5	972mm	190mm
44/45	10/10.5	10/11	991mm	190mm
46/47	11.5/12	12/13	1000mm	190mm

Blade material	Technopolymer
----------------	---------------

SPARE PARTS

X-Wing Foot Pocket	420924	Page 212
X-Wing Foot Pocket Colored	420931	Page 212
X-Wing Blade Fixing Set	420925	Page 212
X-Wing Pro Fin Blade	420923	Page 214

ACCESSORIES

Razor Fin Insole	423943	Page 224
------------------	--------	----------



X-WING

Code: 420419



- TAPERED, HIGH-QUALITY, ELASTOMER BLADE FOR EXCELLENT AGILITY AND PERFORMANCE
- PERFORMANCE ENGINEERED FOOT POCKET DELIVERS PERFECT POWER TRANSMISSION FROM FOOT TO BLADE WITH IN A NEW, SOFTER MATERIAL
- V-TIP TO PREVENT SLIPPING FROM SIDE TO SIDE WHILE KICKING
- THE BLADE IS 190 MM WIDE AND 713 MM LONG
- 30° BLADE INCLINATION RELATIVE TO THE FOOT POCKET
- NEW SUPER SOFT MATERIAL
- THE BEST CHOICE FOR EXTENDED SURFACE SWIMMING AND FREEDIVING
- INTERCHANGEABLE BLADE CONSTRUCTION
- THE X-WING FOOT POCKET IS DESIGNED TO BE WORN ALSO WITHOUT NEOPRENE SOCKS

TECHNICAL FEATURES

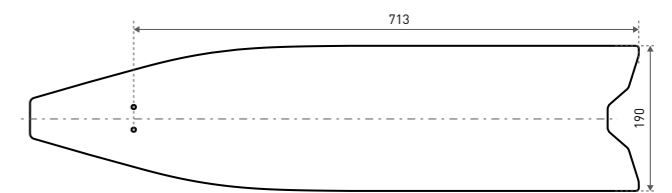

Sizes			Total fin length	Width
EU	UK	USA		
36/37	4/4.5	4.5/5	937mm	190mm
38/39	5.5/6.5	6/7	951mm	190mm
40/41	6.5/7.5	7/8	958mm	190mm
42/43	8/9	8.5/9.5	972mm	190mm
44/45	10/10.5	10/11	991mm	190mm
46/47	11.5/12	12/13	1000mm	190mm

Blade material	Technopolymer
----------------	---------------

SPARE PARTS

X-Wing Foot Pocket	420924	Page 212
X-Wing Foot Pocket Colored	420931	Page 212
X-Wing Blade Fixing Set	420925	Page 212
X-Wing Fin Blade	420922	Page 214

ACCESSORIES

Razor Fin Insole	423943	Page 224
------------------	--------	----------



X-WING SHORT

NEW

Code: 420421



- TAPERED, HIGH-QUALITY ELASTOMER BLADE FOR EXCELLENT AGILITY AND PERFORMANCE
- THE BLADE IS 180 MM WIDE AND 613 MM LONG
- V-TIP BLADE TO PREVENT SLIPPING FROM SIDE TO SIDE WHILE KICKING
- AVAILABLE IN BLUE, OLIVE-GREEN AND PINK
- PINK AND BLUE VERSIONS HAVE A 25% SOFTER BLADE VERSUS X-WING PRO FINS
- THE PINK OR BLUE VERSIONS ARE THE BEST CHOICE FOR EXTENDED SURFACE SWIMMING, FREEDIVING AND LIGHTWEIGHT DIVERS, WHEREAS THE OLIVE-GREEN VERSION IS ADVISED FOR EXTENDED SURFACE SWIMMING AND SPEARFISHING
- 30° BLADE INCLINATION RELATIVE TO THE FOOT POCKET
- INTERCHANGEABLE BLADE CONSTRUCTION
- THE X-WING FOOT POCKET IS DESIGNED TO BE WORN ALSO WITHOUT NEOPRENE SOCKS
- PERFORMANCE ENGINEERED FOOT POCKET DELIVERS PERFECT POWER TRANSMISSION FROM FOOT TO BLADE WITH A NEW, SOFTER MATERIAL



COLOR VARIATIONS



TECHNICAL FEATURES



Sizes			Total fin length	Width
EU	UK	USA		
36/37	4/4.5	4.5/5	837mm	190mm
38/39	5.5/6.5	6/7	851mm	190mm
40/41	6.5/7.5	7/8	858mm	190mm
42/43	8/9	8.5/9.5	869mm	190mm
44/45	10/10.5	10/11	891mm	190mm
46/47	11.5/12	12/13	900mm	190mm

Blade material	Technopolymer
----------------	---------------

SPARE PARTS

X-Wing Foot Pocket	420924	Page 212
X-Wing Foot Pocket Colored	420931	Page 212
X-Wing Blade Fixing Set	420925	Page 212
X-Wing Short Fin Blade	420932	Page 214

ACCESSORIES

Razor Fin Insole	423943	Page 224
------------------	--------	----------

POLYPROPYLENE FINS

Manufactured using a complex injection moulding process that makes it possible to achieve variable-geometric thicknesses, as with carbon and fiberglass blades. This process allows us to make the blade soft and elastic in all the right places. The new range of fins and blades are designed for every use and all types of divers, from the freediver to the spearfisher, while also offering dedicated blades in the women's market

The blades are paired with our new foot pockets in matching colors and new, increasingly soft and comfortable materials. All the blades are at a 30-degree inclination from the foot pocket, transforming the blade into a natural extension of the leg while optimizing output, thereby decreasing fatigue when swimming on the surface.



	X-WING PRO	X-WING PRO	X-WING	X-WING SHORT	X-WING SHORT	X-WING SHORT
CODE	420420 BK	420420 BWN	420419	420421 BL	420421 PK	420421 GN
HARDNESS	MEDIUM	MEDIUM	SOFT	SOFT	SOFT	MEDIUM
BLADE LENGTH	713 mm	713 mm	713 mm	613 mm	613 mm	613 mm
FREEDIVING			•	•	•	
SPEARFISHING	•	•				•

RAZOR FOOT POCKET

Code: **420904**

- DESIGNED TO BE WORN WITH A 3 MM NEOPRENE SOCK
- WEARING THESE FINS BAREFOOT, USE THE NEXT SIZE SMALLER FINS
- PACK INFO: SOLD SINGLY



TECHNICAL FEATURES

Sizes	39/40 - 41/42 - 43/44 - 45/46 - 47/48
-------	---------------------------------------

RAZOR BLADE FIXING SET

Code: **420905 Blade Fixing Set**

Code: **420916 Blade Fixing Set with thick plate**

- BLADE ATTACHMENT KIT FOR YOUR MARES RAZOR/RAZOR PRO FINS
- REPLACE PARTS
- PACK INFO: SOLD SINGLY



RAZOR FIN INSOLE

Code: **423943**

- PREFORMED INSOLE CAN MAKE A RAZOR FOOT POCKET ONE SIZE SMALLER
- USE SCISSORS TO CUT ALONG THE LINES PROVIDED ON THE UNDERSIDE
- THE LENGTH CAN BE ADJUSTED TO THREE DIFFERENT SIZES
- PACK 5 PCS



SIZES

	A	B	C	C
+EU	39/40	41/42	43/44	45/46
=EU	37/38	40/41	42/43	44/45
=UK	4.5/5	6.5/7.5	8/9	10/10.5
=USA	5/6	7/8	8.5/9.5	10/11

RAZOR FIN BLADES

- PACK INFO: SOLD SINGLY

RAZOR POLYGON

Code: **420921**



RAZOR GREY

Code: **420902**



RAZOR PRO BLACK

Code: **420901**



RAZOR POLYGON

Code: **420418**



- BLADE PRODUCED WITH PRE-IMPREGNATED FIBERGLASS LAYERS
- CONSTANT BLADE THICKNESS
- INDIGO BASED CAMOUFLAGE DISGUISES THE SPEARFISHER FOR OPTIMAL FISHING POTENTIAL
- THE BLADE IS 22 CM WIDE AND 59 CM LONG
- HIGH-QUALITY MANUFACTURING PROCESS
- VARIABLE SIDE RIBS SUPPORT AND OPTIMIZE CHANNEL THRUST AND FLEX
- 26° BLADE INCLINATION RELATIVE TO THE FOOT POCKET
- THE RAZOR FOOT POCKET IS DESIGNED TO BE WORN WITH A 3 MM NEOPRENE SOCK
- INTERCHANGEABLE BLADE CONSTRUCTION



TECHNICAL FEATURES

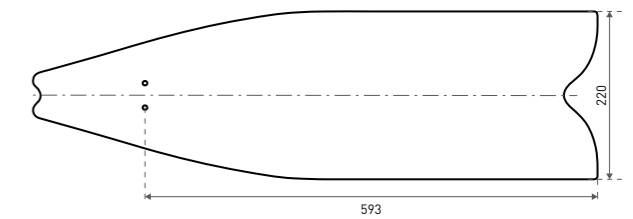

Sizes			Total fin length	Width
EU	UK	USA		
39/40	5.5/6.5	7/8	843mm	220mm
41/42	7.5/8	8.5/9.5	853mm	220mm
43/44	9/10	10/11	873mm	220mm
45/46	10.5/11.5	12/13	883mm	220mm
47/48	12/13	13/14	893mm	220mm

Blade material	Carbon and Fiberglass
----------------	-----------------------

SPARE PARTS

Razor Foot Pocket	420904	Page 224
Razor Polygon Fin Blade	420921	Page 224

ACCESSORIES

Razor Fin Insole	423943	Page 224
------------------	--------	----------

RAZOR PRO

Code: **420401**

- INTERCHANGEABLE BLADE TO MEET DEMANDS IN ALL DIVING CONDITIONS
- TAPERED HIGH-QUALITY ELASTOMER BLADE FACILITATES EXCELLENT AGILITY AND PERFORMANCE
- DESIGNED TO BE WORN WITH A 3MM NEOPRENE SOCK
- PERFORMANCE ENGINEERED FOOT POCKET DELIVERS PERFECT POWER TRANSMISSION FROM FOOT TO BLADE
- V-TIP TO PREVENT SLIPPING FROM SIDE TO SIDE WHILE KICKING



RAZOR

Code: **420402**

- IDEAL CHOICE FOR SHALLOW TO MID-DEPTH DIVING
- 30% SOFTER BLADE VERSUS RAZOR PRO
- BEST CHOICE FOR EXTENDED SURFACE SWIMMING
- DESIGNED TO BE WORN WITH A 3MM NEOPRENE SOCK
- INTERCHANGEABLE BLADE CONSTRUCTION



TECHNICAL FEATURES

Sizes			Total fin length
EU	UK	USA	
39/40	5.5/6.5	7/8	870mm
41/42	7.5/8	8.5/9.5	880mm
43/44	9/10	10/11	900mm
45/46	10.5/11.5	12/13	910mm
47/48	12/13	13/14	920mm

Blade material	Technopolymer
----------------	---------------

SPARE PARTS

Razor Foot Pocket	420904	Page 224
Razor Pro Black Fin Blade	420901	Page 224

ACCESSORIES

Razor Fin Insole	423943	Page 224
------------------	--------	----------

TECHNICAL FEATURES

Sizes			Total fin length
EU	UK	USA	
39/40	5.5/6.5	7/8	870mm
41/42	7.5/8	8.5/9.5	880mm
43/44	9/10	10/11	900mm
45/46	10.5/11.5	12/13	910mm
47/48	12/13	13/14	920mm

Blade material	Technopolymer
----------------	---------------

SPARE PARTS

Razor Foot Pocket	420904	Page 224
Razor Grey Fin Blade	420902	Page 224

ACCESSORIES

Razor Fin Insole	423943	Page 224
------------------	--------	----------

AVANTI QUATTRO POWER

Code: **420404**

- MARES CHANNEL THRUST PATENT
- OPTIMIZED WATER CHANNELING FOR SIGNIFICANT FLOW AND THRUST
- SHORTER BLADE FOR INCREASED CONTROL AND FAST MANEUVERS IN AND UNDER WATER
- ANATOMIC FOOT POCKET WITH REINFORCED HEEL



TECHNICAL FEATURES

Sizes			Total fin length
EU	UK	USA	
40/41	6.5/7.5	7/8	710mm
42/43	8/9	8.5/9.5	725mm
44/45	10/10.5	10/11	755mm
46/47	11.5/12	12/13	765mm

Blade material	EVA
----------------	-----

CONCORDE

Code: **420406**

- IDEAL CHOICE FOR SHALLOW TO MID-DEPTH DIVING
- TECHNOPOLYMER BLADE AND HIGH-PERFORMANCE PARABOLIC FLEXION
- OVER MOLDED FOOT POCKET
- TAPERED LATERAL RIPS FOR PROGRESSIVE BLADE FLEX
- TIP PROFILE PREVENTS SLIPPING FROM SIDE TO SIDE WHILE KICKING



COLOR VARIATIONS



BK GN

TECHNICAL FEATURES

Sizes			Total fin length
EU	UK	USA	
38/39	5/6	6/7	860mm
40/41	6.5/7.5	7/8	874mm
42/43	8/9	8.5/9.5	889mm
44/45	10/10.5	10/11	902mm
46/47	11.5/12	12/13	916mm

Blade material	Technopolymer
----------------	---------------

FINS



				X-Wing C-EVO	X-Wing C-S	X-Wing Apnea	X-Wing Apnea S	X-Wing Pro	X-Wing	X-Wing Short
Code				420423 SFT/MED	420422 SFT/MED	420416 SFT/MED	420417	420420	420419	420421
Color								● BK ● BWN	● BL	● BL ● GN ● PK
Sizes										
EU	UK	USA								
36/37	4/4.5	4.5/5		984mm	844mm	917mm	837mm	937mm	937mm	837mm
38/39	5/6	6/7		998mm	858mm	931mm	851mm	951mm	951mm	851mm
40/41	6.5/7.5	7/8		1005mm	865mm	938mm	858mm	958mm	958mm	858mm
42/43	8/9	8.5/9.5		1016mm	876mm	952mm	872mm	972mm	972mm	869mm
44/45	10/10.5	10/11		1038mm	898mm	971mm	891mm	991mm	991mm	891mm
46/47	11.5/12	12/13		1047mm	907mm	980mm	900mm	1000mm	1000mm	900mm



				Razor Polygon	Razor Pro	Razor	Avanti Quattro Power	Concorde
Code				420418	420401	420402	420404	420406
Color				● CM	● BK	● GR	● CM	● BK ● GN
Sizes								
EU	UK	USA						
38/39	5/6	6/7						860mm
39/40	5.5/6.5	7/8		843mm	870mm	870mm		
40/41	6.5/7.5	7/8					710mm	874mm
41/42	7.5/8	8.5/9.5		853mm	880mm	880mm		
42/43	8/9	8.5/9.5					725mm	889mm
43/44	9/10	10/11		873mm	900mm	900mm		
44/45	10/10.5	10/11					755mm	902mm
45/46	10.5/11.5	12/13		883mm	910mm	910mm		
46/47	11.5/12	12/13					765mm	916mm
47/48	12/13	14/15		893mm	920mm	920mm		



MASKS & SNORKELS



X-TREAM

Code: 421417



- OVER MOLDED FRAME AND ANATOMICAL SKIRT
- MINIMUM DISTANCE BETWEEN THE LENS AND EYES
- ULTRA-MINIMAL INTERNAL VOLUME
- INCREASED FIELD OF VISION
- VERY LIGHTWEIGHT
- ANTI-REFLECTIVE PROPERTIES
- HYDRODYNAMIC PROFILE REDUCES DRAG IN THE WATER
- ERGONOMIC MASK STRAP BUCKLES FOR BETTER HYDRODYNAMICS
- ERGONOMIC MASK STRAP SNORKEL RETAINER FOR EASY DONNING
- EMBOSSED GRIP AREA ON THE NOSE FOR THE PERFECT FIT WITH A NOSE CLIP
- NEW SOFTER SILICONE SKIRT
- NEW LONGER STRAP
- AVAILABLE IN BLACK, GREEN, BLUE, OLIVE-GREEN AND NEON-YELLOW



COLOR VARIATIONS



DETAILS



COLOR MATCHING



VIPER

Code: 421411



- REDUCED DISTANCE FROM LENS TO EYE
- MINIMAL INTERNAL VOLUME
- INCREASED FIELD OF VISION
- ANATOMICAL SKIRT WITHOUT INTERNAL LIP
- VERY LIGHTWEIGHT
- MATTE FINISH FOR ANTI-REFLECTIVE PROPERTIES
- HYDRODYNAMIC PROFILE REDUCING RESISTANCE IN WATER
- ERGONOMIC MASK STRAP BUCKLES FOR EFFORTLESS OPERATION
- THE SILICONE USED IN SKIRT REDUCES FOGGING

SPYDER

Code: 421415



- REDUCED DISTANCE FROM LENS TO EYE
- MINIMAL INTERNAL VOLUME
- INCREASED FIELD OF VISION
- ANATOMICAL SKIRT
- VERY LIGHTWEIGHT
- MATTE FINISH WITH ANTI-REFLECTIVE PROPERTIES
- HYDRODYNAMIC SPYDER PROFILE REDUCES RESISTANCE IN WATER
- ERGONOMIC MASK STRAP BUCKLES FOR EFFORTLESS OPERATION
- THE SILICONE USED IN THE SKIRT REDUCES FOGGING



COLOR VARIATIONS



BK BK BWN BK GNBK BLBL

COLOR VARIATIONS



BK BK BKWGN BKBBL BWKBW PKKBK

STAR LIQUIDSKIN

Code: 421400

- BI-SILICONE SKIRT AND STRAP, EXCLUSIVE MARES LIQUIDSKIN © PATENT
- MINIMAL INTERNAL VOLUME
- REDUCED DISTANCE FROM LENS TO EYE
- INCREASED FIELD OF VISION
- LOW PROFILE BUCKLES POSITIONED ON THE SKIRT



STAR

Code: 421402

- MINIMAL INTERNAL VOLUME
- REDUCED DISTANCE FROM LENS TO EYE
- INCREASED FIELD OF VISION
- LOW PROFILE BUCKLES POSITIONED ON THE SKIRT



COLOR VARIATIONS



BKGR BKAG

COLOR VARIATIONS



BK BK CMBK

ACCESSORIES

Optical lens* Code 411191: from -1,0 to -5,0

ACCESSORIES

Optical lens* Code 411191: from -1,0 to -5,0

*Our optical lenses conform to norm EN 16805. They are not medical devices.

SAMURAI X

Code: 421413



- RESTYLING OF THE HISTORICAL SAMURAI MASK
- REDUCED DISTANCE FROM LENS TO EYES
- MINIMAL INTERNAL VOLUME, UNDER 80 CM3
- WIDE FIELD OF VISION
- NEW LIGHTWEIGHT THIN FRAME
- MATTE FINISH FOR ANTI-REFLECTIVE PROPERTIES
- BUCKLE CONNECTIONS ON THE SKIRT



COLOR VARIATIONS



BKKB BWNBK GNBK

SEALHOUETTE

Code: 421414



- BI-LENS MASK
- SILICONE SKIRT
- REDUCED DISTANCE BETWEEN LENSES AND EYES
- AMPLE FIELD OF VISION
- LIGHTWEIGHT
- SOFT TOUCH SILICONE BUCKLES
- BUCKLES ON SKIRT



COLOR VARIATIONS



BKKB MBKKB MBLBK

DUAL CAMO

Code: 421457

- TUBE IS MADE IN SOFT PVC IN A BLACK CAMOUFLAGE DESIGN
- ANATOMICAL MOUTHPIECE IN HYPOALLERGENIC SILICONE
- DIAMETER AND LENGTH OF TUBE ARE OPTIMIZED FOR EASIER CLEARING AND TO AVOID AIR TURBULENCE
- SPECIAL "D" SHAPED BARREL DESIGN ELIMINATES DISCOMFORT IN THE AREA OF THE TEMPLE



COLOR VARIATIONS



MBKSA MBLSA

DUAL BASIC

Code: 421455

- IDEAL FOR PROLONGED USE
- ANATOMICAL MOUTHPIECE IN HYPOALLERGENIC SILICONE
- DIAMETER AND LENGTH OF TUBE ARE OPTIMIZED FOR EASIER CLEARING AND TO AVOID AIR TURBULENCE
- SPECIAL "D" SHAPED BARREL DESIGN ELIMINATES DISCOMFORT IN THE AREA OF THE TEMPLE



COLOR VARIATIONS



BKSA CLSA

DUAL

Code: 421454

- TUBE IS MADE FROM TWO MATERIALS WITH TWO DIFFERENT SOFTNESS LEVELS
- IDEAL FOR PROLONGED USE
- ANATOMICAL MOUTHPIECE IN HYPOALLERGENIC SILICONE
- DIAMETER AND LENGTH OF TUBE ARE OPTIMIZED FOR EASIER CLEARING AND TO AVOID AIR TURBULENCE
- SPECIAL "D" SHAPED BARREL DESIGN ELIMINATES DISCOMFORT IN THE AREA OF THE TEMPLE



COLOR VARIATIONS



BKSA BWSA GNSA

ELEMENT

Code: 421456

- SOFT TUBE
- DIAMETER AND LENGTH OF TUBE ARE OPTIMIZED FOR NATURAL EFFORTLESS BREATHING
- HYPOALLERGENIC SILICONE MOUTHPIECE



COLOR VARIATIONS



BWSA BKSA



ELEMENT FLOATING

Code: 421458

- FLOATS IN FRESH AND SALT WATER. NEVER LOSE YOUR SNORKEL AGAIN!
- SOFT TUBE
- THE DIAMETER AND LENGTH OF THE SNORKEL ARE OPTIMIZED FOR NATURAL, EFFORTLESS BREATHING
- HYPOALLERGENIC SILICONE MOUTHPIECE



COLOR VARIATIONS



MASKS



Mask	X-Tream	Viper	Spyder	Star Liquidskin	Star	Samurai X	Sealhouette
Code	421417	421411	421415	421400	421402	421413	421414
Colors	<ul style="list-style-type: none"> ● BKBK ● BLWH ● GNBL ● OLBK ● YLBK 	<ul style="list-style-type: none"> ● BKBK ● BLBL ● BWNBK ● GNBK 	<ul style="list-style-type: none"> ● BKBBL ● BKKBK ● BWKBW ● BWKGN ● PKKBK 	<ul style="list-style-type: none"> ● BKAG ● BKGR 	<ul style="list-style-type: none"> ● BKBK ● CMBK 	<ul style="list-style-type: none"> ● BKBK ● BWNBK ● GNBK 	<ul style="list-style-type: none"> ● BKBK ● MBKBK ● MBLBK
Optical lens (optional)				411191 from -1,0 to -5,0	411191 from -1,0 to -5,0		
Streamlined profile		■					
Light weight	■	■	■			■	
Wide field of vision	■	■	■			■	
Internal volume	Minimal	■		■	■	■	■
	Reduced		■				



NEOPRENE



POLYGON

30
Code: 422304 - Jacket
Code: 422305 - Pants
50
Code: 422306 - Jacket
Code: 422307 - Pants
80/65
Code: 422308 - Jacket
Code: 422309 - Pants



- INDIGO POLYGON-BASED CAMOUFLAGE DISGUISES THE SHAPE OF THE SPEARFISHER
 - A PREFORMED CUT ENSURES COMFORT AND EXCELLENT FIT
 - COMPRESSION RESISTANT OPEN CELL MATERIAL WITH EXCELLENT ELASTICITY AND GREAT THERMAL PROPERTIES
 - STITCHED FINISHING AROUND THE FACE, WAIST, WRISTS AND ANKLES
 - ANTI-SLIP CHEST PAD WITH A NEOPRENE "SHOCK ABSORBER" INSIDE
 - NEW CHIN DESIGN
 - BEAVERTAIL WITH VELCRO® BRAND CLOSURE FOR PERFECT ADJUSTMENT
 - ANTI-SLIP KNEE PAD
- 422308 JACKET - DIFFERENTIATED THICKNESS:
8MM ON THE CHEST AND ARMS, 6,5MM ON THE FOREARMS AND HOOD
- 422309 PANTS - 6,5MM



TECHNICAL FEATURES

Thickness	3mm / 5mm / 8-6,5mm				
Fabric Type	Lining Neoprene				
	Open cell				
Sizes	2	3	4	5	6

DETAILS



Three-material waistband to impede water entry Softer border with folded smooth neoprene



COLOR CONTRAST REDUCTION WITH DISTANCE

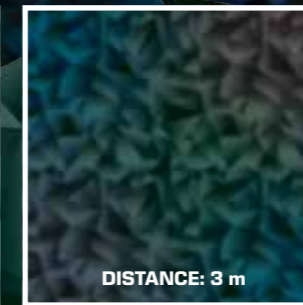
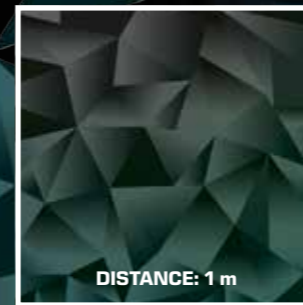

The latest research regarding fish vision shows that they are capable of seeing ultraviolet rays which are invisible to the human eye.

Contrasting colors are also more visible to them. We can obtain the best camouflage by reducing the contrast between colors with a polygonal design that changes with distance, but the most innovative feature of this material is its ultraviolet absorption.

UV light is especially dominant on cloudy or grey days, and makes fluorescent materials brighter.

The least reflective, UV ray absorbing color is INDIGO, the base for our new camouflage.

UV COLOR ABSORPTION AS PERCEIVED BY FISH

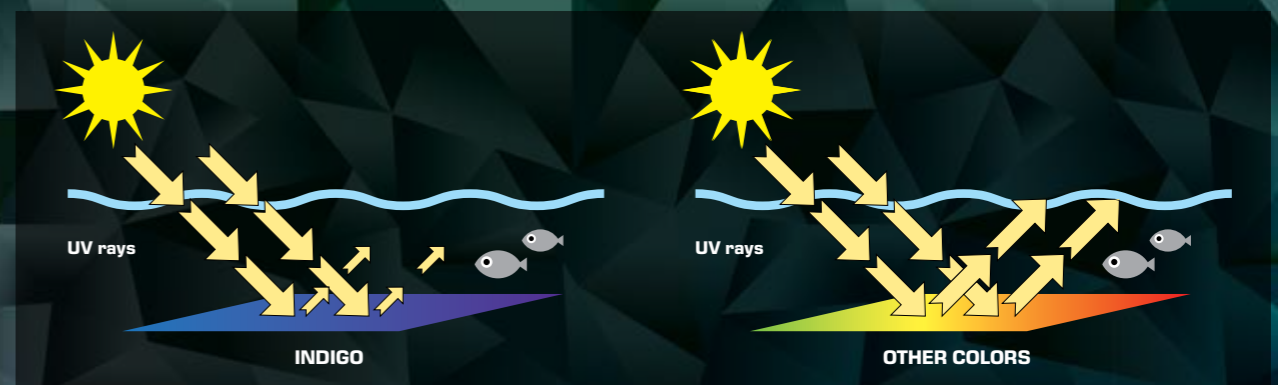

POLYGON BLACK

Code: **422320** - Jacket

Code: **422321** - Pants



- BLACK POLYGON CAMOUFLAGE WITH INDIGO BASED PANELS DISGUISE THE SHAPE OF THE SPEARFISHER
- A PREFORMED CUT ENSURES COMFORT AND AN EXCELLENT FIT
- MADE IN AN OPEN CELL MATERIAL WHICH OFFERS EXCELLENT ELASTICITY, GOOD THERMAL PROPERTIES AND IS COMPRESSION RESISTANT
- ANTI-SLIP CHEST PAD WITH A 6MM NEOPRENE "SHOCK ABSORBER" INSIDE
- NEW CHIN DESIGN
- NEW VELCRO® BRAND CLOSURE FOR PERFECT SUIT ADJUSTMENT



TECHNICAL FEATURES

Thickness	5mm				
	Lining				
Fabric Type	Neoprene				
	Open cell				
Sizes	2	3	4	5	6

DETAILS



Velcro beavertail closure for perfect adjustment

6 mm chest pad

MERGE

Code: **422310** - Jacket

Code: **422311** - Pants



- NEW FAST-DRYING THREE-MATERIAL DESIGN - ELASTIC FABRIC BETWEEN TWO NEOPRENE LAYERS
- SMOOTH / OPEN CELL INNER FABRIC OFFERS HIGH RESISTANCE
- NEOPRENE OFFERS THERMAL, ELASTIC AND HYDRODYNAMIC BENEFITS FOR THE HEAD AND SHOULDERS DURING DIVING AND THE LEGS DURING SURFACE SWIMMING
- A PREFORMED CUT ENSURES COMFORT AND EXCELLENT FIT
- NEW CHIN DESIGN
- NEW MATERIAL DISTRIBUTION FOR EASY BREATHING
- NEW BEAVERTAIL WITH VELCRO® BRAND CLOSURE FOR PERFECT ADJUSTMENT
- BLACK/INDIGO POLYGON-BASED CAMOUFLAGE DISGUISES THE SHAPE OF THE SPEARFISHER
- SOFT NEOPRENE FINISH AROUND THE FACE, WRISTS AND ANKLES
- ANTI-SLIP CHEST PAD WITH A NEOPRENE "SHOCK ABSORBER" AND KNEE PADS
- PANTS WITH THREE-MATERIAL WAISTBAND TO IMPEDE WATER ENTRY
- PANTS WITH AN ULTRA-STRETCH ABDOMINAL BAND TO FACILITATE BREATHING



TECHNICAL FEATURES

Thickness	5mm				
	Smooth				
Fabric Type	Stretch Fabric				
	Open cell				
Sizes	2	3	4	5	6

DETAILS



Velcro beavertail closure for perfect adjustment

Three-material waistband to impede water entry

ILLUSION BWN

- 30**
Code: **422035** - Jacket
Code: **422036** - Pants
- 50**
Code: **422033** - Jacket
Code: **422034** - Pants
- 70**
Code: **422032** - Jacket



- OCEAN FLOOR CAMOUFLAGE PRINTED ON A BEIGE LINING MASKS THE DIVER
- A PREFORMED CUT ENSURES COMFORT AND EXCELLENT FIT
- EXCELLENT ELASTICITY AND COMPRESSION RESISTANCE
- ANTI-SLIP CHEST PAD AND NEOPRENE "SHOCK ABSORBER" INSIDE
- REINFORCED KNEE PADS



ILLUSION

- 30**
Code: **422487** - Jacket
Code: **422488** - Pants
- 50**
Code: **422484** - Jacket
Code: **422485** - Pants
Code: **422486** - Long John



- OCEAN FLOOR CAMOUFLAGE PRINTED ON BEIGE LINING CREATE TOTAL CONCEALMENT FOR THE DIVER
- PREFORMED CUT ENSURES COMFORT AND EXCELLENT FIT
- EXCELLENT ELASTICITY AND COMPRESSION RESISTANCE
- ANTI-SLIP CHEST PAD AND NEOPRENE "SHOCK ABSORBER" INSIDE
- REINFORCED KNEE PADS



TECHNICAL FEATURES

Thickness	3mm / 5mm / 7mm				
	Lining				
Fabric Type	Neoprene				
	Open cell				
Sizes	2	3	4	5	6

TECHNICAL FEATURES

Thickness	3mm / 5mm				
	Lining				
Fabric Type	Neoprene				
	Open cell				
Sizes	2	3	4	5	6

EXPLORER CAMO BLACK

- 30**
Code: **422040** - Jacket
Code: **422041** - Pants
- 50**
Code: **422038** - Jacket
Code: **422039** - Pants
- 70**
Code: **422037** - Jacket



- BLACK CAMOUFLAGE PRINTED ON A GREY LINING HELPS TO DISGUISE THE SPEARFISHER
- A PREFORMED CUT ENSURES COMFORT AND EXCELLENT FIT
- EXCELLENT ELASTICITY AND COMPRESSION RESISTANCE
- ANTI-SLIP CHEST PAD AND NEOPRENE "SHOCK ABSORBER" INSIDE
- REINFORCED KNEE PADS



TECHNICAL FEATURES

Thickness	3mm / 5mm / 7mm				
	Lining				
Fabric Type	Neoprene				
	Open cell				
Sizes	2	3	4	5	6

EXPLORER SPORT

- 30**
Code: **422312** - Jacket
Code: **422313** - Pants
- 50**
Code: **422466** - Jacket
Code: **422467** - Long John



- A PREFORMED CUT ENSURES COMFORT AND EXCELLENT FIT
- ELASTICITY, COMFORTABLE, COMPRESSION RESISTANT AND EASY TO WEAR
- ANTI-SLIP CHEST PAD AND NEOPRENE "SHOCK ABSORBER" INSIDE
- REINFORCED KNEE PADS



TECHNICAL FEATURES

Thickness	5mm / 3mm				
	Lining				
Fabric Type	Neoprene				
	Lining				
Sizes	2	3	4	5	6

PRISM SKIN 5.0

50 MAN

Code: 422322 - Jacket

Code: 422323 - Pants

50 LADY

Code: 422324 - Jacket

Code: 422325 - Pants



- ULTRASTRETCH SMOOTH-SKIN MATERIAL FOR EASY BREATHING
- INSIDE LINING ALLOWS FOR EASY DONNING, PROVIDING EXCELLENT ELASTICITY AND COMPRESSION RESISTANCE
- VERY HYDRODYNAMIC MATERIAL FOR FASTER ASCENT/DESCENT
- A PREFORMED CUT ENSURES COMFORT AND EXCELLENT FIT
- SOFT BORDER HEM AROUND THE FACE, WRISTS AND ANKLES
- NEW MAN PANTS DESIGN FOR EASY BREATHING
- NEW LADY JACKET DESIGN
- NEW CHIN DESIGN
- VELCRO® BRAND CLOSURE FOR PERFECT ADJUSTMENT



TECHNICAL FEATURES

Thickness	5.0 mm					
	Smooth					
Fabric type	Neoprene					
	Colored lining					
Man Sizes		2	3	4	5	6
Lady Sizes	1	2	3	4	5	

DETAILS



Soft seals

Cut dedicated to female freedivers

PRISM SKIN 3.0

30 MAN

Code: 422314 - Jacket

Code: 422315 - Pants

30 LADY

Code: 422318 - Jacket

Code: 422319 - Pants



- ULTRASTRETCH SMOOTH-SKIN MATERIAL FOR EASY BREATHING
- INSIDE LINING ALLOWS FOR EASY DONNING, PROVIDING EXCELLENT ELASTICITY AND COMPRESSION RESISTANCE
- VERY HYDRODYNAMIC MATERIAL FOR FASTER ASCENT/DESCENT
- A PREFORMED CUT ENSURES COMFORT AND EXCELLENT FIT
- SOFT BORDER FINISHING ON FACE, WRISTS AND ANKLES
- NEW MAN PANTS DESIGN FOR EASY BREATHING
- NEW LADY JACKET DESIGN
- NEW CHIN DESIGN
- VELCRO® BRAND CLOSURE FOR PERFECT ADJUSTMENT



TECHNICAL FEATURES

Thickness	3.0 mm					
	Smooth					
Fabric type	Neoprene					
	Colored lining					
Man Sizes		2	3	4	5	6
Lady Sizes	1	2	3	4	5	

DETAILS



New preformed chin

Velcro beavertail closure for perfect adjustment

HORIZON 0.5

Code: 422326



- UNISEX
- MADE IN 0.5MM ULTRASTRETCH POLYURETHANE
- INNER LINING FACILITATES DONNING AND PROVIDES EXCELLENT ELASTICITY
- VERY HYDRODYNAMIC MATERIAL FOR FASTER SWIMMING AND DYN FREEDIVING COMPETITIONS
- A PREFORMED CUT ENSURES COMFORT AND EXCELLENT FIT



TECHNICAL FEATURES

Thickness	0.5 mm					
Fabric type	Polyurethane					
Unisex Sizes	1	2	3	4	5	6

HORIZON 2.0

Code: 422316 - Man

Code: 422317 - Lady



- ULTRA-STRETCH 2MM SMOOTH MATERIAL FOR EASY BREATHING
- INSIDE LINING ALLOWS FOR EASY DONNING, PROVIDING EXCELLENT ELASTICITY AND COMPRESSION RESISTANCE
- VERY HYDRODYNAMIC MATERIAL FOR FASTER SWIMMING
- A PREFORMED CUT ENSURES COMFORT AND EXCELLENT FIT
- NEW WATER-BARRIER NECK DESIGN



TECHNICAL FEATURES

Thickness	2.0 mm					
Fabric type	Smooth					
	Neoprene					
	Black lining					
Man Sizes		2	3	4	5	6
Lady Sizes	1	2	3	4	5	

DETAILS



New water-barrier neck design

Back zip

APNEA INSTINCT

50 MAN

Code: 422459 - Jacket

Code: 422460 - Pants

50 LADY

Code: 422461 - Jacket

Code: 422462 - Pants



- PREFORMED CUT ENSURES COMFORT AND EXCELLENT FIT
- EXCELLENT ELASTICITY, HIGH THERMAL PROPERTIES AND COMPRESSION RESISTANT
- THE 5 mm JACKET UTILIZES 3.5 mm NEOPRENE AT THE WRISTS AND AROUND THE FACE, INCLUDING THE SAME APPLICATION ON THE PANTS AT THE ANKLES AND WAISTBAND
- HIGH-WAISTED PANTS
- RUGGED DOUBLE-LINED BEAVER TAIL WITH QUICK-CONNECT GROMMETS

TECHNICAL FEATURES

Thickness	5mm					
	Lining					
Fabric Type	Neoprene					
	Open cell					
Sizes Man		2	3	4	5	6
Sizes Lady	1	2	3	4	5	



NEOPRENE

	DESCRIPTION	USE	WETSUIT NAME	THICKNESS
LINED/OPEN CELL 	Fit is snug to the skin for greater comfort. Lubricant required for donning.	SPEARFISHING	POLYGON	3 / 5 / 8 -6.5 mm
		SPEARFISHING	POLYGON BLACK	5 mm
		SPEARFISHING	EXPLORER CAMO BLACK	3 / 5 / 7 mm
		SPEARFISHING	ILLUSION BWN	3 / 5 / 7 mm
		SPEARFISHING	ILLUSION	3 / 5 mm
		FREEDIVING	APNEA INSTINCT	5 mm
LINED/LINED 	Exceptionally durable and easy to put on.	SPEARFISHING	EXPLORER SPORT	3 / 5 mm
SMOOTH/LINED 	Quick-Dry exterior, highly elastic and hydrodynamic.	FREEDIVING	PRISM SKIN	3 / 5 mm
		FREEDIVING / POOL	HORIZON	2 mm
POLYURETHANE/LINED 	Extremely hydrodynamic, elastic, and durable.	FREEDIVING / POOL	HORIZON	0.5 mm
TWINPLY 	As durable as nylon lining, but with the advantages of a smooth exterior and open-cell on the skin.	SPEARFISHING	MERGE	5 mm

ADDITIONAL FEATURES

WETSUIT NAME	1 / CLOSURE TYPE	2 / CHEST REINFORCEMENT	3 / SOFT SEALS
POLYGON	VELCRO	YES	YES (5 / 8 -6.5 mm ONLY)
POLYGON BLACK	VELCRO	YES	NO
MERGE	VELCRO	YES	YES
EXPLORER CAMO BLACK	ALAMARO (2)	YES	NO
ILLUSION BWN	ALAMARO (2)	YES	NO
ILLUSION	ALAMARO (2)	YES	NO
EXPLORER SPORT	ALAMARO (1)	YES	NO
APNEA INSTINCT	ALAMARO (1)	NO	YES (FACE ONLY*)
PRISM SKIN	VELCRO	NO	YES (5mm ONLY)
HORIZON	BACK ZIP	NO	NO

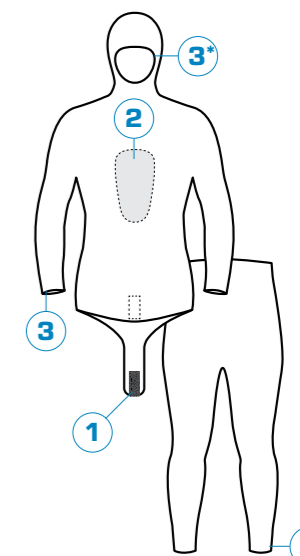

UNDERSUIT

Code: 422424

- LINED NEOPRENE WITH AN OPEN CELL INTERIOR



TECHNICAL FEATURES

Thickness	2mm			
Fabric Type	Neoprene			
Sizes	S	M	L	XL

BACKPACK

Code: 425861 Black

Code: 425863 Illusion



- ANATOMICAL MODULAR BACKPACK
- POCKETS WITH HOLES FOR STANDARD 500G OR 1KG WEIGHTS, MAXIMUM 4KG
- ELASTIC CORD FOR FASTENING TO THE BELT
- QUICK RELEASE SYSTEM



GLOVES FLEX

Code: 422750 3mm

Code: 422759 2mm



- DOUBLE LINED ULTRASTRETCH NEOPRENE
- REINFORCED PALM AND FINGERS



TECHNICAL FEATURES

Thickness	3mm		
Fabric Type	Ultrastretch Neoprene		
Sizes	XS	M	XL

Thickness	2mm		
Sizes	XS/S	M/L	XL/XXL

SOCKS FLEX

Code: 422656 5mm

Code: 422657 3mm

Code: 422658 2mm



- ULTRASTRETCH NEOPRENE
- LINED EXTERIOR / OPEN CELL INTERIOR
- REINFORCED DOUBLE-LINED SOLE



TECHNICAL FEATURES

Thickness	5mm / 3mm / 2mm		
Fabric Type	Ultrastretch Neoprene		
Sizes	XS/S	M/L	XL/XXL

GLOVES SMOOTH SKIN

Code: 422755



- PREFORMED CUT
- NEOPRENE WITH SMOOTH EXTERIOR, LINED INTERIOR
- REINFORCED PALM AND FINGERS



TECHNICAL FEATURES

Thickness	3.5mm			
Fabric Type	Neoprene			
Sizes	S	M	L	XL

SOCKS SMOOTH SKIN

Code: 422654



- SMOOTH OUTSIDE / LINED INSIDE
- PREFORMED CUT
- REINFORCED DOUBLE-LINED SOLE



TECHNICAL FEATURES

Thickness	3mm			
Fabric Type	Neoprene			
Sizes	S	M	L	XL

GLOVES FLEX GOLD

Code: 422762 5mm

Code: 422763 3mm



- ULTRA STRETCH EXTERNAL FABRIC / SPECIAL GOLD TREATMENT ON OPEN CELL INSIDE
- DOUBLE LINED NEOPRENE ON PALM
- REINFORCED FABRIC ON PALM AND FINGERS



TECHNICAL FEATURES

Thickness	5mm / 3mm			
Fabric Type	Ultrastretch Neoprene			
Sizes	S	M	L	XL

SOCKS FLEX GOLD

Code: 422661 5mm

Code: 422660 3mm



- ULTRA STRETCH EXTERNAL FABRIC / SPECIAL GOLD TREATMENT ON OPEN CELL INSIDE
- DOUBLE-LINED SOLE WITH EXTERNAL FABRIC REINFORCEMENT



TECHNICAL FEATURES

Thickness	5mm / 3mm			
Fabric Type	Ultrastretch Neoprene			
Sizes	S	M	L	XL

GLOVES BLACK 25/45/55

Code: 422676



- ULTRASTRETCH FABRIC
- DOUBLE LINED NEOPRENE ON PALM
- SUPER GRIP PALM DESIGN
- DIFFERENTIATED THICKNESSES TO IMPROVE SENSITIVENESS ON THE PALM (2.5MM) AND BACK OF THE HAND (4.5MM)
- 5CM WATER STOP BAND IN 5.5MM NEOPRENE SMOOTHSKIN



TECHNICAL FEATURES

Thickness	2.5 / 4.5 / 5.5mm		
Fabric Type	Ultrastretch Neoprene		
Sizes	XS/S	M	L/XL

GLOVES POLYGON BK 20/35/50

Code: 422675



- ULTRASTRETCH FABRIC
- DOUBLE LINED NEOPRENE ON PALM
- SUPER GRIP PALM DESIGN
- DIFFERENTIATED THICKNESS TO IMPROVE SENSITIVENESS ON THE PALM (2MM) AND BACK OF THE HAND (3.5MM)
- 5CM WATER STOP BAND IN 5.0MM NEOPRENE SMOOTHSKIN
- POLYGON BLACK CAMOUFLAGE DESIGN



TECHNICAL FEATURES

Thickness	2.0 / 3.5 / 5.0mm		
Fabric Type	Ultrastretch Neoprene		
Sizes	XS/S	M	L/XL

SOCKS BLACK 50/60

Code: 422674



- DIFFERENTIATED THICKNESS TO BLOCK WATER FLOW: 5MM LOWER PART, 6MM UPPER PART
- 7CM WATER STOP BAND IN 6MM NEOPRENE SMOOTHSKIN
- ULTRASTRETCH EXTERNAL FABRIC / INTERNAL LINED MATERIAL
- DOUBLE-LINED SOLE WITH EXTERNAL FABRIC REINFORCEMENT



TECHNICAL FEATURES

Thickness	5 mm / 6mm		
Fabric Type	Ultrastretch Neoprene		
Sizes	XS/S	M/L	XL/XXL

SOCKS POLYGON BK 30/50

Code: 422673



- DIFFERENTIATED THICKNESS TO BLOCK WATER FLOW: 3MM LOWER PART, 5MM UPPER PART
- 7CM WATER STOP BAND IN 5MM NEOPRENE SMOOTHSKIN
- POLYGON BLACK CAMOUFLAGE
- ULTRASTRETCH EXTERNAL FABRIC / INTERNAL LINED MATERIAL
- DOUBLE-LINED SOLE WITH EXTERNAL FABRIC REINFORCEMENT



TECHNICAL FEATURES

Thickness	5mm / 3mm		
Fabric Type	Ultrastretch Neoprene		
Sizes	XS/S	M/L	XL/XXL

GLOVES ILLUSION 30

Code: 422760

- NEOPRENE DOUBLE LINING
- REINFORCED PALM AND FINGERS



TECHNICAL FEATURES

Thickness	3mm			
Fabric Type	Neoprene			
Sizes	S	M	L	XL

GLOVES CAMO BLACK 30

Code: 422665

- NEOPRENE DOUBLE LINING
- REINFORCED PALM AND FINGERS



TECHNICAL FEATURES

Thickness	3mm			
Fabric Type	Neoprene			
Sizes	S	M	L	XL

SOCKS ILLUSION BWN 30

Code: 422663

- LINED EXTERIOR / OPEN CELL INTERIOR
- REINFORCED DOUBLE-LINED SOLE



TECHNICAL FEATURES

Thickness	3mm			
Fabric Type	Neoprene			
Sizes	S	M	L	XL

GLOVES ILLUSION BWN 30

Code: 422664

- NEOPRENE DOUBLE LINING
- REINFORCED PALM AND FINGERS



TECHNICAL FEATURES

Thickness	3mm			
Fabric Type	Neoprene			
Sizes	S	M	L	XL

GLOVES AMARA 20

Code: 422752

- NEOPRENE / PALM AND FINGERS IN ULTRA RESISTANT AMARA
- ADJUSTABLE VELCRO



TECHNICAL FEATURES

Thickness	2mm			
Fabric Type	Neoprene			
Sizes	S	M	L	XL

SUITS



Suits	Polygon				Polygon Black		Merge		Explorer Camo Black						
Model	Jacket	Pants	Jacket	Pants	Jacket	Pants	Jacket	Pants	Jacket	Pants	Jacket	Pants	Jacket		
Code	422304	422305	422306	422307	422308	422309	422320	422321	422310	422311	422040	422041	422038	422039	422037
Colors															
Thickness	3 mm		5 mm		8-6,5 mm		5 mm		5 mm		3 mm		5 mm		7 mm
Sizes	2-3-4-5-6				2-3-4-5-6		2-3-4-5-6		2-3-4-5-6						
Maximum Elasticity	■				■		■		■						
Lining / Open cell	■				■		■		■						
3 Materials							■								



Suits	Illusion BWN					Illusion					Explorer Sport			
Model	Jacket	Pants	Jacket	Pants	Jacket	Jacket	Pants	Jacket	Pants	Long John	Jacket	Pants	Jacket	Long John
Code	422035	422036	422033	422034	422032	422487	422488	422484	422485	422486	422312	422313	422466	422467
Colors														
Thickness	3 mm		5 mm		7mm	3 mm		5 mm			3 mm		5 mm	
Sizes	2-3-4-5-6					2-3-4-5-6					2-3-4-5-6			
Maximum Elasticity	■					■					■			
Lining / Open cell	■					■					■			
Lining / Lining											■			

FREEDIVING SUITS



Freediving Suits	Apnea Instinct			Prism Skin				Horizon 0.5	Horizon 2.0						
Model	Man		Lady	Man		Lady		Man	Man	Lady					
Code	Jacket	Pants	Jacket	Pants	Jacket	Pants	Jacket	Pants	Jacket	Pants					
	422459	422460	422461	422462	422314	422315	422318	422319	422322	422323	422324	422325	422326	422316	422317
Colors															
Thickness	5 mm			3 mm				5 mm		0.5 mm	2 mm				
Sizes	2-3-4-5-6		1-2-3-4-5	2-3-4-5-6		1-2-3-4-5		2-3-4-5-6		1-2-3-4-5	1-2-3-4-5				
Maximum Elasticity	■			■				■		■	■				
Lining / Open cell	■										■				
Smooth / Lining				■							■				
Polyurethane								■							

ACCESSORIES



Gloves	Smooth Skin	Flex		Flex Gold		Black 25/45/55	Polygon BK 20/35/50	Illusion 30	Illusion BWN 30	Camo Black 30	Amara 20
Code	422755	422759	422760	422763	422762	422676	422675	422760	422664	422665	422752
Thickness	3,5 mm	2 mm	3 mm	3 mm	5 mm	2.5/4.5/5.5 mm	2/3.5/5 mm	3 mm	3 mm	3 mm	2 mm
Colors											
Sizes	S, M, L, XL	XS/S, M/L, XL/XXL		XS, M, XL		S, M, L, XL	XS/S, M, L/XL	XS/S, M, L/XL	S, M, L, XL	S, M, L, XL	S, M, L, XL



Socks	Smooth Skin 30	Flex			Flex Gold		Black 50/60	Polygon BK 30/50	Illusion BWN 30
Code	422654	422658	422657	422656	422660	422661	422674	422673	422663
Thickness	3 mm	2 mm	3 mm	5 mm	3 mm	5 mm	5/6 mm	3/5 mm	3 mm
Colors									
Sizes	S, M, L, XL	XS/S, M/L, XL/XXL			S, M, L, XL		XS/S, M/L, XL/XXL	XS/S, M/L, XL/XXL	S, M, L, XL



SIZE CHART

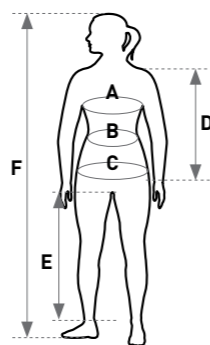
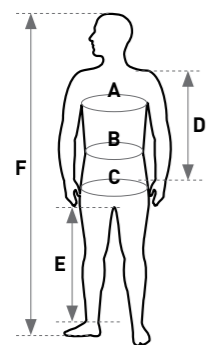

USA	1	2	3	4	5	6
EU	XS	S	M	L	XL	XXL
IT	1	2	3	4	5	6
A	inch 34-36	35-38	37-40	39-41	41-43	42-45
	cm 88/92	91 / 97	95 / 101	99 / 105	103 / 109	107 / 115
B	inch 28-29	30-33	33-35	34-37	36-38	37-41
	cm 72/76	77 / 83	83 / 89	87 / 93	91 / 97	95 / 103
C	inch 33-35	35-38	37-39	39-41	40-43	42-45
	cm 86/90	90 / 96	94 / 100	98 / 104	102 / 108	106 / 114
D	inch 19-20	20-21	21-22	22-23	23-24	24-25
	cm 50/52	52/55	54/57	56/59	58/61	60/63
E	inch 25-27	27-28	28-29	29-30	30-31	31-32
	cm 66/69	68/71	70/73	72/75	74/77	76/79
F	inch 62-64	65-68	67-70	69-71	71-72	72-74
	cm 160/164	166/172	170/176	174/180	178/184	182/188

USA	0	1	2	3	4	5
EU	XXS	XS	S	M	L	XL
IT	0	1	2	3	4	5
A	inch 30-31	33-35	34-37	36-38	37-40	39-41
	cm 77/81	83-89	87-93	91-97	95-101	99-105
B	inch 23-24	26-28	27-30	29-31	30-33	32-34
	cm 59/63	65-71	69-75	73-79	77-83	81-87
C	inch 31-33	34-37	36-38	38-40	39-41	41-43
	cm 80/85	87-93	91-97	95-101	99-105	103-109
D	inch 18-19	19-20	20-21	21-22	22-23	23-24
	cm 47/49	48-51	50-53	52-55	54-57	56-59
E	inch 24-25	25-26	26-27	27-28	28-29	29-30
	cm 62/64	64-67	66-69	68-71	70-73	72-75
F	inch 61-62	61-64	63-66	65-67	66-69	68-70
	cm 156/158	156-162	160-166	164-170	168-174	172-178

PLEASE NOTE: Freediving/Spearfishing wetsuits must fit well. Given the material used to manufacture them, the table is for reference only. We suggest trying the wetsuit at a Mares retailer.



PNEUMATIC GUNS

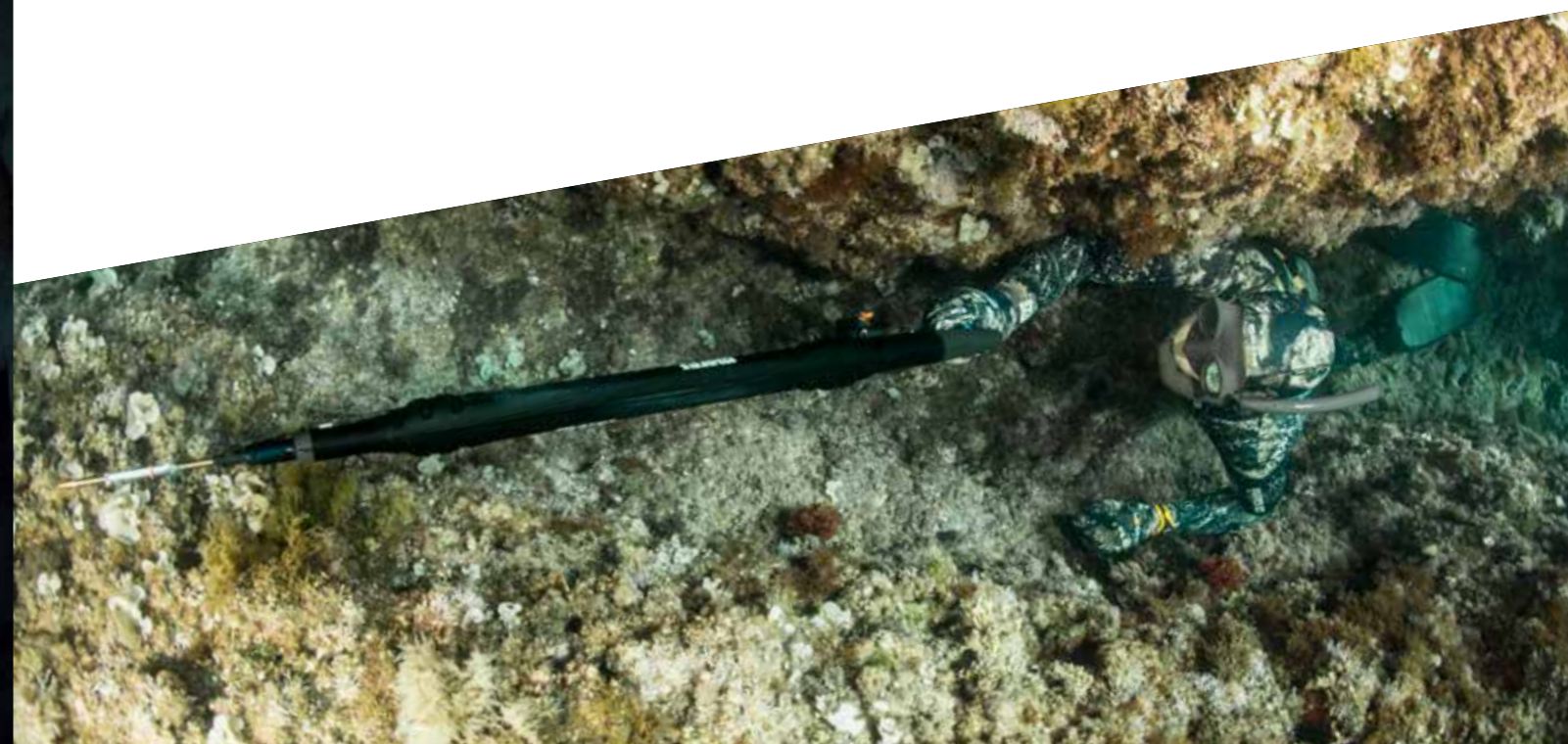

CYRANO 1.1

Code: 423158

120 cm WP - 110 cm WP - 100 cm WP - 90 cm WP - 70 cm WP - 55 cm WP



- 40MM OUTER BARREL
- LIGHTER SINGLE-PIECE HEAD WITH SMALLER CONE
- 11MM INTERNAL BARREL IS SHIFTED UPWARD OFF-AXIS FOR A BETTER LINE OF SIGHT
- STAINLESS STEEL LINE RELEASE AND TRIGGER, BETTER FLUIDITY DURING THE SHOOT
- PISTON EVO, INCREASE IN SPEED, EASY LOADING, BETTER LUBRICATION
- OVERSIZED AIR PASSAGES IN THE INNER BARREL
- ERGONOMIC HANDLE WITH GRIP IN 'CYRANO BLUE' COLOR
- 7MM THREADED SHAFT ON GUN SIZES 55 AND 70
- SHAFT RACE: 7MM SINGLE BARB TAHITIAN SHAFT ON GUN SIZES 90, 100, 110 AND 120
- LIGHTWEIGHT CARRYING BAG INCLUDED



TECHNICAL FEATURES

Internal barrel		13 mm					
Sizes		55WP	70WP	90WP	100WP	110WP	120WP
Shaft Race	Ø mm			7	7	7	7
	cm			97	105	122	132
Threaded Shaft	Ø mm	7	7				
	cm	56,9	67,1				
Operating pressure	BAR	16	20	22	24	24	26
Connecting Piston	Ø mm	1,5 mm					

WP: with power adjusting system

STEN

Code: 413105

70 cm WP - 58 cm WP - 41 cm NP



- 40MM OUTER BARREL
- LOW WEIGHT SINGLE PIECE HEAD
- REINFORCED NOSE CONE
- 8MM THREADED SHAFT
- INCLUDES HOLSTER



TECHNICAL FEATURES

Internal barrel		13 mm		
Sizes		41NP	58WP	70WP
Shaft Race	Ø mm	8	8	8
	cm	36,9	51,9	66,9
Threaded Shaft	Ø mm	8	8	8
	cm	36,9	51,9	66,9
Operating pressure	BAR	13	13	16
Connecting Piston	Ø mm	1,5 mm		

WP: with power adjusting system

JET

Code: 413106

70 cm NP - 58 cm NP - 41 cm NP



- 40MM OUTER BARREL
- LOW WEIGHT SINGLE-PIECE HEAD
- REINFORCED NOSE CONE
- 8MM THREADED SHAFT



TECHNICAL FEATURES

Internal barrel		13 mm		
Sizes		41NP	58NP	70NP
Shaft Race	Ø mm	8	8	8
	cm	36,9	51,9	66,9
Threaded Shaft	Ø mm	8	8	8
	cm	36,9	51,9	66,9
Operating pressure	BAR	13	13	16
Connecting Piston	Ø mm	3 mm		

Model	BARREL PRESSURE BAR / kPa / PSI				
	10 / 1000 / 145	15 / 1500 / 217,5	20 / 2000 / 290	25 / 2500 / 362,5	30 / 3000 / 435
Cyrano 1.1 55	110	170	250	340	440
Cyrano 1.1 70	170	270	390	520	680
Cyrano 1.1 90	200	320	460	620	800
Cyrano 1.1 100	260	420	600	800	1040
Cyrano 1.1 110	300	480	700	950	1200
Cyrano 1.1 120	340	540	800	1100	1360
Sten 41	60	130	170	210	240
Sten 58	100	160	230	310	400
Sten 70	140	220	320	430	560
Jet 41	50	100	150	180	220
Jet 58	70	150	250	380	500
Jet 70	130	190	290	400	720

All Mares pneumatic spearguns are produced and delivered pressurized at manufacturer recommended specs.
 * Number of pumps listed to pressurize pneumatic gun is based upon barrel chamber beginning at empty 0 BAR / PSI.

PNEUMATIC GUNS



Gun	Cyrano 1.1						Sten			Jet			
	423158						413105			413106			
Sizes	55WP	70WP	90WP	100WP	110WP	120WP	41NP	58WP	70WP	41NP	58NP	70NP	
Shaft Race	∅ mm		7	7	7	7	8	8	8	8	8	8	
	cm		97	105	122	132	36,9	51,9	66,9	36,9	51,9	66,9	
Threaded Shaft	∅ mm	7	7				8	8	8	8	8	8	
	cm	56,9	67,1				36,9	51,9	66,9	36,9	51,9	66,9	
Operating pressure	BAR	16	20	22	24	24	26	13	13	16	13	13	
Connecting piston	∅ mm	1,5 mm						1,5 mm			3 mm		
Compact head		■									■		
Internal barrel	mm	11 mm						13 mm			13 mm		
Ergonomic handle		■						■					
Stainless steel side line releaser		■											
Stainless steel trigger		■											
Cone with steel line guide		■						■					
Dedicated case included		■						■					
Manual injector included		■						■			■		



SLING GUNS



STRIKE POLYGON

Code: 423431

115 cm - 100 cm - 90 cm - 75 cm



- THE 28MM DIAMETER CIRCULAR BARREL IS CONSTRUCTED OF ANTI-CORROSIVE EXTRUDED ALUMINUM WITH A LOW FRICTION INTEGRATED SHAFT GUIDE
- OPEN MUZZLE CONFIGURATION WITH A FRICTION REDUCTION SYSTEM BETWEEN THE SLINGS AND THE BARREL
- THE MUZZLE ACCOMMODATES TWO 14MM CIRCULAR SLINGS
- A SIMPLIFIED AND OPEN LINE OF SIGHT INCREASES PRECISION AND INSTINCTIVE SHOOTING
- LINE RETAINERS ON THE MUZZLE AND HANDLE ARE LOW PROFILE WITH A CLEAN, SIMPLE DESIGN
- LINE RELEASE MECHANISM IS CONSTRUCTED IN STAINLESS STEEL AND OPTIMIZED FOR LOADING WITH THICKER BANDS
- TRIGGER IS DESIGNED IN A GEOMETRIC SHAPE FOR DYNAMIC SHOOTING
- LATEX CIRCULAR SLINGS COME IN A NEW INDIGO COLOR, MINIMIZING THE REFLECTION OF UV RAYS VISIBLE TO FISH
- DYNEEMA WISHBONE
- 7MM TAHITIAN SHAFT IN 17-4 PH TEMPERED STEEL
- 80MM HORIZONTAL REEL WITH A MICROMETRIC ADJUSTMENT CLUTCH AND 50 METERS OF 1.7MM DIAMETER LINE
- ERGONOMIC HANDLE IN A NON-SLIP GEOMETRIC SHAPE
- THE ANGLE OF THE HANDLE IN RESPECT TO THE BARREL IS DESIGNED FOR CONTINUITY WITH THE SHOOTERS ARM, ABSORBING RECOIL
- WIDE SHOOTING LINE-RETAINER CAN BE POSITIONED ON EITHER RIGHT OR LEFT SIDE
- RETRACTABLE SLIDING SAFETY MECHANISM
- REEL HOUSING WITH INSERT ACCOMMODATES USE WITH ROLLER MUZZLES
- POLYGON CAMOUFLAGE ON THE BARREL

BARREL SECTION

∅ 6 / 6.25 / 6.5 / 7 mm

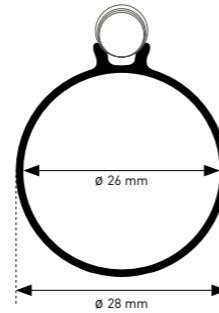

TECHNICAL FEATURES

Barrel	28				
Sizes	75	90	100	115	
Shaft Strike	∅ mm	7	7	7	7
	cm	115	130	140	155
Two S-Power Speed circular slings	∅ mm	14	14	14	14
	cm	50	58	64	72

DETAILS

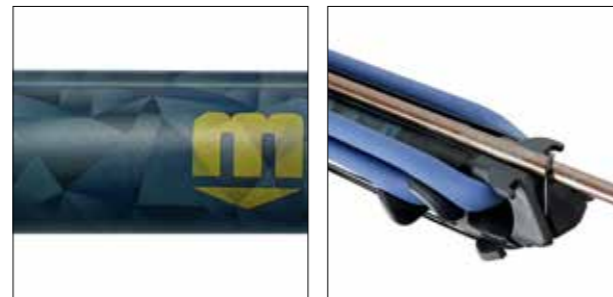

STRIKE GUNS

STRIKE ELEMENT



STRIKE



STRIKE POLYGON



mares
pure passion

STRIKE

Code: 423430

115 cm - 100 cm - 90 cm - 75 cm - 55 cm



- A 28MM DIAMETER CIRCULAR BARREL IS CONSTRUCTED OF ANTI-CORROSIVE EXTRUDED ALUMINUM WITH A LOW FRICTION INTEGRATED SHAFT GUIDE
- OPEN MUZZLE CONFIGURATION WITH A FRICTION REDUCTION SYSTEM BETWEEN THE SLINGS AND THE BARREL. THE MUZZLE ACCOMMODATES ONE OR TWO CIRCULAR SLINGS, RANGING FROM 14MM TO 18MM IN DIAMETER
- SIMPLIFIED AND OPEN LINE OF SIGHT INCREASES PRECISION AND INSTINCTIVE SHOOTING
- LINE RETAINERS ON THE MUZZLE AND HANDLE ARE LOW PROFILE WITH A CLEAN AND SIMPLE DESIGN
- LINE RELEASE MECHANISM IS CONSTRUCTED IN STAINLESS STEEL AND OPTIMIZED FOR LOADING WITH THICKER BANDS
- TRIGGER IS DESIGNED IN A GEOMETRIC SHAPE FOR DYNAMIC SHOOTING
- LATEX CIRCULAR SLINGS COME IN A NEW INDIGO COLOR MINIMIZING REFLECTION OF UV RAYS VISIBLE TO FISH
- DYNEEMA WISHBONE
- 6.5MM TAHITIAN SHAFT IN 17-4 PH TEMPERED STEEL
- 80MM HORIZONTAL REEL WITH A MICROMETRIC ADJUSTMENT CLUTCH AND 50 METERS OF 1.7MM DIAMETER LINE
- ERGONOMIC HANDLE IN A NON-SLIP GEOMETRIC SHAPE. THE ANGLE OF THE HANDLE IN RESPECT TO THE BARREL IS DESIGNED FOR CONTINUITY WITH THE SHOOTERS ARM, ABSORBING RECOIL
- WIDE SHOOTING LINE-RETAINER CAN BE POSITIONED ON EITHER RIGHT OR LEFT SIDE
- RETRACTABLE SLIDING SAFETY MECHANISM
- REEL HOUSING WITH INSERT ACCOMMODATES USE WITH ROLLER MUZZLES

BARREL SECTION

ø 6 / 6.25 / 6.5 / 7 mm

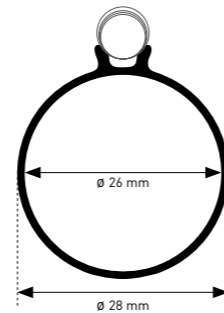

TECHNICAL FEATURES

Barrel	28					
Sizes	55	75	90	100	115	
Shaft Strike	ø mm	6,5	6,5	6,5	6,5	6,5
	cm	95	115	130	140	155
S-Power Speed circular sling	ø mm	17	17	17	-	-
	cm	42	54	63	-	-
Two S-Power Speed circular slings	ø mm	-	-	-	14	14
	cm	-	-	-	64	72

DETAILS



STRIKE ELEMENT

Code: 423432

100 cm - 90 cm - 75 cm - 55 cm

- THE 28MM DIAMETER CIRCULAR BARREL IS CONSTRUCTED OF ANTI-CORROSIVE EXTRUDED ALUMINUM
- OPEN MUZZLE CONFIGURATION WITH A FRICTION REDUCTION SYSTEM BETWEEN THE SLINGS AND THE BARREL
- THE MUZZLE ACCOMMODATES ONE 17MM CIRCULAR SLING
- A SIMPLIFIED AND OPEN LINE OF SIGHT INCREASES PRECISION AND INSTINCTIVE SHOOTING
- LINE RETAINERS ON THE MUZZLE AND HANDLE ARE LOW PROFILE WITH A CLEAN, SIMPLE DESIGN
- LINE RELEASE MECHANISM IS CONSTRUCTED IN STAINLESS STEEL AND OPTIMIZED FOR LOADING WITH THICKER BANDS
- TRIGGER IS DESIGNED IN A GEOMETRIC SHAPE FOR DYNAMIC SHOOTING
- LATEX CIRCULAR SLINGS COME IN A NEW INDIGO COLOR, MINIMIZING THE REFLECTION OF UV RAYS VISIBLE TO FISH
- DYNEEMA WISHBONE
- 6MM TAHITIAN SHAFT IN 17-4 PH TEMPERED STEEL
- ERGONOMIC HANDLE IN A NON-SLIP GEOMETRIC SHAPE. THE ANGLE OF THE HANDLE IN RESPECT TO THE BARREL IS DESIGNED FOR CONTINUITY WITH THE SHOOTERS ARM, ABSORBING RECOIL
- WIDE SHOOTING LINE-RETAINER CAN BE POSITIONED ON EITHER RIGHT OR LEFT SIDE
- RETRACTABLE SLIDING SAFETY MECHANISM
- REEL HOUSING WITH INSERT ACCOMMODATES USE WITH ROLLER MUZZLES

BARREL SECTION

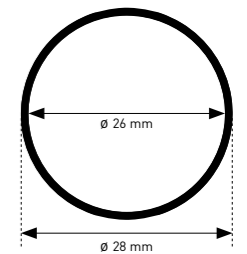

TECHNICAL FEATURES

Barrel	28				
Sizes	55	75	90	100	
Shaft Strike	ø mm	6	6	6	6
	cm	95	115	130	140
S-Power circular sling	ø mm	17	17	17	17
	cm	42	54	63	70

DETAILS



SLING GUN TEST



Mares products undergo rigorous testing to ensure superior quality and performance. Metal objects are inserted into machines simulating various environmental exposures, including cycles of saline mist. This helps us choose the best materials to prevent oxide formation and environmental degradation.



The slings on the gun, including the shooting line, and shaft fins, are put through traction tests using a machine that illustrates power imparted and deformation based upon kilos of thrust delivered.

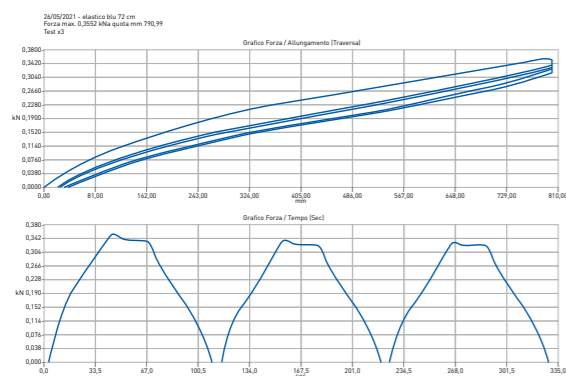

The trigger mechanism for sling spearguns is designed using a test bench device. This machine evaluates kilos of pressure for pulling the trigger in relation to the load on the shaft. This is simulated with different slings loaded simultaneously while giving a precise reading of the trigger performance.

VIPER PRO DS

Code: 423426

110 cm - 100 cm - 90 cm - 75 cm



- RIGID ANODIZED ALUMINUM BARREL WITH UPPER SHAFT GUIDE AND LOWER LINE GUIDE
- OPEN MUZZLE CONFIGURATION, WITH OFF-AXIS HOLES
- HIGHLY SENSITIVE TRIGGER MECHANISM IN A REVERSED POSITION
- STAINLESS STEEL SIDE LINE RELEASE
- STAINLESS STEEL TRIGGER
- PREFORMED HANDLE WITH HIGH-FUNCTIONALITY ANATOMIC GRIP
- VARIABLE DEFORMATION REINFORCED LOADING PAD
- 6.5 MM SINGLE BARB TAHITIAN HARDY SHAFT
- TWO 16 MM S-POWER SPEED CIRCULAR SLINGS WITH DYNEEMA® WISHBONE
- INCLUDES SPIRO VERTICAL REEL

BARREL SECTION

ø 6 / 6.25 / 6.5 / 7 mm

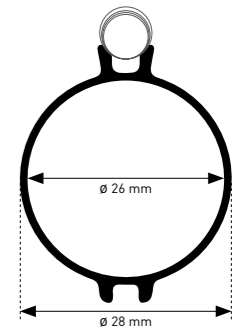

HANDLE VIPER PRO DS

Code : 423994

TECHNICAL FEATURES

Barrel	28				
Sizes	75	90	100	110	
Shaft Strike	ø mm	6.5	6.5	6.5	6.5
	cm	115	130	140	150
Two S-Power Speed circular slings	ø mm	16	16	16	16
	cm	42	50	55	60
Vertical Reel	65	65	87	87	



VIPER PRO

Code: 423416
110 cm - 100 cm - 90cm - 75cm

- RIGID ANODIZED ALUMINUM BARREL WITH UPPER SHAFT GUIDE AND LOWER LINE GUIDE
- OPEN MUZZLE CONFIGURATION, WITH OFF-AXIS HOLES
- HIGHLY SENSITIVE TRIGGER MECHANISM IN A REVERSED POSITION
- STAINLESS STEEL SIDE LINE RELEASE
- DISTANCE BETWEEN TRIGGER AND HANDLE CAN BE CUSTOMIZED
- PREFORMED HANDLE WITH A HIGH-FUNCTIONALITY ANATOMIC GRIP
- VARIABLE DEFORMATION REINFORCED LOADING PAD
- SHAFT SPEED: 6.5MM SINGLE BARB TAHITIAN SHAFT
- 17.5MM S-POWER SPEED CIRCULAR SLING WITH DYNEEMA® WISHBONE
- INCLUDES SPIRO VERTICAL REEL



TECHNICAL FEATURES

Barrel		28			
Sizes		75	90	100	110
Shaft Strike	Ø mm	6.5	6.5	6.5	6.5
	cm	115	130	140	150
S-Power Speed circular sling	Ø mm	17.5	17.5	17.5	17.5
	cm	48	60	65	70
Vertical Reel		65	65	87	87

DETAILS



SNIPER PS

Code: 423424
90 cm - 75 cm - 55 cm - 45 cm

- OUTER BARREL IN ANODIZED ALUMINUM
- COMPACT MUZZLE FOR PAIR OF SLINGS
- SHAFT RELEASE AND LINE RELEASE MADE OUT OF STAINLESS STEEL
- ERGONOMIC HANDLE MIMICS THE SHAPE USED ON VIPER PRO AND CYRANO EVO HF
- SET UP FOR A VERTICAL SPIRO REEL
- SHAFT GALVANIZED STEEL PR80, 6.5MM SINGLE BARB TAHITIAN SHAFT
- PAIR OF 16MM S-POWER SLINGS
- RACE WISHBONE



TECHNICAL FEATURES

Barrel		28			
Sizes		45	55	75	90
Slg shaft zinc coated	Ø mm	6.5	6.5	6.5	6.5
	cm	75	85	115	130
S-Power pair of slings	Ø mm	16	16	16	16
	cm	16	19	22	24

DETAILS

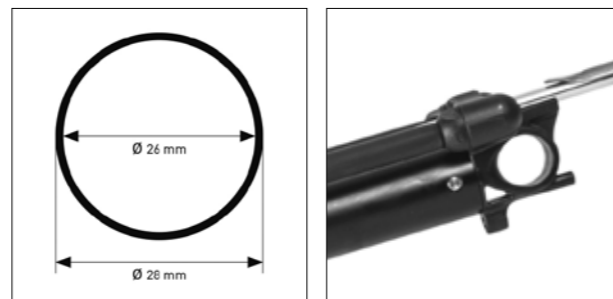

SNIPER

Code: 423421
90 cm - 75 cm - 55 cm - 45 cm

- BARREL IN ANODIZED ALUMINUM
- COMPACT MUZZLE WITH CIRCULAR SLING
- SHAFT RELEASE AND LINE RELEASE MADE OUT OF STAINLESS STEEL
- ERGONOMIC HANDLE MIMICS THE SHAPE USED ON VIPER PRO AND CYRANO EVO HF
- SET UP FOR A VERTICAL SPIRO REEL
- SHAFT GALVANIZED STEEL PR80, 6.5MM SINGLE BARB TAHITIAN SHAFT
- 16MM S-POWER CIRCULAR SLING
- RACE WISHBONE



TECHNICAL FEATURES

Barrel		28			
Sizes		45	55	75	90
Slg shaft zinc coated	Ø mm	6.5	6.5	6.5	6.5
	cm	75	85	115	130
S-Power circular sling	Ø mm	16	16	16	16
	cm	30	34	50	60

DETAILS

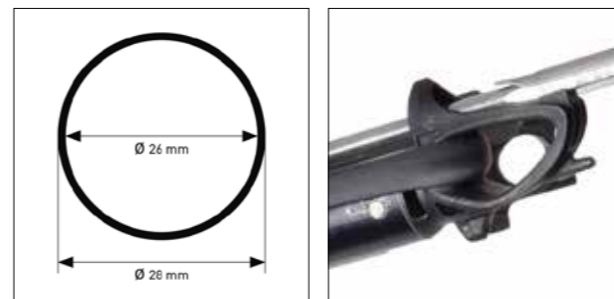

SNIPER ALPHA

Code: 423422
75 cm - 55 cm - 45 cm - 35 cm

- OUTER BARREL IN ANODIZED ALUMINUM
- COMPACT MUZZLE WITH CIRCULAR SLING
- SHAFT RELEASE AND LINE RELEASE MADE OUT OF STAINLESS STEEL
- ERGONOMIC HANDLE MIMICS THE SHAPE USED ON VIPER PRO AND CYRANO EVO HF
- SET UP FOR A VERTICAL SPIRO REEL
- SHAFT GALVANIZED STEEL PR80, 7MM THREADED
- SINGLE -BARB BULLET SPEAR TIP
- 14MM S-POWER CIRCULAR SLING
- RACE WISHBONE



TECHNICAL FEATURES

Barrel		25			
Sizes		35	45	55	75
Slg thread shaft zinc coated	Ø mm	7	7	7	7
	cm	58	68	78	98
S-Power circular sling	Ø mm	14	14	14	14
	cm	28	30	34	50

DETAILS

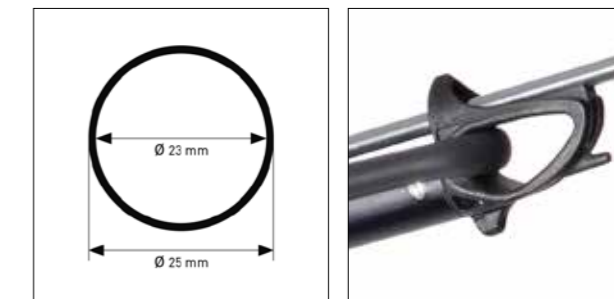



HAND SPEAR FIBER

Code: 423268

- HAND SPEAR MADE IN FIBERGLASS
- 2 PIECES
- REPLACEABLE STEEL BARB
- REPLACEABLE SLING
- CAN BE REDUCED TO HALF ITS LENGTH FOR A SHORTER SPEAR

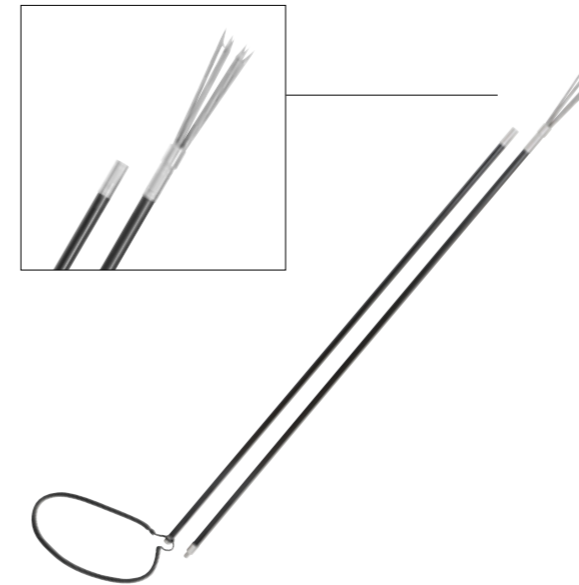

HAND SPEAR HERO

Code: 423269

- HAND SPEAR MADE IN ANODIZED ALUMINIUM
- 2 PIECES
- REPLACEABLE STEEL BARB
- REPLACEABLE SLING

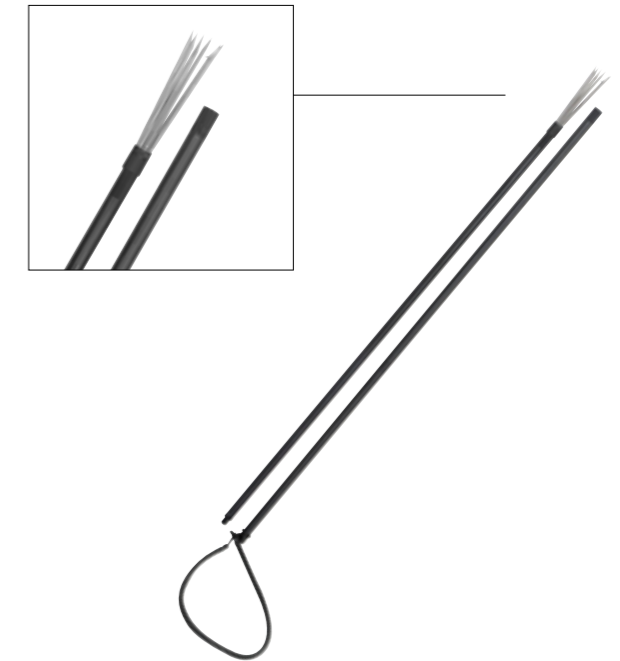

BARB FIBER

NEW

Code: 423732

- A REPLACEMENT BARB FOR THE FIBER HAND SPEAR



SLING HAND SPEAR

NEW

Code: 423848

- A REPLACEMENT SLING FOR THE FIBER AND HERO HAND SPEARS



BARB HERO

NEW

Code: 423731

- A REPLACEMENT BARB FOR THE HERO HAND SPEAR



SLING GUNS



	Strike Polygon				Strike					Strike Element				Viper Pro DS					Viper Pro				Sniper PS				Sniper				Sniper Alpha			
Code	423431				423430					423432				423426					423416				423424				423421				423422			
Sizes	75	90	100	115	55	75	90	100	115	55	75	90	100	75	90	100	110	75	90	100	110	45	55	75	90	45	55	75	90	35	45	55	75	
Barrel	28				28					28				28					28				28				25							
Shaft Strike	■				■					■				■					■				■				■							
Shaft Zinc Coated																																		
Shaft dimensions	∅ mm	7	7	7	7	6.5	6.5	6.5	6.5	6.5	6	6	6	6	6.5	6.5	6.5	6.5	6.5	6.5	6.5	6.5	6.5	6.5	6.5	6.5	6.5	6.5	6.5	6.5	7	7	7	7
	cm	115	130	140	155	95	115	130	140	155	95	115	130	140	115	130	140	150	115	130	140	150	85	95	115	130	75	85	115	130	58	68	78	98
S-Power circular sling										■													■				■							
S-Power pair of slings																			■															
S-Power Speed circular sling					■														■															
Two S-Power Speed circular slings	■				■									■																				
Sling	∅ mm	14	14	14	14	17	17	17	14	14	17	17	17	17	16	16	16	16	17.5	17.5	17.5	17.5	16	16	16	16	16	16	16	16	14	14	14	14
	cm	50	58	64	72	42	54	63	64	72	42	54	63	70	42	50	55	60	48	60	65	70	16	19	22	24	30	34	50	60	28	30	34	50
Reel	■				■									■					■															



Scan the QR code and check out this short video on how to set up your Mares sling gun

Scan here to find out how to load a double sling on your Mares sling gun

	STRIKE POLYGON				STRIKE		VIPER PRO DS				
Sizes	75	90	100	115	100	115	75	90	100	110	
Two S-Power Speed circular slings	∅ mm	14	14	14	14	14	14	16	16	16	16
	cm	50	58	64	72	64	72	42	50	55	60

ACCESSORIES



ASCENT DRY DUFFLE

Code: 425566



- WATERPROOF DUFFLE WITH WHEELS FOR EASY TRANSPORT
- FOLDING CLOSURE
- ERGONOMIC SHOULDER STRAPS TO CARRY IT AS A BACKPACK
- INNER WEIGHT RETAINER STRAPS WITH VELCRO® BRAND FASTENERS
- LARGE EXTERNAL WATERPROOF POCKET



DETAILS



Wheels for easy transport



Folding closure

TECHNICAL FEATURES

Dimensions (LxWxH)	Unit Net Weight	Volume
100x33x65 cm	2,3 kg	140 L

ASCENT DRY TITAN

Code: 425571



- SPACIOUS 840 DENIER TARPULIN BAG THAT CAN CARRY 100KG
- HEAT SEALED BAG WITH NO STITCHING
- ADJUSTABLE HANDLES ARE ATTACHED BY SNAP HOOKS TO WELDED BASE PLATES
- SIDE DRAIN VALVE



DETAILS



Side drain valve



Ergonomic shoulder strap

TECHNICAL FEATURES

Dimensions (LxWxH)	Unit Net Weight	Volume
90x46x35 cm	1,95 kg	144 L

ASCENT DRY BACKPACK

Code: 425565



- WATERPROOF AND DURABLE BACKPACK
- ADJUSTABLE, ERGONOMIC SHOULDER STRAP
- INNOVATIVE REAR ZIP
- WATERPROOF KEY POCKET
- EXTERNAL DOCUMENT POUCH
- SIDE GUN RETAINER
- SIDE FIN HOLDER



DETAILS



Waterproof wetsuit compart



Side gun retainer

TECHNICAL FEATURES

Dimensions (LxWxH)	Unit Net Weight	Volume
35x30x90 cm	1,6 kg	75 L

ASCENT DRY FIN BAG

Code: 425568



- WATERPROOF WETSUIT COMPARTMENT
- ERGONOMIC SHOULDER STRAPS
- WATERPROOF KEY HOLDER
- BOTTLE HOLDER
- FITS VERY LONG FIN, A WETSUIT, MASK, SPEARGUN AND ALL YOU NEED FOR EASY TRANSPORTATION



DETAILS



Ergonomic shoulder straps



External pocket

TECHNICAL FEATURES

Dimensions (LxWxH)	Unit Net Weight
30x28x120 cm	1,6 kg

ASCENT LONG FIN BAG

Code: 425569



- FITS 2 LONG PAIRS OF FINS AND MASKS
- EXTERNAL DOCUMENT POUCH
- ADJUSTABLE SHOULDER STRAP



TECHNICAL FEATURES

Dimensions (LxWxH)	Unit Net Weight	Capacity
20x22x110 cm	800gr	2 pair of fins

ASCENT DRY GUN BAG

Code: 425567



- WATERPROOF BAG
- GUN RETAINER WITH VELCRO® BRAND FASTENERS INSIDE
- FITS UP TO 6 SPEARGUNS
- LARGE EXTERNAL WATERPROOF MASK/DOCUMENT POCKET



TECHNICAL FEATURES

Dimensions (DxH)	Unit Net Weight	Capacity
20x180 cm	1,2 kg	6 guns

ATTACK MONOFIN

Code: 425563



- A BAG FOR TRANSPORTING AND PROTECTING THE RACE MONOFIN
- HORIZONTAL ZIP TO ACCESS THE FRONT POCKET
- ADJUSTABLE SHOULDER STRAP AND HANDLE ON SIDE



TECHNICAL FEATURES

Dimensions (LxWxH)	Unit Net Weight	Volume
77 x 68.5 x 19cm	1kg	100.2l

ATTACK DRY BAG

Code: 425557

- HANDY DRY BAG WITH SHOULDER STRAP
- IDEAL FOR HOLDING WET EQUIPMENT OR CLOTHING YOU WANT TO PROTECT FROM THE WATER
- DIMENSIONS: 75 X 58CM (40 LITERS)



TECHNICAL FEATURES

Dimensions (LxWxH)	Unit Net Weight	Volume
75 x 58cm	0.5kg	40l

ATTACK MESH

Code: 425554 Attack Mesh 700

Code: 425555 Attack Mesh 450

- STURDY WOVEN MESH BAG
- STRAP CLOSURE



TECHNICAL FEATURES

Dimensions (LxH) Attack Mesh 700
45x66 cm
Dimensions (LxH) Attack Mesh 450
35x40 cm

ARGO

Code: 425615

- COMPACT KNIFE WITH ERGONOMIC HANDLE
- 3 MM STAINLESS STEEL BLADE, LENGTH 72MM
- MICRO SERRATION TO GUARANTEE EXCELLENT CUTTING POWER
- THE QUICK-RELEASE SYSTEM MEANS YOU CAN USE IT QUICKLY
- CAN BE STRAPPED ON THE ARM, CALF OR BELT
- TWO ADJUSTABLE VELCRO® BRAND FASTENERS



ARGO TITANIUM

Code: 425616

- COMPACT KNIFE WITH ERGONOMIC HANDLE
- 3MM TITANIUM BLADE, LENGTH 72MM
- MICRO-SERRATION TO GUARANTEE EXCELLENT CUTTING POWER
- THE QUICK-RELEASE SYSTEM MEANS YOU CAN USE IT QUICKLY
- CAN BE STRAPPED ON THE ARM, CALF OR BELT
- TWO ADJUSTABLE VELCRO® BRAND FASTENERS



IAGO

Code: 425614

- KNIFE WITH ERGONOMIC HANDLE
- 4MM 420A STAINLESS STEEL BLADE, PVD-TREATED
- LENGTH OF BLADE: 98MM
- MICRO-SERRATION ALONG THE ENTIRE BLADE, EXCELLENT CUTTING POWER
- BLADE WITH HOLE FOR FREEING SHAFTS STUCK IN THE ROCKS
- THE QUICK-RELEASE SYSTEM MEANS YOU CAN USE IT QUICKLY
- CAN BE STRAPPED ON THE ARM, CALF OR BELT
- TWO STRAPS, QUICK-RELEASE BUCKLES



SNAKE 2.1

Code: **425617**

- STAINLESS STEEL BLADE
- LENGTH OF BLADE: 134 MM
- ONE CUTTING EDGE AND ONE MICRO-SERRATED SHEARING EDGE
- HOLE FOR FREEING SHAFTS STUCK IN ROCKS AND A SHAFT RECTIFIER
- SOFT, ANTI-SLIP HANDLE
- ANTI-CORROSION SYSTEM WITH ANODE IN THE HANDLE
- SEMI-RIGID SCABBARD THAT CAN BE FASTENED TO THE LEG OR A BELT
- TWO STRAPS, QUICK-RELEASE BUCKLES



HERO POLYGON

Code: **425618**

- COMPACT KNIFE, TOTAL LENGTH: 17.5CM
- STAINLESS STEEL BLADE
- LENGTH OF BLADE: 7CM
- ONE CUTTING EDGE AND ONE MICRO-SERRATED SHEARING EDGE
- ERGONOMIC HANDLE WITH ANTI-LOSS SYSTEM
- EASY TO USE WITH GLOVES
- HOLE FOR FREEING SHAFTS STUCK IN ROCKS
- STURDY CORDURA SHEATH
- CAN BE STRAPPED ON THE BELT



HERO POLYGON SHORT

Code: **425619**

- ULTRA-COMPACT KNIFE, TOTAL LENGTH: 13CM
- STAINLESS STEEL BLADE
- LENGTH OF BLADE: 7CM
- ONE CUTTING EDGE AND ONE MICRO-SERRATED SHEARING EDGE
- ERGONOMIC, ONE-FINGER HANDLE WITH ANTI-LOSS SYSTEM
- EASY TO USE WITH GLOVES
- HOLE FOR FREEING SHAFTS STUCK IN ROCKS
- STURDY CORDURA SHEATH
- DESIGNED TO BE ATTACHED TO THE ARM OR CALF
- TWO ADJUSTABLE VELCRO® BRAND FASTENERS



FISH STRINGER

Code: **423823**

- A SINGLE LINE WITH A PIN FOR SECURING YOUR SPEARFISHING CATCHES



FISH STRINGER KIT

Code: **423929**

- THIS KIT CONSISTS OF A PIN, A SINGLE LINE AND A SUPPORT FOR FIXING YOUR CATCHES TO YOUR BELT



STRING RELEASER

Code: **425620**

- A SINGLE LINE AND A PIN WITH A HOLE FOR STRAIGHTENING SHAFTS AND FREEING SHAFTS STUCK IN ROCKS

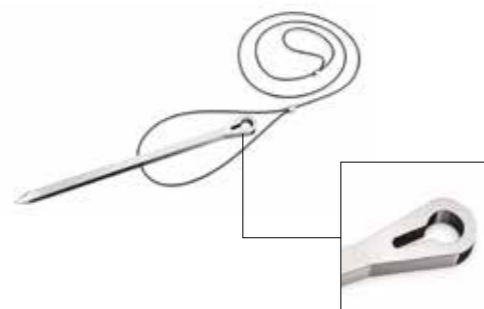

EOS ALPHA

Code: **425663**

- SINGLE 1-WATT LED
- REFLECTOR - POLYCARBONATE (HOT SPOT)
- SLIDING MAGNETIC SWITCH WITH CONTINUOUS-ON OR OFF POSITION
- POWERED BY 4 1.5V AA BATTERIES (NOT INCLUDED)
- 900 MINUTES OF CONTINUOUS BURN TIME, 2100 MINUTES WITH INTERMITTENT 60 SECOND ON/OFF
- WATERPROOF DOWN TO 50M / 165FT



EOS BEAM

Code: **425664**

- CREE LED 1053 LUMENS
- POWERFUL LIGHT BEAM
- VERY CONCENTRATED BEAM
- VISUAL BATTERY INDICATOR
- EASY-TO-USE SWITCH
- HANDY AND COMPACT
- LED CHARGE INDICATOR
- IN-HOUSE RECHARGEABLE BATTERY
- USB CHARGER CABLE
- ADJUSTABLE WRIST STRAP
- PADDED CASE WITH ZIP



TECHNICAL FEATURES

Max depth	50 m/164ft
Switch	Magnetic switch (continuous-on or off position)
Batteries (not included)	4AA Alkaline 4AA Rechargeable(2700 mAh)
Reflector	Polycarbonate (Hot Spot)
Front lens	Polycarbonate, 3mm thick
Head	Polycarbonate
Maximum diameter (head)	43mm
Diameter of tubular grip (body)	25mm
Total length	153mm
Bulb	Mono LED 1W/120 lumens
Color temperature	6750 °K

TECHNICAL FEATURES

Bulb	XM-L2
Switch Mode	High
Led lumens (25°)	1000
Burn time (min)	90
Color Temperature	5800 - 7300
Light beam (1m distance)	Hot Spot (12°)
(mm/in)	220 / 8.6
Rechargeable Batteries	1x ICR18650
Time to charge	300min
Total length	158.7mm / 6.2in
Head diameter	28mm / 1.1in
Body diameter	26mm / 1in
Weight with batteries	188.5g / 6.6oz
Max. operation depth	100m / 328ft

HYDRO PROPEL

Code: 425722

- VERY LARGE BUOY WITH RUGGED OUTER COVER
- ORANGE NYLON OFFERS GREAT RESISTANCE AND VISIBILITY
- 2 LARGE D-RINGS WITH OPTIMIZED DRAG POINTS INCREASE GLIDE OVER THE WATER
- 6 LARGE NYLON D-RINGS
- 8 LARGE NYLON D-RINGS ON THE SIDE
- 20CM X 20CM DIVE FLAG
- PUMP INCLUDED
- INFLATABLE UP TO 0.15 BAR
- DOUBLE CHAMBER
- SHOULDER BAND
- EQUIPMENT FIXING SYSTEM
- PERFECT BUOYANCY
- MESH POCKET
- 50 LITRE CAPACITY



HYDRO TORPEDO LARGE

Code: 425717

- LARGE BUOY WITH RUGGED OUTER COVER
- 500D ORANGE PVC OFFERING GREAT RESISTANCE, VISIBILITY AND A SMOOTH SURFACE FOR EASE OF MOVEMENT
- S.S. D-RING WITH DRAG POINT OPTIMIZED TO INCREASE GLIDE OVER THE WATER
- 6 NYLON D-RINGS
- 20 METERS OF FLOAT LINE + NYLON SNAP INCLUDED
- 30.5CM X 30.5CM DIVE FLAG



HYDRO FLAT

Code: 425720

- FLAT BUOY WITH RUGGED OUTER COVER
- 500D ORANGE PVC OFFERING GREAT RESISTANCE, VISIBILITY AND A SMOOTH SURFACE FOR EASE OF MOVEMENT
- 7 NYLON D-RINGS
- 20 METERS OF FLOAT LINE + NYLON SNAP INCLUDED
- 30.5CM X 30.5CM DIVE FLAG



HYDRO TORPEDO

Code: 425718

- BUOY WITH A RUGGED OUTER COVER
- 500D ORANGE PVC OFFERING GREAT RESISTANCE, VISIBILITY AND A SMOOTH SURFACE FOR EASE OF MOVEMENT
- 20 METERS OF FLOAT LINE + NYLON SNAP INCLUDED
- NYLON D-RINGS AND 18.5CM X 18.5CM DIVE FLAG



HYDRO SPHERE

Code: 425719

- BUOY WITH A RUGGED OUTER COVER
- 500D ORANGE PVC OFFERING GREAT RESISTANCE, VISIBILITY AND A SMOOTH SURFACE FOR EASE OF MOVEMENT
- 20 METERS OF FLOAT LINE + NYLON SNAP INCLUDED
- NYLON D-RINGS AND 18.5CM X 18.5CM DIVE FLAG



TORPEDO

Code: 425713

- BUOYS MADE OF RESILIENT PVC
- FASTENING RINGS ON THE BOTTOM
- INCLUDES 20 METERS OF LINE AND CARABINER



APNEA

Code: 425711

- BUOY MADE OF RESILIENT PVC
- FEATURES A PEAK WITH RING
- DRAG POINT OPTIMIZED TO INCREASE GLIDE OVER THE WATER



DIVE FLAG

Code: 45200412

- FLAG SIZE: 18.5 X 18.5 CM
- CAN BE MOUNTED ON THE HYDRO TORPEDO (425718), THE HYDRO SPHERE (425719) AND THE HYDRO PROPEL (425722)



LINE HOLDER

Code: 423946

- KEEP YOUR SPEARFISHING LINE ORDERLY WITH MARES' LINE HOLDER



SPHERE

Code: 425714

- BUOYS MADE OF RESILIENT PVC
- FASTENING RINGS ON THE BOTTOM
- INCLUDES 20 METERS OF LINE AND CARABINER



BUOY REEL HYDRO

Code: 423860

- DESIGNED SPECIFICALLY FOR MARES SPEARFISHERS
- THE REEL HELPS THE LINE STAY CLEAR
- 30M OF 1.4MM CLEAR NYLON INCLUDED
- TO BE USED WITH A BUOY AND QUICK RELEASE WEIGHT 425860



DIVE FLAG ALPHA

Code: 45200449

- FLAG SIZE: 30 X 20 CM
- CAN BE MOUNTED ON THE HYDRO TORPEDO (425718), THE HYDRO SPHERE (425719) AND THE HYDRO PROPEL (425722)

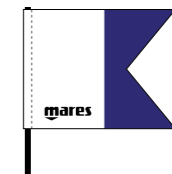

SAFETY WHISTLE

Code: 423930



TRAINING BUOY

Code: 425715



- FOUR OUTSIDE HANDLES FOR PRE-DIVE PREPARATION
- AMPLE INSIDE SPACE TO CONTAIN THE LINE DURING TRANSPORTATION
- EXTERNAL POCKET WITH ZIP
- ORAL INFLATOR AND OVER PRESSURE VALVE
- STAINLESS STEEL D-RING FOR TO CONNECT THE FREE DIVING LINE
- 12 HOLES FOR WATER DRAINAGE
- DIVE FLAG (CODE: 45200301) AND FLAG SUPPORT (CODE: 425716) NOT INCLUDED

TOP



BOTTOM



TECHNICAL FEATURES

Length	Height	Volume
70 cm	17 cm	48 L

BOTTOM PLATE

Code: 425814

- THE BEST FREEDIVING BOTTOM PLATE FOR TRAINING AND COMPETITIONS
- DESIGNED FOR USE WITH Ø 10MM FREEDIVING LINE
- OPTIMAL HYDRODYNAMIC PERFORMANCE THANKS TO ITS SHAPE AND HOLES FOR WATER
- Ø 27CM WHITE PLATE FOR GREAT VISIBILITY FROM A DISTANCE
- CONNECTION HOLES AVAILABLE: 2 FOR ACTION CAMS - 16 FOR VELCRO NAME TAG STRIPS - 32 FOR DEPTH TAGS



HOLDER FOR DIVE FLAG

Code: 425716

- DIVE FLAG HOLDER
- CAN BE USED WITH THE TRAINING BUOY (425715)



DIVE FLAG 30.5 X 30.5 CM

Code: 45200301

- SPARE PART FOR TECH BUOYS
- FLAG: 30.5 X 30.5CM



NOSE CLIP

Code: 423974



- ERGONOMIC SHAPE FOR HANDS-FREE COMPENSATION
- LIGHT AND COMPACT
- SOFT OVER MOLDED AREA FOR MAXIMUM GRIP AND COMFORT
- CAN BE APPLIED ON THE MASK OR NOSE
- IDEAL FOR SWIMMING AND FREEDIVING IN ALL ENVIRONMENTS
- SYMMETRICALLY FORMED
- ADJUSTABLE LANYARD



COLLAR

Code: 425864 Weight 300g

Code: 425865 Cordura Strap

Code: 425866 Silicone Strap



- SOPHISTICATED FREEDIVING WEIGHT COLLAR SYSTEM
- 300G WEIGHTS WHICH CONNECT INDIVIDUALLY
- EASY WEIGHT ADJUSTMENT
- WHITE WEIGHTS FOR BETTER VISIBILITY AND NICE DESIGN
- TWO ADJUSTABLE STRAPS: CORDURA OR SILICONE
- BUCKLES ARE DESIGNED FOR SIMPLE AND INTUITIVE USE



LANYARD FREEDIVING

Code: 423992 - Lanyard Freediving

Code: 423995 - Lanyard Freediving with snap release



- RELEASABLE SAFETY CABLE
- SAFETY RELEASE SYSTEM ON THE BRACELET
- STAINLESS STEEL SNAP HOOK
- COATED STEEL CABLE, YELLOW COLOR AND 100CM LONG
- TWO SWIVELS AT THE EXTREMITIES OF THE CABLE
- THE LANYARD IS MANDATORY IN COMPETITION, AND RECOMMENDED DURING COURSES AND TRAINING



SWIM APNEA CAP

NEW

Code: 425868



- A SILICONE SWIMMING CAP FOR FREEDIVING COMPETITIONS



SIBK



WHBK

BELT ELASTIC W/NYLON BUCKLE

Code: 425812 WH/BK

- QUICK-RELEASE NYLON BUCKLE
- 3 MM ELASTIC TAPE, 140 CM LONG



BELT ELASTIC W/MARSEILLAISE S.S

Code: 425813 WH/BK

- STAINLESS STEEL, QUICK-RELEASE BUCKLE
- 3 MM ELASTIC TAPE, 140 CM LONG



QUICK-RELEASE WEIGHT

Code: 425860

- 1 KG QUICK-RELEASE WEIGHT, FAST AND EASY TO USE
- IDEAL FOR BUOYANCY CHANGES
- EXCLUSIVE MARES PATENT



SNAP HOOK

Code: 423945

- 2 PCS



UNDERWATER SLATE

Code: 415719

- BRIGHT WHITE WRITING SLATE
- COMPACT SIZE: 12 X 15CM
- HOOK SYSTEM TO ATTACH TO YOUR BCD
- QUICK RELEASE BUCKLE
- STANDARD REPLACEABLE PENCIL WITH SILICONE TUBE



PERSONAL DRY BOX

Code: 415727

- LANYARD FOR TRANSPORTATION
- DRY SEAL FOR WATERTIGHT CLOSURE
- SLEEK DESIGN
- SMALL AND DURABLE



NEOPRENE CAP

Code: 425869



- MADE IN 2MM NEOPRENE
- FULLY WIND/WATERPROOF
- SMOOTHSKIN NEOPRENE 'WATER-STOP' BAND INSIDE
- ADJUSTABLE VELCRO® BRAND CLOSURE AT THE BACK
- ONE SIZE



ASCENT PONCHO

NEW

Code: 429514

- UNISEX
- HIGH-QUALITY MICROFIBER (300G/M²)
- VERY SOFT AND LIGHT
- EXCELLENT ABSORBENT QUALITIES
- QUICK DRYING
- FEATURES A DOUBLE-LINED HOOD
- TWO SIDE POCKETS
- IDEAL FOR ALL SPORTS AND CHANGING OUTDOORS



MULTIPRONGS MARES PRO

Code: 423724 - 3P/4P/5P

- HIGHLY HYDRODYNAMIC SHAPE
- GREAT SPEED AND STABILITY, EVEN ON LONGER SHOTS
- THE SPECIAL PRONG ANGLE MEANS GREATER HOLDING POWER TO RESTRAIN PREY
- BLACK PLASTIC BASE WITH RESISTANT TECHNO-POLYMER
- MUSTAD® PRONGS
- THREAD M7
- PACK OF 10PCS



MULTIPRONGS MARES

Code: 423725 - 3P/4P/5P

- HIGHLY HYDRODYNAMIC SHAPE
- GREAT SPEED AND STABILITY, EVEN ON LONGER SHOTS
- SPECIAL PRONG ANGLE
- THE ANGLED PRONGS MEAN GREATER HOLDING POWER TO RESTRAIN PREY
- WHITE PLASTIC BASE WITH RESISTANT TECHNO-POLYMER
- MUSTAD® PRONGS
- THREAD M7
- PACK OF 10PCS



INOX MULTIPRONGS

Code: 423719 - 3P

Code: 423720 - 5P

- STAINLESS STEEL
- BLACK NYLON BASE
- THREAD M7



423719



423720

MULTIPRONGS PROTECTOR

Code: 45200320

- PROTECTION FOR THREE, FOUR AND FIVE PRONGED MARES MULTIPRONGS
- PACK OF 10PCS



BULLET 1 BARB

Code: 423726

- GALVANIZED STEEL PR80
- 10 PCS
- THREAD M7



BULLET 2 BARB

Code: 423727

- GALVANIZED STEEL PR80
- 10 PCS
- THREAD M7



BULLET PRO

Code: 423728

- TEMPERED STAINLESS STEEL
- 10 PCS
- THREAD M7



BULLET MINI

Code: 423729

- STAINLESS STEEL
- 10 PCS
- THREAD M7



SHAFT / GUIDE

NOTE:

All shafts are in 17-4 PH stainless steel unless otherwise specified.

SLG	Sling Gun
PNG	Pneumatic Gun
FINS	'Shark Fin' spear loading point
TRI-FILED	Spear tip finish

TIP PROTECTION

Code: 43200496

- ONLY FOR MARES SHAFTS



SHAFTS FOR PNEUMATIC GUNS

PNG TAHITIAN SHAFT 8

Code: 423265



PNG TAHITIAN SHAFT 7

Code: 423257



DIAMETER: Ø 8 mm	
GUN MODEL: Cyrano 1.3	
LENGTH	GUN SIZE
97 cm	90
107 cm	100
122 cm	110
132 cm	120

DIAMETER: Ø 7 mm	
GUN MODEL: Cyrano 1.1 HFT - Cyrano 1.1	
LENGTH	GUN SIZE
97 cm	90
107 cm	100
122 cm	110
132 cm	120

SHAFTS FOR PNEUMATIC GUNS

PNG THREAD SHAFT 8 ZINC COATED

Code: 423259



DIAMETER: Ø 8 mm	
TYPE: Thread M7	
GUN MODEL: Sten - Jet - Cyrano 1.3	
LENGTH	GUN SIZE
36.9 cm	42
51.9 cm	55
66.9 cm	70
GUN MODEL: Sten	
LENGTH	GUN SIZE
86.9 cm	90
98.4 cm	100

PNG THREAD SHAFT 7 ZINC COATED

Code: 423258



DIAMETER: Ø 7 mm	
TYPE: Thread M7	
GUN MODEL: Cyrano 1.1	
LENGTH	GUN SIZE
35.9 cm	42
86.5 cm	90
96.5 cm	100
106.5 cm	110
GUN MODEL: Cyrano 1.1 - Sten 11	
LENGTH	GUN SIZE
56.9 cm	55
67.1 cm	70

PNG THREAD SHAFT 8

Code: 423260



DIAMETER: Ø 8 mm	
TYPE: Thread M7	
GUN MODEL: Sten - Jet - Cyrano 1.3	
LENGTH	GUN SIZE
36.9 cm	42
51.9 cm	55
66.9 cm	70
GUN MODEL: Sten	
LENGTH	GUN SIZE
86.9 cm	90
98.4 cm	100

SHAFTS FOR SLING GUNS

SLG SHAFT FINS STRIKE 7 TRI-FILED

Code: 423271



DIAMETER: Ø 7 mm	
GUN MODEL: Strike - Strike Element - Strike Polygon - Viper Pro - Viper Pro DS	
LENGTH	GUN SIZE
95 cm	55
115 cm	75
130 cm	90
140 cm	100
150 cm	110
155 cm	115
160 cm	120

SLG SHAFT FINS STRIKE 6.5

Code: 423267

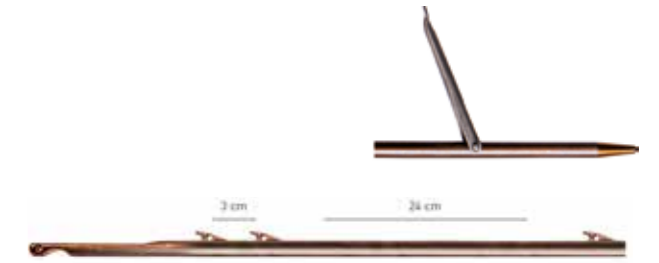

DIAMETER: Ø 6.5 mm	
GUN MODEL: Strike - Strike Element - Strike Polygon - Viper Pro - Viper Pro DS	
LENGTH	GUN SIZE
95 cm	55
115 cm	75
130 cm	90
140 cm	100
150 cm	110
155 cm	115
160 cm	120

SLG SHAFT FINS STRIKE 6

Code: 423270

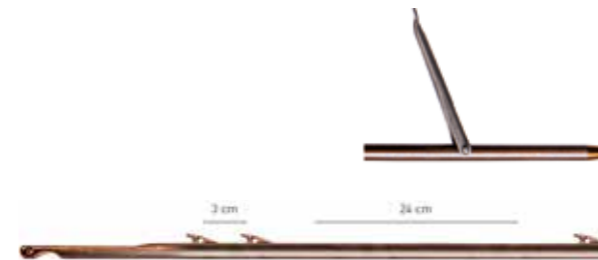

DIAMETER: Ø 6 mm	
GUN MODEL: Strike - Strike Element - Strike Polygon - Viper Pro - Viper Pro DS	
LENGTH	GUN SIZE
95 cm	55
115 cm	75
130 cm	90
140 cm	100
150 cm	110
155 cm	115
160 cm	120

SLG SHAFT 6.5

Code: 423226



DIAMETER: Ø 6.5 mm	
GUN MODEL: Sniper - Sniper PS - Sniper Alpha - Sniper Pro	
LENGTH	GUN SIZE
85 cm	45
115 cm	75
130 cm	90
140 cm	100
150 cm	110
160 cm	120

SHAFTS FOR SLING GUNS

SLG SHAFT 6.25

Code: 423263



DIAMETER: Ø 6.25 mm

GUN MODEL: Sniper - Sniper PS - Sniper Alpha - Sniper Pro

LENGTH	GUN SIZE
140 cm	100
150 cm	110

SLG SHAFT 6

Code: 423262



DIAMETER: Ø 6 mm

GUN MODEL: Sniper - Sniper PS - Sniper Alpha - Sniper Pro

LENGTH	GUN SIZE
85 cm	45
140 cm	100
150 cm	110

SLG SHAFT 6.5 ZINC COATED

Code: 423256



DIAMETER: Ø 6.5 mm

GUN MODEL: Sniper - Sniper PS - Sniper Alpha - Sniper Pro

LENGTH	GUN SIZE
75 cm	35
85 cm	45
115 cm	75
130 cm	90
140 cm	100
150 cm	110

SLG THREAD SHAFT 7 ZINC COATED

Code: 423255



DIAMETER: Ø 7 mm

GUN MODEL: Sniper - Sniper PS - Sniper Alpha - Sniper Pro

LENGTH	GUN SIZE
58 cm	35
68 cm	45
78 cm	55
98 cm	75
113 cm	90

LATEX S-POWER ROLL



- TWO-MATERIAL MARES S-POWER LATEX
- THIN BROWN/INDIGO/GOLD UV PROTECTION OUTSIDE AND NATURAL AMBER LATEX INSIDE
- PROGRESSIVE LATEX AND CONSTANT POWER OVER THE LONG TERM
- 5-METER ROLL



	DIAMETER	COLOR	LENGTH
Code: 423989	Ø 14 mm	BROWN	5 meter roll
Code: 423977	Ø 14 mm	INDIGO	5 meter roll
Code: 423978	Ø 15 mm	GOLD	5 meter roll
Code: 423990	Ø 16,5 mm	BROWN	5 meter roll
Code: 423991	Ø 18 mm	BROWN	5 meter roll

INDIGO / BROWN

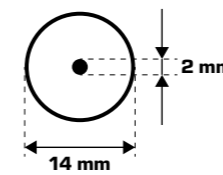

GOLD

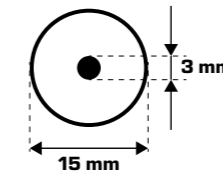

BROWN

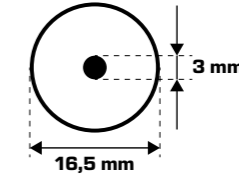

BROWN

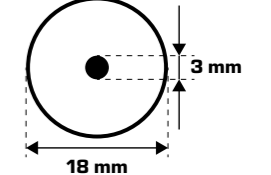

SLING DISPENSER

Code: 423979

- THE SMART SOLUTION FOR SLINGS
- 3-SECTION SLING DISPENSER
- DESIGNED FOR SLINGS WITH A DIAMETER OF 12 TO 20MM
- SLINGS NOT INCLUDED



SCAN THE QR CODE TO SEE OUR SLING REPLACEMENT VIDEO GUIDE



S-POWER SLINGS SPEED CIRCULAR / BLACK

- MARES S-POWER LATEX
- INTERCHANGEABLE WISHBONE IN 2 mm DYNEEMA®
- DESIGNED FOR SHAFTS WITH SPECIALLY POLISHED NOTCHES, PINS OR SHARK FINS
- NO PARACHUTE EFFECT, INCREASES SPEED



Code: 423966

DIAMETER: Ø 16 mm

GUN MODEL: Viper Pro - Viper Pro DS

LENGTH	GUN SIZE
42 cm	75
50 cm	90
55 cm	100
60 cm	110
65 cm	120

Code: 423960

DIAMETER: Ø 17.5 mm

GUN MODEL: Viper Pro - Viper Pro DS

LENGTH	GUN SIZE
42 cm	55
48 cm	75
55 cm	90
60 cm	100
65 cm	110
70 cm	120

Code: 423965

DIAMETER: Ø 19 mm

GUN MODEL: Viper Pro - Viper Pro DS

LENGTH	GUN SIZE
60 cm	100
65 cm	110
70 cm	120

S-POWER SLINGS SPEED CIRCULAR / PROGRESSIVE

- TWO-MATERIAL MARES S-POWER LATEX
- THIN, BROWN/INDIGO LATEX UV PROTECTION OUTSIDE AND NATURAL AMBER LATEX INSIDE
- PROGRESSIVE LATEX SLING OFFERING CONSTANT POWER OVER THE LONG TERM
- INTERCHANGEABLE WISHBONE IN 2 MM DYNEEMA®
- DESIGNED FOR SHAFTS WITH SPECIALLY POLISHED NOTCHES, PINS OR SHARK FINS
- NO PARACHUTE EFFECT, INCREASES SPEED



Code: 423870

DIAMETER: Ø 14 mm / COLOR: BROWN

GUN MODEL: Viper Pro - Viper Pro DS

LENGTH	GUN SIZE
42 cm	75
48 cm	90
55 cm	100
60 cm	110
65 cm	120
70 cm	130

Code: 423871

DIAMETER: Ø 16.5 mm / COLOR: BROWN

GUN MODEL: Viper Pro - Viper Pro DS

LENGTH	GUN SIZE
42 cm	55
48 cm	75
55 cm	90
60 cm	100
65 cm	110
70 cm	120

Code: 423872

DIAMETER: Ø 18 mm / COLOR: BROWN

GUN MODEL: Viper Pro - Viper Pro DS

LENGTH	GUN SIZE
42 cm	55
48 cm	75
55 cm	90
60 cm	100
65 cm	110
70 cm	120

Code: 423874

DIAMETER: Ø 14 mm / COLOR: INDIGO

GUN MODEL: Strike - Strike Element - Strike Polygon

LENGTH	GUN SIZE
42 cm	55
50 cm	75
58 cm	90
64 cm	100
72 cm	115

Code: 423873

DIAMETER: Ø 17 mm / COLOR: INDIGO

GUN MODEL: Strike - Strike Element - Strike Polygon

LENGTH	GUN SIZE
42 cm	55
54 cm	75
63 cm	90
70 cm	100
75 cm	115



S-POWER SLINGS PAIR

- MARES S-POWER LATEX
- CONICAL RING PREVENTS THE PARACHUTE EFFECT AND INCREASES THE SPEED



Code: 423957

DIAMETER: Ø 16 mm

GUN MODEL: Sniper PS

LENGTH	GUN SIZE
16 cm	45
19 cm	55
22 cm	75
24 cm	90
26 cm	100

Code: 423958

DIAMETER: Ø 17.5 mm

GUN MODEL: Sniper PS

LENGTH	GUN SIZE
16 cm	45
19 cm	55
22 cm	75
24 cm	90
26 cm	100
28 cm	110

Code: 423962

DIAMETER: Ø 19 mm

GUN MODEL: Sniper PS

LENGTH	GUN SIZE
19 cm	45
22 cm	55
24 cm	75
26 cm	90
28 cm	100

S-POWER SLINGS CIRCULAR

- MARES S-POWER LATEX
- CONICAL RING PREVENTS THE PARACHUTE EFFECT AND INCREASES THE SPEED



Code: 423970

DIAMETER: Ø 14 mm

GUN MODEL: Sniper - Sniper Alpha - Sniper Pro

LENGTH	GUN SIZE
28 cm	35
30 cm	45
34 cm	55
50 cm	75

Code: 423963

DIAMETER: Ø 16 mm

GUN MODEL: Sniper - Sniper Alpha

LENGTH	GUN SIZE
30 cm	Sniper 45 - Sniper Alpha 35
34 cm	Sniper 45
42 cm	Sniper Alpha 45
44 cm	Sniper Alpha 55
50 cm	Sniper 75
55 cm	Sniper Alpha 75
60 cm	Sniper 90

Code: 423959

DIAMETER: Ø 17.5 mm

GUN MODEL: Sniper - Sniper Pro

LENGTH	GUN SIZE
34 cm	45
42 cm	55
48 cm	75
55 cm	90
60 cm	100
65 cm	110

Code: 423964

DIAMETER: Ø 19 mm

GUN MODEL: Sniper - Sniper Pro

LENGTH	GUN SIZE
48 cm	75
60 cm	90
65 cm	100
70 cm	110

ARTICULATED BIND WISHBONE

Code: 423915



ARTICULATED WISHBONE

Code: 423914



LARIO BIND WISHBONE

Code: 423913



LARIO WISHBONE

Code: 423912



RACE WISHBONE

Code: 423967



WISHBONE TOOL

Code: 423940



SPEED

Code: 423911

- CONNECTOR END FOR CUSTOMIZED SLINGS MADE IN STAINLESS STEEL, SUITABLE FOR DYNEEMA WISHBONES
- DESIGNED FOR SHAFTS WITH SPECIALLY POLISHED NOTCHES, PINS OR SHARK FINS
- NO PARACHUTE EFFECT, INCREASES SPEED



SPEED2

Code: 423916

- CONNECTOR END MADE OF SPECIAL 2mm DYNEEMA® LINE
- DESIGNED FOR SHAFTS WITH SPECIALLY POLISHED NOTCHES, PINS OR SHARK FINS



SPEED3

Code: 423936

- CONNECTOR END MADE OF SPECIAL 2mm DYNEEMA® LINE, SUITABLE FOR A DYNEEMA WISHBONE
- DESIGNED FOR SHAFTS WITH SPECIALLY POLISHED NOTCHES, PINS OR SHARK FINS
- NO PARACHUTE EFFECT, INCREASES SPEED



PAIR OF SLINGS SUPPORT

Code: 423944



LINE DYNEEMA

Code: 423993

- SPECIAL 2mm DYNEEMA , THE BEST MATERIAL FOR WISHBONES
- 10 METERS



DIAMOND LINE**DIAMOND LINE 1 mm**

Code: 423922

**TECHNICAL FEATURES**

Materials	100% Dyneema core HT Polyester covering 
Diameter	1 mm
Resistance	120 kg
Length of roll	100 meters

DIAMOND LINE 1,5 mm

Code: 423921

**TECHNICAL FEATURES**

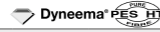
Materials	100% Dyneema core HT Polyester covering 
Diameter	1,5 mm
Resistance	180 kg
Length of roll	100 meters

DIAMOND LINE 2 mm

Code: 423920

**TECHNICAL FEATURES**

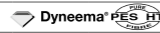
Materials	100% Dyneema core HT Polyester covering 
Diameter	2 mm
Resistance	300 kg
Length of roll	50 meters

CAMO LINE

Code: 423804

**TECHNICAL FEATURES**

Materials	HT Polyester covering 
Diameter	1,65 mm
Resistance	100 kg
Length of roll	100 meters

BLACK LINE

Code: 423803

**TECHNICAL FEATURES**

Materials	HT Polyester covering 
Diameter	1,6 mm
Resistance	80 kg
Length of roll	50 meters

BLACK MONOLINE

Code: 423931

**TECHNICAL FEATURES**

Materials	Nylon
Diameter	1,5 mm
Resistance	80 kg
Length of roll	25 meters

HP GAUGE

Code: 423947

- HP GAUGE FOR MARES PNEUMATIC GUNS
- WHEN YOU ATTACH THIS ACCESSORY ON THE INLET VALVE, THE GAUGE SHOWS THE PRESSURE OF THE GUN

**CLEVER LOADER**

Code: 423941

- MULTI-FUNCTIONAL LOADER FOR SHAFTS FITTED WITH SPEAR TIPS OR MULTIPRONGS
- LOADER ALSO FEATURES TABS FOR UNSCREWING A PNEUMATIC GUN VALVE COVER CAP

**LINE SLIDER RACE**

Code: 423937 8 mm

Code: 423938 7 mm

- COMPACT HYDRODYNAMIC LINE SLIDER
- FOR PNEUMATIC GUNS WITH A 7MM / 8MM SHAFT
- PACK OF 5PCS

**HANDLE GRIP ,KJ'**

Code: 423973

- PREFORMED GRIP
- BETTER MANAGEABILITY AND EXCELLENT STABILITY
- NEW DESIGN FACILITATES EASIER AIMING
- CAN BE USED ON THE CYRANO EVO, CYRANO EVO HF, VIPER PRO AND VIPER PRO DS

**INJECTOR**

Code: 423901

- MANUAL AIR INJECTOR FOR MARES PNEUMATIC GUNS

**LONG CLEVER LOADER**

Code: 423942

- LONG VERSION OF THE CLEVER LOADER
- IT ALLOWS THE USER TO LOAD PNEUMATIC GUNS SAFELY AND EASILY

**SLING PROTECTION**

Code: 423939

- INTENDED FOR USE ON SLING GUNS WHEN NOT IN USE
- HELPS SAFEGUARD AGAINST PREMATURE AGING OF THE SLINGS DUE TO EXPOSURE TO THE SUN



VERTICAL SPIRO 65

Code: 423933

- 65 mm SPOOL
- DESIGNED SPECIFICALLY FOR MARES SPEARGUNS
- THE LINE GUIDE ON THE REEL HELPS THE LINE PASS SNUGLY ALONG THE OUTER BARREL
- MARES PATENTED CLUTCH



TECHNICAL FEATURES

Cyrano 1.1 HFT - Cyrano 1.1 - Cyrano 1.3 - Viper Pro - Viper Pro DS - Sniper - Sniper Pro - Sniper PS - Sniper Alpha

423804	423803	423922	423921	423920
Camo line Ø 1,6mm - 80kg	Black line Ø 1,65mm - 100kg	Diamond line Ø 1mm - 130kg	Diamond line Ø 1,5mm - 180kg	Diamond line Ø 2mm - 300kg
30 m	30 m	55 m	35 m	20 m

VERTICAL SPIRO 87

Code: 423934

- 87 mm SPOOL
- DESIGNED SPECIFICALLY FOR MARES SPEARGUNS
- THE LINE GUIDE ON THE REEL HELPS THE LINE PASS SNUGLY ALONG THE OUTER BARREL
- MARES PATENTED CLUTCH



TECHNICAL FEATURES

Cyrano 1.1 HFT - Cyrano 1.1 - Cyrano 1.3 - Viper Pro - Viper Pro DS - Sniper - Sniper Pro - Sniper PS - Sniper Alpha

423804	423803	423922	423921	423920
Camo line Ø 1,6mm - 80kg	Black line Ø 1,65mm - 100kg	Diamond line Ø 1mm - 130kg	Diamond line Ø 1,5mm - 180kg	Diamond line Ø 2mm - 300kg
60 m	60 m	85 m	65 m	40 m

REEL FOR STRIKE

Code: 423980

- LINE NOT INCLUDED



BARB KEEPER O-RING

Code: 423926



BUNGEE WITH BIG CARABINER

Code: 423935

- L



BUNGEE

Code: 423923

- M-L



SLEEVES PLIER

Code: 423968



SLEEVES KIT

Code: 423924 - For Monoline 1,4 / 1,6 mm

Code: 423925- For Monoline 1,2 / 1,4 mm

- 20 PCS



CAMERA BRACKET FOR STRIKE GUNS

Code: 423976

- ATTACHMENT POINT FOR VIDEO & CAMERA GEAR
- MOUNTS TO MARES' STRIKE SERIES OF GUNS
- EASY CONNECTION
- LEFT/RIGHT POSITIONING



CAMERA BRACKET FOR VIPER

Code: 423948

- ATTACHMENT POINT FOR VIDEO & CAMERA GEAR
- MOUNTS TO MARES GUNS THAT HAVE VERTICAL SPIRO REELS



CAMERA BRACKET FOR PNEUMATIC GUNS

Code: 423971

- FOR Ø 40 mm O.D. BARRELS



CONNECTING KNOB FOR CAMERA

Code: 423949

- THREAD UNC 1/4"



SHARK CLIP WITH SWIVEL

Code: 423969



UNIVERSAL HANGER

Code: 415177

- HOLDS UP TO 15 DIFFERENT ITEMS
- UNIQUE MARES DESIGN
- STURDY AND ROBUST
- EQUIPMENT PERFECTLY ORGANIZED



NEOPRENE GLUE

Code: 415108

- 20 ml



SILICONE GREASE

Code: 415102

- 20 ml



ANTIFOG

Code: 415101

- 60 ml



A Q U A Z O N E



SNORKELING CARRY-ALL BAG

NEW

Code: 415613

- GENEROUSLY SIZED: 46 X 62 CM
- MADE OF R-PET (RECYCLED PET) FABRIC
- PERFECT FOR CARRYING YOUR SNORKELING EQUIPMENT AND BEACH TOYS FOR THE KIDS
- ALSO GREAT FOR DRYING YOUR EQUIPMENT
- CLOSURES WITH A CORD THAT CAN ALSO BE USED AS A SHOULDER STRAP
- SLIDING CLOSURE AND CARABINER

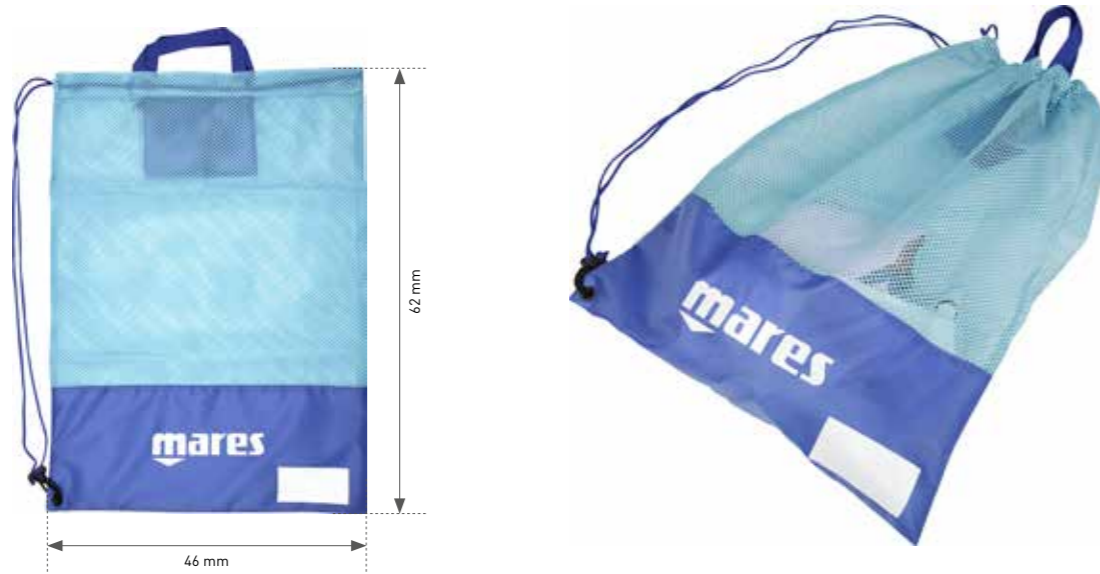

SEASIDE DRY BAG

NEW

Code: 415610 - 5 liters

Code: 415611 - 10 liters

Code: 415612 - 20 liters

- THREE SIZES TO MEET EVERY NEED: 5, 10, AND 20 LITERS
- PROTECTS YOUR PERSONAL ITEMS AGAINST WATER*
- WATERPROOF MATERIAL COVERED IN FABRIC
- ROLLING CLOSURE WITH BUCKLE
- FASTENER D-RING



*Any damage caused by submerging the bag in water will not be refunded. This is not a flotation or water safety device

SEASIDE

Aquazone Seaside products are the perfect combination of comfort and practicality for spending leisure time on the beach. Designed to accompany our snorkeling equipment by dressing the user head to toe, while not losing sight of our commitment to the environment. At every possible opportunity, we've chosen fabrics derived from recycled materials and packaging with low environmental impact.



SEASIDE BEACH BAG

NEW

Code: 415609

- MADE OF R-PET (RECYCLED PET) FABRIC
- SWITCH BETWEEN A SHOULDER BAG AND A SHOPPING TOTE
- MAGNETIC CLOSURE
- EXTERNAL TOWEL-CARRYING TIES
- POCKET INSIDE WITH ZIPPER
- SEMI-RIGID BOTTOM
- TOGETHER WITH THE SEASIDE TOWEL, IT MAKES FOR THE PERFECT COMFY SPOT ON THE BEACH (SOLD SEPARATELY, CODE 415607)
- 30 LITER CAPACITY



AQ

COR

SEASIDE TOWEL

NEW

Code: 415607

- POLYESTER MICROFIBER 200 G/M²
- DIMENSIONS 80 X 160 CM
- EXCLUSIVE MARES PRINT
- ELASTIC LOOP FOR ROLLED STORAGE
- ATTACHMENT BUTTONS FOR INTEGRATING WITH THE SEASIDE BEACH BAG
- MATCHES PERFECTLY WITH BOTH SEASIDE BEACH BAG COLORS (SOLD SEPARATELY, CODE 415609)



Our new bag is perfect to take with you to the beach or the boat. A unique shape makes it convenient and spacious.

- Made of R-PET (recycled PET) fabric
- Dual handles let you carry it like shopping tote or a shoulder bag
- Magnetic closure
- External ties for attaching your beach towel, leaving a maximum amount of space inside the bag
- Large internal pockets with zipper
- Semi-rigid bottom
- Bring the new microfiber SEASIDE TOWEL and relax in comfort with everything close at hand
- The SEASIDE TOWEL and SEASIDE BEACH BAG match perfectly in both colors (SEASIDE TOWEL sold separately with code 415607)

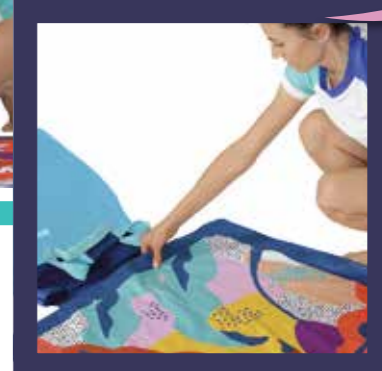

SEASIDE PONCHO JUNIOR

NEW

Code: 415608

- POLYESTER MICROFIBER 200 G/M²
- EXCLUSIVE MARES PRINT
- HOOD
- ELASTIC LOOP, HANDY FOR HANGING OR ROLLED STORAGE
- ONE SIZE, FOR CHILDREN AGED 5 - 13*



Buttons under the arms for holding the poncho closed, while still allowing for freedom of movement



AQ



BL



*Approximate age; the fit depends on the physical characteristics of the user.

RASHGUARD SHIELD

NEW

Code: 412461 Man

Code: 412462 Woman

- MADE IN STRETCH R-PET (RECYCLED PET) AND SPANDEX
- WEIGHT IN GRAMS 200 G/M²
- T-SHIRT CUT WITH REGULAR FIT
- EXCLUSIVE MARES PRINT, MADE IN PU COMBINED WITH STRETCH FABRIC
- COLORS MATCH THE KEEWEE COMBO 411810 AND KEEWEE MASK 411075



TECHNICAL FEATURES

Thickness	200 g/m ²						
Fabric Type	Stretch R-PET (Recycled PET) and Spandex						
Man sizes	XS	S	M	L	XL	XXL	3XL
Woman sizes	XXS	XS	S	M	L	XL	3XL

RASHGUARD SHIELD YOUTH **NEW**

Code: 412463

- MADE IN STRETCH R-PET (RECYCLED PET) AND SPANDEX
- WEIGHT IN GRAMS 200 G/M²
- T-SHIRT CUT WITH REGULAR FIT
- EXCLUSIVE MARES PRINT, MADE IN PU COMBINED WITH STRETCH FABRIC
- COLORS MATCH THE KEEWEE JR MASK 411076 AND KEEWEE JR COMBO 411811



MG

LM

TECHNICAL FEATURES

Weight	200 g/m ²				
Fabric Type	Stretch R-PET (Recycled PET) and Spandex				
Sizes	XS	S	M	L	XL
Ages*	8/9	9/10	10/11	11/12	12/13

RASHGUARD SHIELD KID **NEW**

Code: 412464

- MADE IN STRETCH R-PET (RECYCLED PET) AND SPANDEX
- WEIGHT IN GRAMS 200 G/M²
- T-SHIRT CUT WITH REGULAR FIT
- EXCLUSIVE MARES PRINT, MADE IN PU COMBINED WITH STRETCH FABRIC
- COLORS MATCH THE KEEWEE JR MASK 411076 AND KEEWEE JR COMBO 411811



LM



MG

TECHNICAL FEATURES

Thickness	200 g/m ²				
Fabric Type	Stretch R-PET (Recycled PET) and Spandex				
Sizes	XS	S	M	L	XL
Ages*	2/3	3/4	4/5	5/6	6/7

* Ages indicated in the table are purely for reference

AQUASHOES SEASIDE **NEW**

Code: 441091 Adult

Code: 441092 Junior

- NON-MARKING TPR SOLE
- MICRO-MESH UPPER FOR WATER DRAINAGE
- MINIMAL STITCHING FOR BETTER FOOT COMFORT
- REINFORCED TOE AND HEEL AREAS
- CLOSURE: VELCRO® BRAND FASTENER



441091 / COLOR VARIATIONS



GR

NV

PT

441091 / TECHNICAL FEATURES

Adult sizes	36	37	38	39	40	41	42	43	44	45	46
-------------	----	----	----	----	----	----	----	----	----	----	----

441092 / COLOR VARIATIONS



YL

BL

AQ

441092 / TECHNICAL FEATURES

Junior sizes	28	29	30	31	32	33	34	35
--------------	----	----	----	----	----	----	----	----

SLIPPER CLOUD **NEW**

Code: 441103 Man

Code: 441105 Woman

Code: 441104 Junior

- PE SANDAL WITH THREE LAYERS
- INSOLE WITH NONSLIP PATTERN
- RUBBER UPPER WITH LOGO



441103 / COLOR VARIATIONS



NV

RY

BK

441103 / TECHNICAL FEATURES

Man sizes	41	42	43	44	45	46
-----------	----	----	----	----	----	----

441105 / COLOR VARIATIONS



NVRY

PK

BK

441105 / TECHNICAL FEATURES

Woman sizes	35	36	37	38	39	40
-------------	----	----	----	----	----	----

441104 / COLOR VARIATIONS



RY

PK

441104 / TECHNICAL FEATURES

Junior sizes	28	29	30	31	32	33	34
--------------	----	----	----	----	----	----	----

GAMMA

NEW

GAMMA JR

NEW

Code: 411343

- TPR SKIRT
- POLYCARBONATE LENSES
- ANTI-FOG AND UV BLOCKING TREATMENT
- ADJUSTING BUCKLES WITH DOUBLE BUTTONS
- SPLIT SILICONE STRAP



SMKBK



BLBL



CLBL



CLBL

Code: 411344

- TPR SKIRT
- POLYCARBONATE LENSES
- ANTI-FOG AND UV BLOCKING TREATMENT
- ADJUSTING BUCKLES WITH DOUBLE BUTTONS
- SPLIT SILICONE STRAP

ROCKET SILICONE

NEW

METEOR

NEW

Code: 411785

- SILICONE SEALS
- POLYCARBONATE LENSES
- ANTI-FOG AND UV BLOCKING TREATMENT
- ADJUSTABLE NOSEPIECE
- SPLIT SILICONE STRAP, EASY TO ADJUST
- ADULT FIT



COLOR VARIATIONS



Code: 411786

- ENTIRE STRUCTURE IN SILICONE
- POLYCARBONATE LENSES
- ANTI-FOG AND UV BLOCKING TREATMENT
- LEVER BUCKLES FOR PRECISE ADJUSTMENT
- SPLIT SILICONE STRAP FOR MAXIMUM HOLD
- JUNIOR FIT



COLOR VARIATIONS

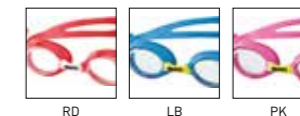

STAR

NEW

Code: 411787

- SOFT SEALS
- POLYCARBONATE LENSES
- ANTI-FOG AND UV BLOCKING TREATMENT
- ADJUSTABLE NOSEPIECE
- SPLIT RUBBER STRAP, EASY TO ADJUST
- JUNIOR FIT



COLOR VARIATIONS





FINS

ADULT / JUNIOR



ADULT

NATEEVA

Code: 410513

- ADJUSTS USING A STRAP WITHOUT BUCKLES
- ULTRA-COMFORTABLE FOOT POCKET
- SYSTEM TO FASTEN FINS TOGETHER FOR EASIER TRANSPORT



COLOR VARIATIONS

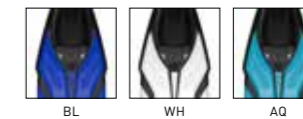

SIZE CHART

Sizes	EU	UK	USA
XS	30/34	11.5/2	12.5/3
SM	35/38	2.5/5	3.5/6
ML	39/43	5.5/9	6.5/10
LXL	44/47	9.5/12	10.5/13

FITTING

	XS	SM	ML	LXL
AQUA (AQ)	■	-	-	-
WHITE (WH)	-	■	■	■
BLUE (BL)	■	■	■	■

PACKAGING



SP

NATEEVA

The Nateeva fin combines an open heel that has a soft, comfortable fit, with a lightweight and responsive blade. It features multi-fit sizing that's suitable for different feet, including junior sizes.



STRAP AND ADJUSTMENT

Among our open-heel snorkeling fins, this is the one that is the easiest and most intuitive to adjust: the strap offers six adjustments for a comfortable and secure hold.

BLADE FASTENING SYSTEM

The blade and foot pocket features a handy connecting system. In one simple motion, fasten the fins together for easier transport.

CLIPPER

Code: 410344

- ULTRA COMFORTABLE FOOT POCKET
- EVA BLADE
- EXTREME HIGH-EFFICIENCY BLADE
- DURABLE CONSTRUCTION



COLOR VARIATIONS



SIZE CHART

Sizes	EU	UK	USA
030	30/32	10.5/12	11.5/13
033	33/34	0/1	1/2
035	35/36	1.5/2.5	2.5/3.5
037	37/38	3/4	4/5
039	39/40	4.5/5.5	5.5/6.5
041	41/42	6/7	7/8
043	43/44	7.5/8.5	8.5/9.5

PACKAGING



SA

X-ONE

Code: 410337



- BUCKLE-FREE STRAP DESIGN
- RIDDLED FOOT POCKET AVOIDS PARACHUTE EFFECT
- TRAVEL FRIENDLY SHORT BLADE
- CHANNEL THRUST TECHNOLOGY



COLOR VARIATIONS

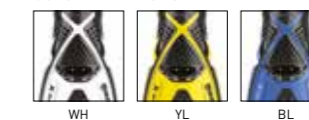

SIZE CHART

Sizes	EU	UK	USA
SM	35/38	2.5/5	3.5/6
ML	39/43	5.5/9	6.5/10
LXL	44/47	9.5/12	10.5/13

PACKAGING



SA

*Available only from 30 to 35

MANTA

Code: 410333

- COMFORTABLE FOOT POCKET
- RUBBERIZED SIDE RIBS
- BLADE'S CONSTRUCTION OPTIMIZES EFFICIENCY
- 2 CHANNEL DESIGN FOR ADDED PROPULSION
- DURABLE CONSTRUCTION



HERMES

Code: 410328



- COMFORTABLE, SOFT FOOT POCKET
- TRAVEL FRIENDLY SHORT BLADE
- IDEAL FOR SWIM TRAINING OR SNORKELING IN CALM WATER



COLOR VARIATIONS



SIZE CHART

Sizes	EU	USA
036	36/37	4/5
038	38/39	6/7
040	40/41	7.5/8.5
042	42/43	9/10
044	44/45	10.5/11.5
046	46/47	12/13

PACKAGING



SA

COLOR VARIATIONS



SIZE CHART

Sizes	EU	UK	USA
034	34/35	3/4	1.5/2.5
036	36/37	4/5	3.5/4.5
038	38/39	5/6	5/6
040	40/41	6/7	6.5/7.5
042	42/43	8/9	8/9
044	44/45	9.5/10.5	9.5/10.5
046	46/47	11/12	11/12

PACKAGING



SF

X-ONE JR

Code: 410345



- BUCKLE-FREE STRAP DESIGN
- RIDDLED FOOT POCKET AVOIDS PARACHUTE EFFECT
- TRAVEL FRIENDLY SHORT BLADE
- CHANNEL THRUST TECHNOLOGY



COLOR VARIATIONS

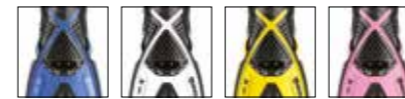

SIZE CHART

Sizes	EU	UK	USA
XS	24/29	7/10.5	7.5/11
S	30/34	11.5/2	12/13

PACKAGING



SA

MANTA JR

Code: 410339

- COMFORTABLE FOOT POCKET
- RUBBERIZED SIDE RIBS
- BLADE'S CONSTRUCTION OPTIMIZES EFFICIENCY
- 2 CHANNEL DESIGN FOR ADDED PROPULSION
- DURABLE CONSTRUCTION



COLOR VARIATIONS



SIZE CHART

Sizes	EU	USA
027	27/29	9/12.5
031	31/33	1/2
034	34/35	2.5/3.5

PACKAGING



SA

FINS ADULT



	Nateeva	X-One	Clipper	Manta	Hermes
Code	410513	410337	410344	410333	410328
Colors	<ul style="list-style-type: none"> ● AQ ● BL ○ WH 	<ul style="list-style-type: none"> ● BL ○ WH ● YL 	<ul style="list-style-type: none"> ● BL ● PK* ○ WH ● YL 	<ul style="list-style-type: none"> ● RBL ● RYL ○ WH 	<ul style="list-style-type: none"> ● BL ● YL
Sizes	XS - SM - ML - LXL	SM - ML - LXL	030 - 033 - 035 - 037 - 039 - 041 - 043	036 - 038 - 040 - 042 - 044 - 046	034 - 036 - 038 - 040 - 042 - 044 - 046
Riddled Footpocket		■			
Channel Thrust		■	■	■	

FINS JUNIOR



	X-One Jr	Manta Jr
Code	410345	410339
Colors	<ul style="list-style-type: none"> ● BL ● PK ○ WH ● YL 	<ul style="list-style-type: none"> ● RBL ● RYL ○ WH
Sizes	XS - S	027 - 031 - 034
Riddled Footpocket	■	
Channel Thrust	■	■



MASKS &
SNORKELS
ADULT / JUNIOR



* Available only from 030 to 035

SEA VU DRY +

Code: 411260

- TRANSPARENT SURFACES TO CLEARLY SEE THE FACE
- ERGONOMIC FRAME DESIGN
- SAFE EXCHANGE AND CLEARING OF GASSES, LOW CO₂ BUILD-UP
- LARGE AIR-FLOW SECTIONS
- FLAT LENSES COMBINE TO BUILD A 3D SHAPE WHICH REDUCES OPTICAL DISTORTION



COLOR VARIATIONS



LMSK BLCL WHCL WHLM PKWH

PACKAGING



SC

FITTING

	SM	LXL
WHLM	■	
PKWH	■	
BLCL	■	■
LMSK		■
WHCL		■

SEA VU DRY+

TESTED CO₂ BUILD UP

When breathing occurs within a closed volume, it can cause CO₂ (carbon dioxide) build-up. Our Research and Development team studied dozens of prototypes, and conducted countless tests with our ANSTI machine, which allows us to measure the residual amounts of CO₂ at varying breathing intensity and frequency, in order to identify the best technical solutions. Reference regulations are EU Standards EN250 and EN14143, widely used in the Scuba Diving industry.

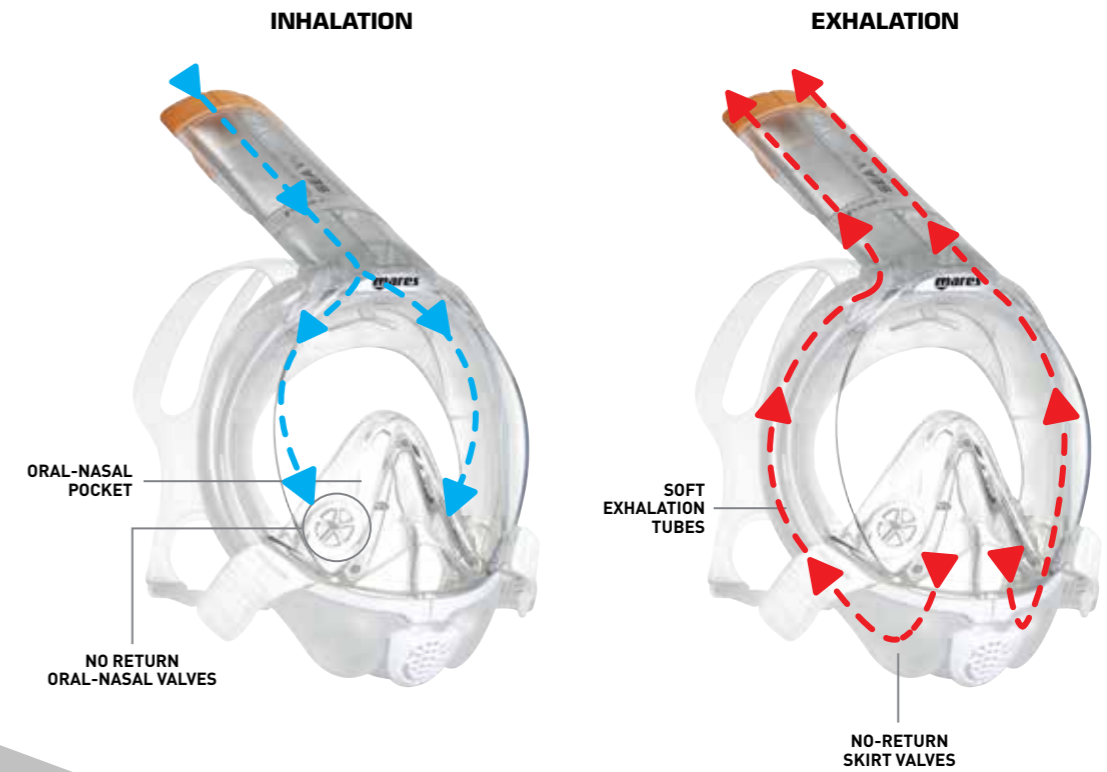

KEEWEE

Code: 411075



- SKIRT IN SILICONE
- RUGGED AND DURABLE CONSTRUCTION
- SOFT AND ELASTIC STRAP
- SLIDING ADJUSTMENT SYSTEM

BRAVE TT

Code: 411077



- SKIRT IN BI-ELASTOMER WITH EXCLUSIVE TWINTech TECHNOLOGY
- POLYCARBONATE LENS WITH ANTI-FOG TREATMENT
- SILICONE STRAP
- ADJUSTING BUCKLES

BRAVE TT & BRAVE TT JR

The Brave TT and Brave Jr. TT masks are ultralight, colorful, and feature an incredibly soft bi-elastomer skirt.



COLOR VARIATIONS



BLWCL MTWCL

COLOR VARIATIONS

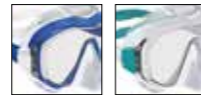

BLWCL WHACL

FITTING



FITTING



PACKAGING



SC

PACKAGING



BX



SPECIFICS FOR THE SKIRT

The skirt on both versions is made of a bi-elastomer with Twintech technology, an exclusive process derived from Mares Liquidskin technology, featuring a stiffer area supporting the lens, with a softer section in contact with the face, for optimal comfort.

LENS

Lens is made of polycarbonate with anti-fog treatment, combining light weight and excellent optical properties. In both the adult and junior versions.

BUCKLES AND HEAD STRAP

The silicone strap optimizes the seal in a comfortable and secure fashion. The lever buckles make adjustments quick and effective.

TRYGON

Code: 411262



- SILICONE SKIRT
- STURDY, DURABLE CONSTRUCTION
- INTEGRATED BUCKLES ON FRAME

WAHOO

Code: 411238



- SILICONE SKIRT
- EZ ADJUST BUCKLES ON SKIRT
- DURABLE CONSTRUCTION
- WIDE VIEWING ANGLE



COLOR VARIATIONS



YLBK BLWCL AQWCL

COLOR VARIATIONS



RYLCL RBLCL RBK BK AQWCL

FITTING



FITTING



PACKAGING



SC

PACKAGING



SC

PURE VISION

Code: 411217



- SILICONE SKIRT
- EZ ADJUST BUCKLES ON SKIRT
- WIDE VIEWING ANGLE

RAY

Code: 411242



- SILICONE SKIRT
- STURDY AND DURABLE CONSTRUCTION
- INTEGRATED BUCKLES ON FRAME



COLOR VARIATIONS



BKBK CLBL

COLOR VARIATIONS



YLWCL BLWCL BK7BK LIWCL

FITTING



FITTING



PACKAGING



SC

PACKAGING



SC

VENTO

Code: 411316



- SILICONE SKIRT
- EZ ADJUST BUCKLES ON SKIRT
- WIDE DOWNWARDS VIEWING ANGLE

RIDLEY

Code: 411263



- MEDIUM SIZED SILICONE SKIRT
- EZ ADJUST BUCKLES ON SKIRT



COLOR VARIATIONS



RYLCL RBLCL BKBK

COLOR VARIATIONS

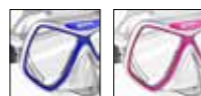

BLWCL PKWCL

FITTING



FITTING



PACKAGING



SC

PACKAGING



SC

ZEPHIR

Code: 411319



- SILITER SKIRT
- EZ ADJUST BUCKLES ON SKIRT
- WIDE VIEWING ANGLE

STREAM

Code: 411239



- SILITER SKIRT
- EZ ADJUST BUCKLES ON SKIRT
- WIDE DOWNWARDS VIEWING ANGLE



COLOR VARIATIONS



RYLCL RBLCL BKBK

COLOR VARIATIONS



RYLCL RBLCL

FITTING



FITTING



PACKAGING



GU

PACKAGING



GU

STARFISH

Code: 411348



- SILITER SKIRT
- PIVOTING BUCKLES ON FRAME

TRYGON JR

Code: 411264



- SILICONE SKIRT
- STURDY, DURABLE CONSTRUCTION
- INTEGRATED BUCKLES ON FRAME



COLOR VARIATIONS



YLBK

BLCL

COLOR VARIATIONS



BLWCL

PKWCL

FITTING



FITTING



PACKAGING



GU

PACKAGING



SC

RECREATIONAL & RESPONSIBLE

Our Aquazone range of recreational products for the entire family was our first group of products to feature our sustainable packaging initiative.

We introduced the first reusable mesh bags many years ago, and we continue striving to find new solutions with the goal of reducing our environmental impact.

We removed PVC from our packaging, replacing it with bioplastics or R-PET (Recycled PET). Even our meshbags have evolved! Today we produce them using recycled materials, and our packaging has switched from polypropylene to cardboard.

Last but not least, we haven't lost sight of product safety from a raw material standpoint: Our products are made with high quality materials, in compliance with the European REACH regulations, the highest level of protection for human health and the environment.



GREEN 'BIO-PLASTIC' POLYBAGS

The new way to package all Mares fins and snorkels.



NO PVC

Mares is replacing PVC packaging stickers with paper ones.



DURABLE YET SUSTAINABLE

Replacements perform just like standard plastic.



70 YEARS = 70% -

Since Mares hit 70 years in 2019, we have been dedicated to reducing plastic use by 70%.



CO₂ MARES REDUCES ITS ENVIRONMENTAL FOOTPRINT

by using ethanol extracted from sugar cane instead of crude oil for 'bio-plastic' polybags, which significantly reduces carbon emissions.



SUSTAINABLE SHIPPING

We are also significantly cutting down the use of plastic when shipping packages, with no more plastic air cushions or bubble wrap used as filling material.



REUSABLE MESH BAGS

Our reusable mesh bags are made from a bio-plastic front panel and a woven R-PET back panel using PET from recycled and transformed plastic bottles. Great for product packaging and reusable for collecting trash while diving.



BLUE OCEANS
PLASTIC FREE



KEEWEE JR

Code: 411076



- SKIRT IN SILICONE
- RUGGED AND DURABLE CONSTRUCTION
- SOFT AND ELASTIC STRAP
- SLIDING ADJUSTMENT SYSTEM

BRAVE JR TT

Code: 411078



- SKIRT IN BI-ELASTOMER WITH EXCLUSIVE TWINTECH TECHNOLOGY
- POLYCARBONATE LENS WITH ANTI-FOG TREATMENT
- SILICONE STRAP
- ADJUSTING BUCKLES



COLOR VARIATIONS



YLACL AQWCL

COLOR VARIATIONS

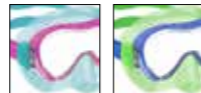

MGAQ BLLM

FITTING



FITTING



PACKAGING



SC

PACKAGING



BX

KEEWEE & KEEWEE JR

Keewee and Keewee Jr. masks are ideal for people who want a streamlined design without compromising comfort.

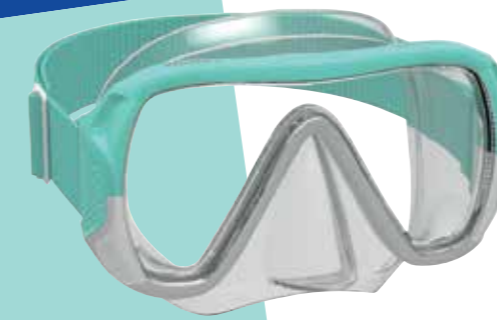

SPECIFICS FOR THE SKIRT

The silicone skirt offers excellent fit and a perfect seal in both versions.



LENS

The field of vision is very wide, thanks to the low-profile frame and shape of the tempered glass lenses.



STRAP

The strap is constructed of an elastic fabric band that is comfortable with long hair or without a hood. It is also easily adjustable due to the sliding buckle.

PIRATE

Code: 411321



- SILICONE SKIRT
- EZ ADJUST BUCKLES ON SKIRT
- WIDE VIEWING ANGLE

VENTO JR

Code: 411240



- SILICONE SKIRT
- EZ ADJUST BUCKLES ON SKIRT
- WIDE DOWNWARDS VIEWING ANGLE



COLOR VARIATIONS



PKWCL RBLCL RYLCL

COLOR VARIATIONS



BLWCL PKWCL

FITTING



FITTING



PACKAGING



SC

PACKAGING



SC

SHARKY JR

Code: 411322



- SILICONE SKIRT
- BUTTON-OPERATED BUCKLES THAT ROTATE ON THE FRAME



BLENNY

Code: 411247



- SILICONE SKIRT
- TWO BUTTON BUCKLE THAT PIVOTS ON FRAME



COLOR VARIATIONS



RBLCL RYLCL RPKCL

COLOR VARIATIONS



YLYL BLBL PKPK

FITTING



FITTING



PACKAGING



BX

PACKAGING



SC

ZEPHIR JR

Code: 411324



- SILITER SKIRT
- EZ ADJUST BUCKLES ON SKIRT
- DURABLE CONSTRUCTION
- WIDE VIEWING ANGLE

SEAHORSE

Code: 411241



- SILITER SKIRT
- EZ ADJUST BUCKLES ON SKIRT
- WIDE DOWNWARDS VIEWING ANGLE



COLOR VARIATIONS



COLOR VARIATIONS



FITTING



FITTING



PACKAGING



GU

PACKAGING



GU

TURTLE

Code: 411249



- SILITER SKIRT
- POLYCARBONATE LENS
- EYELET SYSTEM
- SOFT ELASTIC STRAP

PUFFER

Code: 411248



- SILITER SKIRT
- POLYCARBONATE LENS
- EYELET STRAP SYSTEM



COLOR VARIATIONS



COLOR VARIATIONS



FITTING



FITTING



PACKAGING



SC

PACKAGING



SC



JELLY

Code: 411265



- SILICONE SKIRT
- CURVED PC LENS
- EYELET SYSTEM
- SOFT ELASTIC HEADSTRAP

CARIBE

Code: 411327 - 24 pcs assorted colors (8 x PKCL, BLCL, YLCL)



- SILITER SKIRT
- POLYCARBONATE LENS
- EYELET STRAP SYSTEM

GATOR DRY & GATOR JR DRY

Gator Dry is a snorkel designed and developed entirely at our Headquarters ensuring the utmost functionality and compact size.

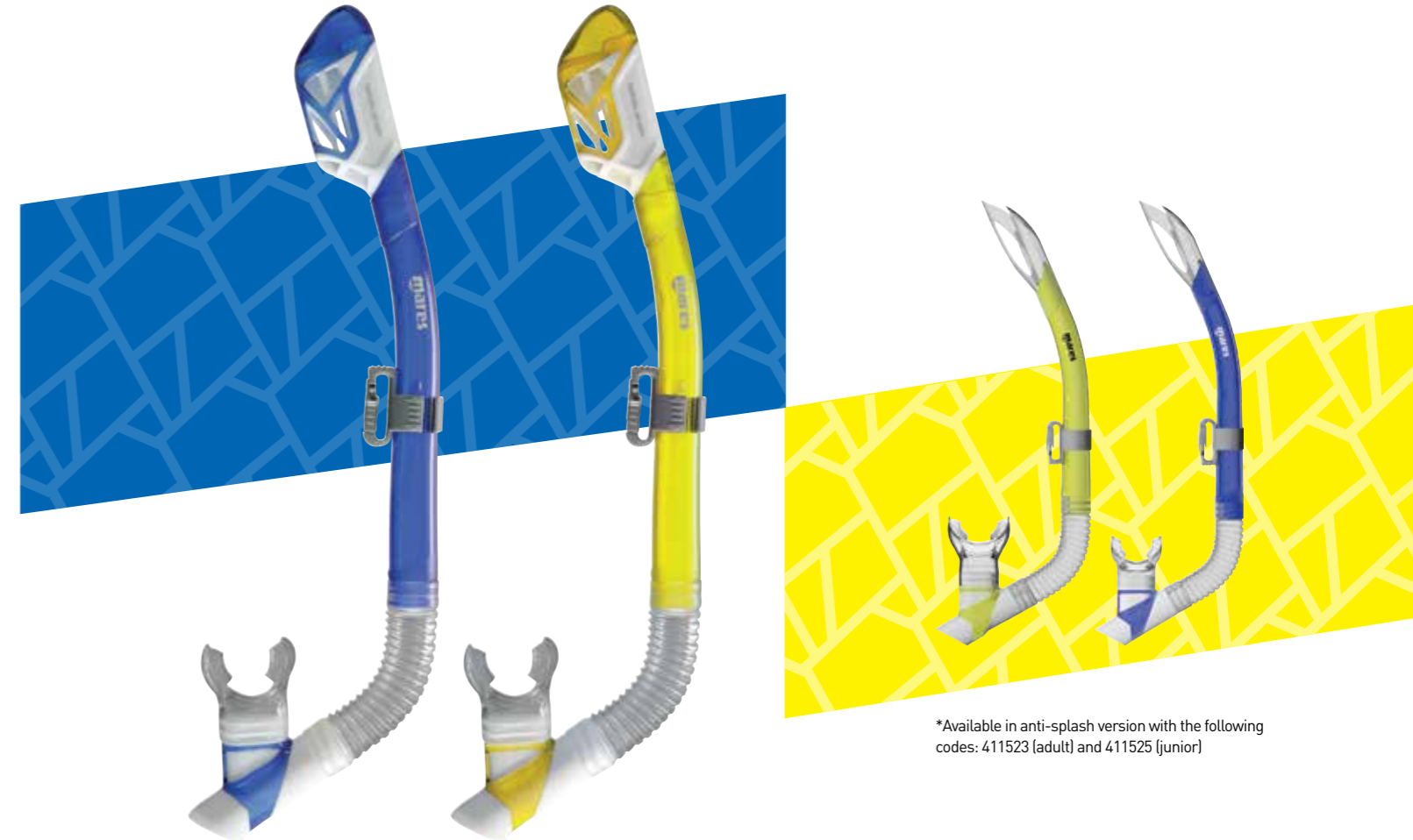

*Available in anti-splash version with the following codes: 411523 (adult) and 411525 (junior)

COLOR VARIATIONS



LMBCL PKYCL

COLOR VARIATIONS



YLCL BLCL PKCL

FITTING



FITTING



PACKAGING



SC

PACKAGING



SC

TOP

The top of the snorkel features an exclusive "dry" valve that prevents water from entering when the top of the snorkel is under water. When submerged the internal mechanism closes, sealing the tube until it resurfaces.

BOTTOM HOUSING

The lower section is fitted with an ultra-comfortable silicone mouthpiece and a purge valve, allowing users to easily clear any residual water that may have entered while snorkeling.

CLIP REGGI-SNORKEL

The snorkel retaining clip has a unique "carabiner" fastening system that's secure and intuitive to use. This makes it easier to connect the snorkel to the mask and prevents it from accidentally detaching.

GATOR DRY

Code: 411522



- DRY TOP
- SLIDING KEEPER WITH CARABINER SYSTEM
- SILICONE MOUTHPIECE
- EXHAUST VALVE



COLOR VARIATIONS



RYL RBL

GATOR SPLASH

Code: 411523



- SEMI-DRY TOP WITH ANTI-SPLASH
- SLIDING KEEPER WITH CARABINER SYSTEM
- SILICONE MOUTHPIECE
- EXHAUST VALVE



COLOR VARIATIONS



RYL RBL

BAY

Code: 411468



- SEMIDRY TOP WITH ANTI-SPLASH
- SLIDING KEEPER
- SILICONE DROP AWAY HOSE AND MOUTHPIECE
- EXHAUST VALVE
- SUITABLE FOR EXTENDED SNORKELING SESSIONS



COLOR VARIATIONS



RYL RBL BKC AQW LIW

SPORT

Code: 411423



- SLIDING KEEPER
- SILICONE MOUTHPIECE



COLOR VARIATIONS



RYL RBL RBK

SAILOR

Code: 411461



- SEMI-DRY TOP WITH ANTI-SPLASH
- SLIDING KEEPER
- SILICONE MOUTHPIECE
- EXHAUST VALVE



COLOR VARIATIONS



BK RBL RYL

ROVER S

Code: 411521



- CURVED, ERGONOMIC STRUCTURE
- INTEGRATED KEEPER
- SILICONE MOUTHPIECE



COLOR VARIATIONS



RYL RBL BK

ROVER PRO

Code: 411519



- CURVED, ERGONOMIC STRUCTURE
- INTEGRATED KEEPER
- EXHAUST VALVE
- SILITER MOUTHPIECE



COLOR VARIATIONS



ROVER

Code: 411518



- CURVED, ERGONOMIC STRUCTURE
- INTEGRATED KEEPER
- SILITER MOUTHPIECE



COLOR VARIATIONS



GATOR JR DRY

Code: 411524



- DRY TOP
- SLIDING KEEPER WITH CARABINER SYSTEM
- SILICONE MOUTHPIECE
- EXHAUST VALVE



COLOR VARIATIONS



GATOR JR SPLASH

Code: 411525



- SEMI-DRY TOP WITH ANTI-SPLASH
- SLIDING KEEPER WITH CARABINER SYSTEM
- SILICONE MOUTHPIECE
- EXHAUST VALVE



COLOR VARIATIONS



MINI RUDDER S

NEW

Code: 411529



- CURVED, ERGONOMIC STRUCTURE
- INTEGRATED KEEPER
- SILICONE MOUTHPIECE



COLOR VARIATIONS



MINI RUDDER

Code: 411520



- CURVED, ERGONOMIC STRUCTURE
- INTEGRATED SNORKEL KEEPER
- SILITER MOUTHPIECE



COLOR VARIATIONS



HIPPO

Code: 411526



- CURVED, ERGONOMIC STRUCTURE
- SOFT SILICONE KEEPER
- SILITER MOUTHPIECE FOR KIDS



COLOR VARIATIONS



MASKS ADULT



	Keewee	Brave TT	Trygon	Wahoo	Pure Vision	Ray	Vento	Ridley	Zephir	Stream	Starfish
Code	411075	411077	411262	411238	411217	411242	411316	411263	411319	411239	411348
Colors	BLWCL MTWCL	BLWCL WHACL	AQWCL BLWCL YLBK	AQWCL RBKBK RBLCL RYLCL	BK7BK BLWCL LWCL YLWCL	BK7BK BLWCL LWCL YLWCL	BK7BK BLWCL LWCL YLWCL	BLWCL PKWCL	BK7BK RBLCL RYLCL	RBLCL RYLCL	BLCL YLBK
Fitting	Adult	Adult	Adult	Adult	Adult	Adult	Adult	Lady/Mid	Adult	Adult	Adult
Silicone Skirt	■	■	■	■	■	■	■	■	■	■	■
TPE Skirt		■									
Tempered Glass Lens	■		■	■	■	■	■	■	■	■	■
Elastic Strap	■										

MASKS JUNIOR



	Keewee Jr	Brave Jr TT	Trygon Jr	Pirate	Vento Jr	Sharky Jr	Blenny	Zephir Jr	Seahorse	Turtle	Puffer	Jelly	Caribe
Code	411076	411078	411264	411321	411240	411322	411247	411324	411241	411249	411248	411265	411327
Colors	AQWCL YLACL	BLLM MGAQ	BLWCL PKWCL	PKWCL RBLCL RYLCL	BLWCL PKWCL	BLWCL RPKCL RYLCL	BLBL PKPK YLYL	RBLCL RPKCL RYLCL	RBLCL RYLCL	AQPK BLGN	AQWCL PKKCL	LMBCL PKYCL	BLBL PKPK YLYL
Fitting	Youth	Youth	Youth	Youth	Youth	Kid	Kid	Youth	Youth	Youth	Kid	Kid	Kid
Silicone Skirt	■		■	■	■	■	■						
TPE Skirt		■											
Tempered Glass Lens	■		■	■	■	■	■	■	■	■			
Elastic Strap	■										■	■	

SNORKELS



	Gator Dry	Gator Splash	Bay	Sailor	Sport	Rover S	Rover Pro	Rover	Gator Jr Dry	Gator Jr Splash	Mini Rudder S	Mini Rudder	Hippo
Code	411522	411523	411468	411461	411423	411521	411519	411518	411524	411525	411529	411520	411526
Colors	RBL RYL	RBL RYL	AQW BK LW RBL RYL	BK RBL RYL	BK RBL RYL	BK RBL RYL	BK RBL RYL	BK RBL RYL	RBL RYL	PK RBL RYL	PK AQ BL	RBL RYL	RAQ RPK
Fitting	Adult	Adult	Adult	Adult	Adult	Adult	Adult	Adult	Junior	Junior	Junior	Junior	Kid
Dry Top	■								■				
Semi Dry Top		■	■	■	■					■			
Silicone Mouthpiece	■	■	■	■	■	■			■	■	■		
Purge Valve	■	■	■	■			■		■	■			



COMBOS
ADULT / JUNIOR



COMBO KEEWEE

Code: 411810



MASK

- SKIRT IN SILICONE
- SOFT AND ELASTIC STRAP
- SLIDING ADJUSTMENT SYSTEM

SNORKEL

- CURVED, ERGONOMIC SHAPE
- BUILT-IN SNORKEL HOLDER
- SILICONE MOUTHPIECE



COLOR VARIATIONS



MTWCL BLWCL

MASK FITTING



PACKAGING



SF

COMBO TRYGON

Code: 411792



MASK

- SILICONE SKIRT
- STURDY, DURABLE CONSTRUCTION
- INTEGRATED BUCKLES ON FRAME

SNORKEL

- SEMI-DRY TOP WITH ANTI-SPLASH
- SLIDING KEEPER
- FLEXIBLE CORRUGATED HOSE
- SILICONE MOUTHPIECE
- EXHAUST VALVE



COLOR VARIATIONS



BLWCL YLBK AQWCL

MASK FITTING



PACKAGING



SF

BUOY BAG

The Buoy Bag is the latest arrival in the Aquazone packaging. The packaging is reusable and serves multiple functions, representing an added value for the end consumer.

THE PACKAGING FUNCTION
The buoy bag guarantees excellent product visibility in the store, with a clear broad front panel. It comes with a header card graphically illustrating the many ways to use it.

ACCESSORY FUNCTIONS
It can be used for carrying snorkeling equipment, or to stow personal objects on the beach, protecting them from water and sand. The valve lets you blow up the inner air chamber, transforming the sack into a comfortable beach cushion, or into a buoy for swimming and snorkeling in open water. The shoulder strap, with its quick-release buckle, functions as a belt to fasten around your waist when playing in the water. Finally, it can also be used to collect garbage on the beach.

AVAILABILITY
The Buoy Bag is available with the Wahoo Neon (code 411779) and Pirate Neon (code 411788) combos, in the BB size.

multifunctional BAG

- 1 carry BAG
- 2 swimming-snorkeling MARKER
- 3 inflatable CUSHION
- 4 Environment CLEAN-UP bag

COMBO RAY

Code: 411759



MASK

- SILICONE SKIRT
- STURDY AND DURABLE CONSTRUCTION
- INTEGRATED BUCKLES ON FRAME

SNORKEL

- SEMIDRY TOP WITH ANTI-SPLASH
- SLIDING KEEPER
- SILICONE CORRUGATED HOSE AND MOUTHPIECE
- EXHAUST VALVE



COLOR VARIATIONS



YLWCL BLWCL

MASK FITTING



PACKAGING



SF

COMBO WAHOO NEON

Code: 411779



MASK

- SILICONE SKIRT
- ELASTIC HEADSTRAP FIXED ON THE SKIRT
- SLIDING ADJUSTMENT SYSTEM
- WIDE VIEWING ANGLE

SNORKEL

- SEMIDRY TOP WITH ANTI-SPLASH
- SLIDING KEEPER
- CORRUGATED SILICONE HOSE AND MOUTHPIECE
- EXHAUST VALVE



COLOR VARIATIONS



YLWCL PKWCL

MASK FITTING



PACKAGING



SF

BB*

* Only available with YLWCL

COMBO WAHOO

Code: 411745



MASK

- SILICONE SKIRT
- EZ ADJUST BUCKLES ON SKIRT
- DURABLE CONSTRUCTION
- WIDE VIEWING ANGLE

SNORKEL

- SEMIDRY TOP WITH ANTI-SPLASH
- SLIDING KEEPER
- SILICONE MOUTHPIECE
- EXHAUST VALVE



COLOR VARIATIONS



RYLCL RBLCL AQWCL

MASK FITTING



PACKAGING



SF

COMBO PURE VISION

Code: 411736



MASK

- SILICONE SKIRT
- EZ ADJUST BUCKLES ON SKIRT
- WIDE VIEWING ANGLE

SNORKEL

- SEMIDRY TOP WITH ANTI-SPLASH
- SLIDING KEEPER
- SILICONE MOUTHPIECE
- EXHAUST VALVE



COLOR VARIATIONS



RBLCL RYLCL

MASK FITTING



PACKAGING



SF

COMBO VENTO

Code: 411746



MASK

- SILICONE SKIRT
- EZ ADJUST BUCKLES ON SKIRT
- WIDE DOWNWARD VIEWING ANGLE

SNORKEL

- SLIDING KEEPER
- SILICONE MOUTHPIECE



COLOR VARIATIONS



RYLCL RBLCL

MASK FITTING



PACKAGING



SF

COMBO TROPICAL

Code: 411776



MASK

- FRAMELESS SILICONE MASK
- ULTRA COMFORTABLE SKIRT
- STURDY BUCKLES ON SKIRT

SNORKEL

- SEMI-DRY TOP WITH ANTI-SPLASH
- SLIDING KEEPER
- SILICONE MOUTHPIECE
- EXHAUST VALVE



COLOR VARIATIONS



BLBL WHWH PKPK

MASK FITTING



PACKAGING



SF

COMBO RIDLEY

Code: 411793



MASK

- MEDIUM SIZED SILICONE SKIRT
- EZ ADJUST BUCKLE ON SKIRT

SNORKEL

- SEMI-DRY TOP WITH ANTI-SPLASH
- SLIDING KEEPER WITH CARABINER SYSTEM
- SILICONE MOUTHPIECE
- EXHAUST VALVE



COLOR VARIATIONS



BLWCL PKWCL

MASK FITTING



PACKAGING



SF

COMBO TANA

Code: 411734



MASK

- SILICONE SKIRT
- LOW INTERNAL VOLUME
- BUCKLES ON SKIRT

SNORKEL

- BI-MATERIAL SNORKEL
- CURVED, ERGONOMIC STRUCTURE
- SLIDING KEEPER
- SILICONE MOUTHPIECE FOR EXTENDED USE



COLOR VARIATIONS



BKBK

MASK FITTING



PACKAGING



HP

COMBO ZEPHIR

Code: 411769



MASK

- SILITER SKIRT
- EZ ADJUST BUCKLES ON SKIRT
- WIDE VIEWING ANGLE

SNORKEL

- CURVED, ERGONOMIC STRUCTURE
- INTEGRATED KEEPER
- EXHAUST VALVE
- SILITER MOUTHPIECE



COLOR VARIATIONS



RYLCL RBLCL

MASK FITTING



PACKAGING



GU

COMBO STREAM

Code: 411770



MASK

- SILITER SKIRT
- EZ ADJUST BUCKLES ON SKIRT
- WIDE DOWNWARD VIEWING ANGLE

SNORKEL

- CURVED, ERGONOMIC STRUCTURE
- INTEGRATED KEEPER
- EXHAUST VALVE
- SILITER MOUTHPIECE



COLOR VARIATIONS



RYLCL RBLCL

MASK FITTING



PACKAGING



GU

COMBO STARFISH

Code: 411740



MASK

- SILITER SKIRT
- PIVOTING BUCKLES ON FRAME

SNORKEL

- CURVED, ERGONOMIC STRUCTURE
- INTEGRATED KEEPER
- SILITER MOUTHPIECE



COLOR VARIATIONS



RBLCL YLBK

MASK FITTING



PACKAGING



GU

COMBO KEEWEE JR

Code: 411811



MASK

- SKIRT IN SILICONE
- SOFT AND ELASTIC STRAP
- SLIDING ADJUSTMENT SYSTEM

SNORKEL

- CURVED, ERGONOMIC SHAPE
- BUILT-IN SNORKEL HOLDER
- SILICONE MOUTHPIECE



COLOR VARIATIONS



YLACL AQWCL

MASK FITTING



PACKAGING



SF

COMBO TRYGON JR

Code: 411794



MASK

- SILICONE SKIRT
- STURDY, DURABLE CONSTRUCTION
- INTEGRATED BUCKLES ON FRAME

SNORKEL

- SEMI-DRY TOP WITH ANTI-SPLASH
- SLIDING KEEPER WITH CARABINER SYSTEM
- SILICONE MOUTHPIECE
- EXHAUST VALVE



COLOR VARIATIONS



PKWCL

BLWCL

MASK FITTING



PACKAGING



SF

COMBO PIRATE NEON

Code: 411788



MASK

- SILICONE SKIRT
- ELASTIC HEADSTRAP FIXED ON THE SKIRT
- SLIDING ADJUSTMENT SYSTEM
- WIDE VIEWING ANGLE

SNORKEL

- SEMIDRY TOP WITH ANTI-SPLASH
- SLIDING KEEPER
- SILICONE MOUTHPIECE
- EXHAUST VALVE



COLOR VARIATIONS



PKWCL

YLWCL

MASK FITTING



PACKAGING



SF



BB*

* Only available with YLWCL

COMBO PIRATE

Code: 411757



MASK

- SILICONE SKIRT
- ELASTIC HEADSTRAP FIXED ON THE SKIRT
- SLIDING ADJUSTMENT SYSTEM
- WIDE VIEWING ANGLE

SNORKEL

- SEMIDRY TOP WITH ANTI-SPLASH
- SLIDING KEEPER
- SILICONE MOUTHPIECE
- EXHAUST VALVE



COLOR VARIATIONS



RBLCL

PKWCL

MASK FITTING



PACKAGING



SF

COMBO VENTO ENERGY JR

Code: 411774



MASK

- SILICONE SKIRT
- EZ ADJUST BUCKLES ON SKIRT
- WIDE DOWNWARD VIEWING ANGLE

SNORKEL

- CURVED
- ERGONOMIC STRUCTURE
- INTEGRATED KEEPER
- SILICONE MOUTHPIECE



COLOR VARIATIONS



OCTCL

MASK FITTING



PACKAGING



SF

COMBO SHARKY

Code: 411729



MASK

- SILICONE SKIRT
- ADJUSTING BUCKLES ON FRAME

SNORKEL

- SEMIDRY TOP WITH ANTI-SPLASH
- SLIDING KEEPER
- SILITER MOUTHPIECE
- EXHAUST VALVE

COMBO BLENNY

Code: 411777



MASK

- SILICONE SKIRT
- TWO BUTTON BUCKLE THAT PIVOTS ON FRAME

SNORKEL

- SEMIDRY TOP WITH ANTISPLASH
- SLIDING KEEPER
- SILICONE MOUTHPIECE
- EXHAUST VALVE



COLOR VARIATIONS



RBLCL RPKCL

COLOR VARIATIONS



BLBL PKPK

MASK FITTING



MASK FITTING



PACKAGING



SF

PACKAGING



SF

DILLY

Dilly is our most comfortable Kid Combo. It is designed to be easily worn by children from 4 to 7, and not just for snorkeling. It's also a helpful tool in developing and improving their skills in the water.



SPECIFICS FOR THE SKIRT

The little mask features an incredibly soft elastomer skirt and frame. Adapting to the shapes of the face, creating a watertight seal without uncomfortable pressure or tension.



STRAP

The strap is made of a soft elastic fabric band that is easy for children to adjust thanks to the sliding buckle.



LENS

The lens, in cellulose propionate, is also incredibly flexible: This is another important element in ensuring a super snug and comfortable fit with complete safety.



SNORKEL

The lightweight curved snorkel and specific mouthpiece prevents jaw fatigue by adapting perfectly to this age range of users. The snorkel can be fastened to the mask with the soft silicone snorkel holder.

COMBO DILLY

Code: 411795



MASK

- SUPER SOFT, COMFORTABLE TPE SKIRT
- ULTRA FLEXIBLE CP* LENS
- SLIDING BUCKLE, EASILY ADJUSTABLE FOR KIDS
- SOFT ELASTIC STRAP, NO HAIR TANGLING

SNORKEL

- CURVED ERGONOMIC STRUCTURE
- SOFT SILICONE KEEPER
- SILITER MOUTHPIECE

COMBO JELLY

Code: 411797



MASK

- SILITER SKIRT
- CURVED PC LENSE
- EYELET SYSTEM
- SOFT ELASTIC STRAP

SNORKEL

- CURVED, ERGONOMIC STRUCTURE
- SOFT SILICONE KEEPER
- SILITER MOUTHPIECE FOR KIDS



COLOR VARIATIONS



YLPK BLAQ

COLOR VARIATIONS



LMBCL PKYCL

MASK FITTING



MASK FITTING



PACKAGING



GU

PACKAGING



GU

* Cellulose-Proprionate

COMBO ZEPHIR JR

Code: 411730



MASK

- SILITER SKIRT
- EZ ADJUST BUCKLES ON SKIRT
- DURABLE CONSTRUCTION
- WIDE VIEWING ANGLE

SNORKEL

- CURVED ERGONOMIC STRUCTURE
- INTEGRATED SNORKEL KEEPER
- SILITER MOUTHPIECE



COMBO SEAHORSE

Code: 411749



MASK

- SILITER SKIRT
- EZ ADJUST BUCKLES ON SKIRT
- WIDE DOWNWARD VIEWING ANGLE

SNORKEL

- CURVED ERGONOMIC STRUCTURE
- INTEGRATED SNORKEL KEEPER
- SILITER MOUTHPIECE



COLOR VARIATIONS



RYLCL RBLCL RPKCL

COLOR VARIATIONS



RBLCL RPKCL RYLCL

MASK FITTING



MASK FITTING



PACKAGING



GU

PACKAGING



GU



COMBO TURTLE

Code: 411778



MASK

- SILITER SKIRT
- POLYCARBONATE LENS
- EYELET SYSTEM
- SOFT ELASTIC STRAP

SNORKEL

- BASIC CONSTRUCTION
- SILITER MOUTHPIECE

COLOR VARIATIONS



PACKAGING



GU



MASK FITTING



COMBO ADULT



	Keewee	Trygon	Ray	Wahoo Neon	Wahoo	Pure Vision	Vento	Tropical	Ridley	Tana	Zephir	Stream	Starfish
Code	411810	411792	411759	411779	411745	411736	411746	411776	411793	411734	411769	411770	411740
Colors	BLWCL MTWCL	AQWCL BLWCL YLBK	BLWCL YLWCL	PKWCL YLWCL	AQWCL RBLCL RYLCL	RBLCL RYLCL	RBLCL RYLCL	BLBL PKPK WHWH	BLWCL PKWCL	BKKBK	RBLCL RYLCL	RBLCL RYLCL	RBLCL YLBK
Fitting	Adult	Adult	Adult	Adult	Adult	Adult	Adult	Adult	Lady/Mid	Adult	Adult	Adult	Adult
Silicone Skirt	■	■	■	■	■	■	■	■	■	■	■	■	■
Tempered Glass Lens	■	■	■	■	■	■	■	■	■	■	■	■	■
Silicone Mouthpiece	■	■	■	■	■	■	■	■	■	■	■	■	■
Purge Valve		■	■	■	■	■	■	■	■		■	■	
Elastic Strap	■			■									

COMBO JUNIOR



	Keewee Jr	Trygon Jr	Pirate Neon	Pirate	Vento Energy Jr	Sharky	Blenny	Dilly	Jelly	Zephir Jr	Seahorse	Turtle
Code	411811	411794	411788	411757	411774	411729	411777	411795	411797	411730	411749	411778
Colors	AQWCL YLACL	BLWCL PKWCL	PKWCL YLWCL	PKWCL RBLCL	OCTCL	RBLCL RPKCL	BLBL PKPK	BLAQ YLPK	LMBCL PKYCL	RBLCL RPKCL RYLCL	RBLCL RPKCL RYLCL	AQPK BLGN
Fitting	Youth	Youth	Youth	Youth	Youth	Kid	Kid	Kid	Kid	Youth	Youth	Youth
Silicone Skirt	■	■	■	■	■	■	■	■	■			
TPE Skirt								■				
Tempered Glass Lens	■	■	■	■	■	■	■			■	■	
CP Lens*								■				
Semi dry top		■	■	■		■	■					
Silicone Mouthpiece	■	■	■	■	■	■	■	■	■	■	■	■
Purge Valve		■	■	■		■	■			■	■	
Elastic Strap	■		■					■	■			■

* Cellulose-Propionate



SETS

ADULT / JUNIOR



SET NATEEVA KEEWEE

Code: 410757



MASK

- SKIRT IN SILICONE
- SOFT AND ELASTIC STRAP
- SLIDING ADJUSTMENT SYSTEM

SNORKEL

- CURVED, ERGONOMIC SHAPE
- BUILT-IN SNORKEL HOLDER
- SILICONE MOUTHPIECE

FINS

- ADJUSTS USING A STRAP WITH NO BUCKLES
- ULTRA-COMFORTABLE FOOT POCKET
- SYSTEM TO FASTEN FINS TOGETHER FOR EASIER TRANSPORT



COLOR VARIATIONS



FIN SIZE CHART

Sizes	EU	UK	USA
SM	35/38	2.5/5	3.5/6
ML	39/43	5.5/9	6.5/10
LXL	44/47	9.5/12	10.5/13

FITTING

	SM	ML	LXL
WHITE (WH)	■	■	
BLUE (BL)	■	■	■

MASK FITTING



PACKAGING



SET X-ONE MAREA

Code: 410794



MASK

- SILICONE SKIRT
- SMALL RIBS AROUND NOSE TO RELIEVE PRESSURE
- EZ ADJUST BUCKLES ON SKIRT
- WIDE DOWNWARD VIEWING ANGLE

SNORKEL

- SEMIDRY TOP WITH ANTISPLASH
- SILICONE MOUTHPIECE
- EXHAUST VALVE

FINS

- BUCKLE-FREE STRAP REGULATION
- RIDDLED FOOT POCKET AVOIDS PARACHUTE EFFECT
- TRAVEL FRIENDLY BLADE WITH CHANNEL THRUST



COLOR VARIATIONS



FIN SIZE CHART

Sizes	EU	UK	USA
SM	35/38	2.5/5	3.5/6
ML	39/43	5.5/9	6.5/10
LXL	44/47	9.5/12	10.5/13

MASK FITTING



PACKAGING



SET NATEEVA KEEWEE JR

Code: 410758



MASK

- SKIRT IN SILICONE
- SOFT AND ELASTIC STRAP
- SLIDING ADJUSTMENT SYSTEM

SNORKEL

- CURVED, ERGONOMIC SHAPE
- BUILT-IN SNORKEL HOLDER
- SILICONE MOUTHPIECE

FINS

- ADJUSTS USING A STRAP WITH NO BUCKLES
- ULTRA-COMFORTABLE FOOT POCKET
- SYSTEM TO FASTEN FINS TOGETHER FOR EASIER TRANSPORT



SET X-ONE PIRATE

Code: 410759



MASK

- SILICONE SKIRT
- EASY ADJUST BUCKLES ON SKIRT
- WIDE VIEWING ANGLE

SNORKEL

- SEMI DRY TOP WITH ANTI-SPLASH
- SILICONE MOUTHPIECE
- EXHAUST VALVE

FIN

- BUCKLE-FREE STRAP DESIGN
- RIDDLED FOOT POCKET AVOIDS PARACHUTE EFFECT
- TRAVEL FRIENDLY SHORT BLADE
- CHANNEL THRUST TECHNOLOGY



NEOPRENE

ADULT / JUNIOR

COLOR VARIATIONS



AQ

BL

PACKAGING



SP

MASK FITTING



FIN SIZE CHART

Sizes	EU	UK	USA
XS	30/34	11.5/2	12.5/3

COLOR VARIATIONS



BL

PK

PACKAGING



TB

MASK FITTING



FIN SIZE CHART

Sizes	EU	UK	USA
XS	24/29	7/10.5	7.5/11
S	30/34	11.5/2	12/3



STEAMER MANTA

Code: 412456 Man

Code: 412457 Lady

- DOUBLE LINING
- BACK ZIP
- ZIP PULL AND LOCKING SYSTEM
- RUBBERIZED KNEE PADS
- COLORED BACK PANEL FOR GREATER VISIBILITY IN THE WATER



TECHNICAL FEATURES

Thickness	2.2mm						
Fabric Type	Neoprene						
Sizes Man	1	2	3	4	5	6	7
Sizes Lady	1	2	3	4	5		

SIZE CHART

MANTA / MAN

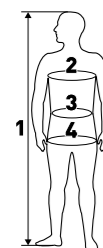

IT	1	2	3	4	5	6	7	8
EU	XS	S	M	ML	L	XL	2XL	3XL
USA		S	M	L	XL	XXL	XXXL	
1	173 / 5'7"	176 / 5'9"	179 / 5'10"	182 / 6"	185 / 6'1"	188 / 6'2"	191 / 6'3"	194 / 6'4"
2	88.5 / 35"	92 / 36"	96.5 / 38"	100.5 / 40"	105 / 41"	109 / 43"	113.5 / 45"	117.5 / 46"
3	67.5 / 27"	71.5 / 28"	75.5 / 30"	80 / 32"	84 / 33"	88.5 / 35"	92.5 / 36"	97 / 38"
4	87 / 34"	91 / 36"	95 / 37"	99.5 / 39"	103.5 / 41"	108 / 43"	112 / 44"	116 / 46"

MANTA / LADY



IT	1	2	3	4	5
EU	XS	S	M	L	XL
USA	4	6	8	10	12
1	163 / 5'4"	166 / 5'6"	169 / 5'7"	172 / 5'8"	175 / 5'9"
2	75 / 30"	79 / 31"	83 / 33"	87 / 34"	91 / 36"
3	66 / 26"	70 / 28"	74 / 29"	78 / 31"	82 / 32"
4	82 / 32"	86 / 34"	90 / 36"	94 / 37"	98 / 39"

SHORTY MANTA

Code: 412458 Man

Code: 412459 Lady

- DOUBLE LINING
- BACK ZIP
- ZIP PULL AND LOCKING SYSTEM



SHORTY MANTA JUNIOR

Code: 412460

- DOUBLE LINING
- BACK ZIP
- ZIP PULL AND LOCKING SYSTEM

TECHNICAL FEATURES

Thickness	2.2mm						
Fabric Type	Neoprene						
Sizes Man	1	2	3	4	5	6	7
Sizes Lady	1	2	3	4	5		

TECHNICAL FEATURES

Thickness	2.2mm						
Fabric Type	Neoprene						
Sizes	-6	-5	-4	-3	-2	-1	0
Ages*	4-6	6-7	7-8	8-9	9-10	10-11	12-13

* Ages indicated in the table are purely for reference

BABY WRAP

Code: 412557



- THE FIRST NEOPRENE SUIT FOR BABIES
- THERMAL COMFORT
- EASY TO WEAR
- 4 STRAPS WITH VELCRO® BRAND LOOP-AND-HOOK CLOSURE SYSTEM
- EASY ACCESS FOR DIAPER CHANGING



BL

PK

FLOATING JACKET

Code: 412589 - 1 piece per size/color



- NOT A LIFE JACKET. DOES NOT PROTECT AGAINST DROWNING
- AID FOR LEARNING TO SWIM, CERTIFIED IN COMPLIANCE WITH EN 13138-1:2014
- INNER ANTI-PUNCTURE FOAM FLOATERS
- ALLOWS A PROGRESSIVE BUOYANCY REDUCTION
- DOUBLE LINED NEOPRENE
- FRONT ZIP WITH SECURITY PAD
- CROTCH BAND WITH SECURITY BUCKLE



LM



PK



TECHNICAL FEATURES

Fabric Type	Neoprene		
Sizes	S	M	L
Ages*	6 - 12	12 - 18	18 - 24
Weight (kg)	7 - 13	10 - 17	14 +
Height (cm)	75	80	90

TECHNICAL FEATURES

Fabric Type	Neoprene			
Sizes	XXS	XS	S	M
Weight (kg)	< 11	11 - 15	15 - 18	18 - 30

* Ages indicated in the table are purely for reference



23



DIVING CENTER



ROVER 15X

Code: **416254 INT / DIN 300**



- 2ND STAGE
- EASY-TO-USE PURGE BUTTON WITH DYNAMIC HINGE DESIGN
 - VAD SYSTEM WITH FLUID DYNAMIC DEFLECTOR
 - MID-SIZE
 - OVERSIZED PURGE BUTTON
 - RUBBER HOSE

- 1ST STAGE
- DFC PORT
 - PRE-ORIENTED PORTS
 - COMPACT SIZE
 - SANDBLASTED FINISH



TECHNICAL FEATURES

		INT	DIN 300 bar
1st Stage	Type		
	Weight	772g / 27.2oz	598g / 21.1oz
	High pressure ports	2 HP 7/16" UNF	
Low pressure ports		4 LP 3/8" UNF	
2nd Stage	Weight	190g / 6.7oz	
	Material / Technology	Ultralight Technopolymer	
	LP Hose Type/Length	Rubber hose / 80cm	
Total weight (including hose)		1107g / 39oz	933g / 32.9oz

OCTOPUS ROVER

Code: **416557 NR**

Code: **416584 NR - DC Pack (MOQ 6pcs)**



- EASY-TO-USE PURGE BUTTON WITH DYNAMIC HINGE DESIGN
- VAD SYSTEM WITH FLUID DYNAMIC DEFLECTOR
- MID-SIZE
- OVERSIZED PURGE BUTTON
- RUBBER HOSE

ROVER 2S

Code: **416255 INT / DIN 300**

Code: **416266 - DC Pack (MOQ 6pcs)**



- 2ND STAGE
- EASY-TO-USE PURGE BUTTON WITH DYNAMIC HINGE DESIGN
 - VAD SYSTEM WITH FLUID DYNAMIC DEFLECTOR
 - MID-SIZE
 - OVERSIZED PURGE BUTTON
 - RUBBER HOSE

- 1ST STAGE*
- LIGHTWEIGHT, STURDY AND COMPACT
 - PISTON CONTROL
 - DEDICATED PLACE FOR RFID CHIP



TECHNICAL FEATURES

		INT	DIN 300 bar
1st Stage	Type		
	Weight	608g / 21.4oz	432g / 15.2oz
	High pressure ports	1 HP 7/16" UNF	
Low pressure ports		4 LP 3/8" UNF	
2nd Stage	Weight	190g / 6.7oz	
	Material / Technology	Ultralight Technopolymer	
	LP Hose Type/Length	Rubber hose / 80cm	
Total weight (including hose)		977g / 34.5oz	978g / 34.5oz

TECHNICAL FEATURES

2nd Stage	Weight	190g / 6.7oz
	Material / Technology	Ultralight Technopolymer
	LP Hose Type /Length	Rubber hose/ 100cm
Total weight (including hose)		365g / 12.8 oz



1ST STAGE 15X*

Code: **416237 INT /DIN 300**

- DFC PORT
- PRE-ORIENTED PORTS
- SANDBLASTED FINISH



TECHNICAL FEATURES

		INT	DIN 300 bar
1st Stage	Type		
	Weight	772g / 27.2oz	598g / 21.1oz
	High pressure ports	2 HP 7/16" UNF ports	
Low pressure ports		4 LP 3/8" UNF ports	

AST DRY SYSTEM

Code: **416811 INT**

Code: **416812 DIN**

- AUTO-SEALING TECHNOLOGY
- KEEPS THE FIRST STAGE DRY
- ACTIVATED BY GAS
- CAN BE USED WITH A HIGHER PERCENTAGE OF OXYGEN
- CAN BE USED IN COLD WATER
- CAN BE INSTALLED ON 15X AND 2S 1ST STAGES



MOUTHPIECE KIT

Code: **415345**

- BLACK
- FITS ON ALL MARES REGULATORS
- 20 PCS STANDARD + 10 PCS SMALL + 30 CLAMPS



1ST STAGE 2S*

Code: **416232 INT /DIN 300**

- LIGHTWEIGHT, STURDY AND COMPACT
- PISTON CONTROL
- DEDICATED PLACE FOR RFID CHIP



TECHNICAL FEATURES

		INT	DIN 300 bar
1st Stage	Type		
	Weight	608g / 21.4oz	432g / 15.2oz
	High pressure ports	1 HP 7/16" UNF port	
Low pressure ports		4 LP 3/8" UNF ports	

15X-2S DIN CONNECTOR

Code: **416809**

- FOR 200 AND 300 BAR USE
- CONICAL SINTERED FILTER



* Not to scale
Mares regulators have been tested and certified in compliance with EC directive 89/686/EEC and/or European Regulation 2016/425 according to the EN 250: 2014 standard.

* For use with octopuses and second stages with which it has been certified. Assembly, checks and any necessary adjustments must be done by a Mares Lab Authorized Service Center.

DIVING CENTER / BCD LINE

- UV PROTECTED 1000 DENIER CORDURA®
- STANDARD BUCKLE WEIGHT SYSTEM (OPTIONAL - ROVER PRO DC)
- HEIGHT ADJUSTABLE SHOULDER BUCKLES
- SPECIALLY DESIGNED OCTOPUS AND PRESSURE GAUGE POCKETS
- BACKPACK WITH HANDLE TO CARRY EASILY
- ADJUSTABLE CUMMERBUND
- HIGH BUOYANCY LIFT
- COLOR & SIZE IDENTIFICATION



Color & Size identification



Flat Ergo inflator



Backpack



Trim Weights

ROVER PRO DC

Code: 417366



Standard buckle weight system (optional)

TECHNICAL FEATURES

Sizes	XXS	XS	S	M	L	XL	2XL
Weight	3,1kg / 6.8lb	3,1kg / 6.8lb	3,2kg / 7.0lb	3,3kg / 7.2lb	3,3kg / 7.2lb	3,4kg / 7.5lb	3,4kg / 7.5lb
Buoyancy	140 N (14,2kg / 31.3lb)	140 N (14,2kg / 31.3lb)	150 N (16kg / 35lb)	160 N (16,3kg / 35.9lb)	200 N (21kg / 46lb)	230 N (23,5kg / 51.7lb)	240 N (24,5kg / 54lb)

ROVER DC

Code: 417342



TECHNICAL FEATURES

Sizes	XXS	XS	S	M	L	XL	2XL
Weight	2,7kg / 5.9lb	2,7kg / 5.9lb	2,9kg / 6.4lb	3,0kg / 6.6lb	3,0kg / 6.6lb	3,1kg / 6.8lb	3,1kg / 6.8lb
Buoyancy	140 N (14,2kg / 31.3lb)	140 N (14,2kg / 31.3lb)	150 N (16kg / 35lb)	160 N (16,3kg / 35.9lb)	200 N (21kg / 46lb)	230 N (23,5kg / 51.7lb)	240 N (24,5kg / 54lb)

TRIM WEIGHT

Code: 417964 - (PAIR)

- EASY TO INSTALL ON TANK BAND
- DOUBLE LOOP TO FIT PERFECTLY ON THE BAND
- PERFECT BUOYANCY
- LESS WEIGHT ON THE BELT
- WEIGHT CAPACITY: 2kg EACH



STANDARD WEIGHT SYSTEM

Code: 417968 - SMALL: 4kg / 9lbs (PAIR)

Code: 417967 - LARGE: 6kg / 13lbs (PAIR)

- ADD-ON TO UPGRADE BCD WITH STANDARD BUCKLE WEIGHT SYSTEM
- ZIPPERED POCKET
- EASY USE WITH THICK GLOVES





mares | 
diving center



DIVING CENTER LINE

Years of research and development combined with experience and feedback from our Diving Centers around the world, have all contributed to the creation of the Mares Diving Center project. A line of products and support services designed specifically with the most demanding Diving Centers in mind. Mares' guarantee and experience delivers the high quality standard required by every Diving Center.



ROVER LINE

The diving center market is an extremely important part of the diving business. Mares supports this market with a dedicated product line. Careful attention was paid to the durability, functionality and comfort of the Rover line. It is a dedicated product line, including regulators, bc-vests, wetsuits and masks developed to meet the special needs of DC customers.



SIZE
COLOR & SIZE

Mares found a solution to help you in your daily business; by introducing a new quick and easy Color & Size identification system on many products. This system will allow you and your staff to immediately identify the different sizes in your Diving Center and rental equipment just by looking at the color codes.

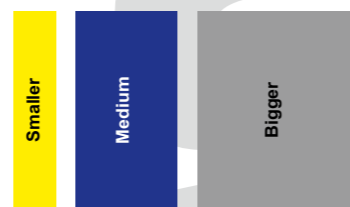
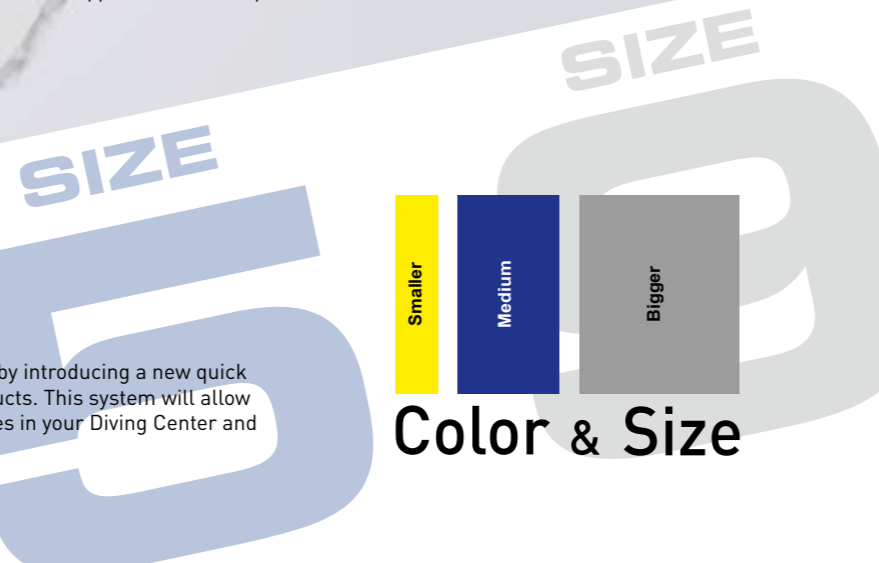

Color & Size



Many thanks to Sea Star Belize for their valuable support in making our Belize photoshoot a great success!

www.seastarbelize.com

mares | 
diving center

SSI SCUBA
SCHOOLS
INTERNATIONAL

DIVING CENTER / WETSUIT LINE

- PERFECT FIT AND FREEDOM OF MOVEMENT
- EXTRA LONG FRONT ZIPPER FOR EASIER DONNING AND DOFFING
- POLYURETHANE PROTECTION ON THE AREAS SUBJECT TO THE GREATEST WEAR
- ZIPS AT THE ANKLES
- HOOD WITH TWO HOLES FOR VENTING TRAPPED AIR
- WIDE FACE OPENING FOR GREATER COMFORT
- MANUFACTURED ENTIRELY IN ULTRASTRETCH MATERIAL
- ALSO AVAILABLE IN CHILDREN'S SIZES, FROM -3 TO 0
- VERY LARGE SIZES, +8 AND +9
- COLOR & SIZE IDENTIFICATION SYSTEM



Color & Size identification system

Extra Long Front Zipper

PU protection

ROVER OVERALL WITH HOOD

Code: 412381 - 7 mm

Code: 412377 - 5 mm

Code: 412378 - 5 mm She Dives

Code: 412430 - 7 mm She Dives



TECHNICAL FEATURES

Thickness	7.0 mm / 5.0 mm												
Fabric type	Ultrastretch Neoprene												
Sizes	-3	-2	-1	0	1	2	3	4	5	6	7	8	9

TECHNICAL FEATURES

Thickness	7.0 mm / 5.0 mm												
Fabric type	Ultrastretch Neoprene												
She Dives Sizes						2	3	4					

ROVER OVERALL HOODLESS

Code: 412379 - 5 mm

Code: 412380 - 3 mm



TECHNICAL FEATURES

Thickness	5.0 mm / 3.0 mm												
Fabric type	Ultrastretch Neoprene												
Sizes	-3	-2	-1	0	1	2	3	4	5	6	7	8	9

ROVER HOOD

Code: 412813



TECHNICAL FEATURES

Thickness	5.0 mm		
Fabric type	Ultrastretch Neoprene		
Sizes	S	M	L

ROVER SHORTY

Code: 412388



TECHNICAL FEATURES

Thickness	3.0 mm												
Fabric type	Ultrastretch Neoprene												
Sizes	-3	-2	-1	0	1	2	3	4	5	6	7	8	9

DIVING CENTER / SIZE GUIDE CHART

412381 / 412377 / 412379 / 412380 / 412388 - ROVER UNISEX

COLOR&SIZE	EU SIZE	MAN SIZE	LADY SIZE	KIDS	HEIGHT
-3				8 years	128-134
-2			32	10 years	140
-1			32L	12 years	152
0			34/36	14 years	164
1	XS	44	36/38		170
2	S	46	38/40		173
3	M	46/48	40/42		176
4	L	48/50	44/46		179
5	XL	50/52	48/50		182
6	XXL	52/54			185
7	3XL	54/56			188
8	4XL	56/58			191
9	5XL	58/60			194

412378 / 412430 - ROVER SHE DIVES

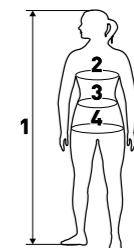

IT	2	3	4
EU	S	M	L
USA	6	8	10
1	167 / 5'6"	170 / 5'7"	173 / 5'8"
2	81,5 / 32"	85,5 / 34"	89,5 / 35"
3	71 / 28"	75 / 30"	79 / 31"
4	88 / 35"	92 / 36"	96 / 38"

RASH GUARD

- PERFECT AS AN UNDERSUIT AND SKIN PROTECTION
- IDEAL FOR ALL WATERSPORTS ACTIVITIES
- MALE AND FEMALE VERSIONS
- FLATLOCK STITCHED SEAMS
- IDEAL FOR DC STAFF IDENTIFICATION



MAN

- Code: 412416 - Rash Guard Short Sleeve
- Code: 412421 - Rash Guard Long Sleeve
- Code: 412547 - Shorts



SHE DIVES

- Code: 412417 - Rash Guard Short Sleeve
- Code: 412422 - Rash Guard Long Sleeve
- Code: 412548 - Shorts



TECHNICAL FEATURES

Fabric	Polyester/Spandex						
Short Sleeve	S	M	L	XL	2XL	3XL	
Long Sleeve	S	M	L	XL	2XL	3XL	
Shorts	XS	S	M	L	XL	2XL	3XL

TECHNICAL FEATURES

Fabric	Polyester/Spandex						
Short Sleeve	XS	S	M	L	XL	2XL	
Long Sleeve	XS	S	M	L	XL		
Shorts	XXS	XS	S	M	L	XL	2XL

ROVER

Code: 411243

- INTEGRATED BUCKLES
- WIDER RANGE OF FITTING
- STURDY AND DURABLE CONSTRUCTION
- SILICONE SKIRT



COLOR VARIATIONS



ROVER MASKS & SNORKEL SET

Code: 411768

- 6 ROVER MASKS



- 6 ROVER S SNORKELS



- 2 SILICONE STRAPS



- 4 SPARE BUCKLES



- 4 STRAP'S LOOPS



- 1 SILICONE MOUTHPIECE



COLOR VARIATIONS



ROVER PRO

Code: 411519

- CURVED, ERGONOMIC STRUCTURE
- INTEGRATED KEEPER
- EXHAUST VALVE
- SILITER MOUTHPIECE

COLOR VARIATIONS



ROVER S

Code: 411478

- CURVED, ERGONOMIC STRUCTURE
- INTEGRATED KEEPER
- SILICONE MOUTHPIECE

COLOR VARIATIONS



ROVER HD

Code: 411266

- HEAVY DUTY CONSTRUCTION
- INTEGRATED BUCKLES SYSTEM ON FRAME, EASY TO USE EVEN WITH GLOVES
- WIDE RANGE OF FITTING
- EXTREMELY COMFORTABLE SILICONE SKIRT
- COMPLETE RANGE OF OPTICAL LENSES AVAILABLE



COLOR VARIATIONS

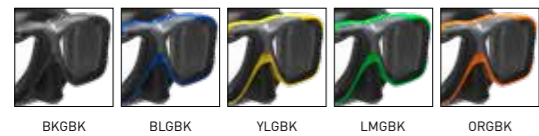

ACCESSORIES

Optical lens* [from -1,5 to -6,0 / +1,75 +2,25 +2,75]	411195
---	--------

ROVER HD MASKS & SNORKEL SET

Code: 411799

- 6 ROVER HD MASKS



- 6 ROVER SNORKELS



- 2 TOP FRAME



- 2 SILICONE STRAPS



- 4 STRAP'S LOOPS



- 4 BUCKLE'S ROLLERS



- 1 SILICONE MOUTHPIECE



COLOR VARIATIONS



ACCESSORIES

Optical lens* [from -1,5 to -6,0 / +1,75 +2,25 +2,75]	411195
---	--------

*Our optical lenses conform to norm EN 16805. They are not medical devices.

ROVER HD

The Rover HD (Heavy Duty) mask was specifically designed to be resilient and durable, ideal for intensive use, such as in Diving Centers and for rentals. It's available both as an individual product (code 411266), and as a six-piece set, paired with snorkels and spare parts (code 411799).



SCAN THE QR CODE TO SEE OUR OPTICAL LENS INSTALLING VIDEO GUIDE

FRAME

The frame, in five color options, is thicker to better withstand abuse, sanitizing and maintenance treatments.

FITTING

Features the new Super-Fit silicone skirt that can adapt to all facial types.



OPTICAL RX LENSES

The neutral lenses can be replaced with optical lenses 411195, available in three positive (+1.75, +2.25, +2.75) and ten negative (from -1.5 to -6) diopters.

BUCKLES

The buckles are integrated into the frame and are rugged. They feature large buttons that are easy to use even when wearing gloves.

AVANTI PURE

Code: 410028



- A 2-MATERIAL, OPEN HEEL FIN
- CAN BE USED BAREFOOT OR WITH MARES PURE BOOTIES
- SOFT AND COMFORTABLE FOOT POCKET
- ERGONOMIC HEEL PAD (PATENT PENDING) MINIMIZES PRESSURE ON THE ACHILLES' TENDON
- SPECIAL BUNGEE STRAP FOR MAXIMUM COMFORT DURING USE, WHEN DONNING AND DOFFING
- THE LOOPS ON THE FOOT POCKET MAINTAIN THE STRAP IN THE CORRECT POSITION



COLOR VARIATIONS



BGR

TECHNICAL FEATURES

Sizes	XXS	SM	M/L	L/XL
Fit	30/34	35/38	39/43	44/47
Blade*	27 cm / 10.6 in	29,5 cm / 11.6 in	32 cm / 12.6 in	34,5 cm / 13.6 in



* From end of footpocket to end of blade

AVANTI HC

Code: 410346



- ERGONOMIC FOOT POCKET. THE LATERAL RIB DISCHARGES PRESSURE IN LINE WITH THE FOOT, PREVENTING LATERAL COMPRESSION
- HYPERCHANNEL-INDUCED THRUST EFFECT WITH AN INCREASED PERFORMANCE/EFFORT RATIO
- RIDGES ON THE BACK OF THE BLADE: REINFORCE THE BLADE WHILE OPTIMIZING PIVOTING GEOMETRY



COLOR VARIATIONS



YL

BL

GR

TECHNICAL FEATURES

Sizes	36/37	38/39	40/41	42/43	44/45	46/47
Blade*	32,5 cm / 12.8 in	34,5 cm / 13.5 in	36 cm / 14.2 in	38 cm / 15 in	40 cm / 15.7 in	42 cm / 16.5 in



PLANA AVANTI X3

Code: 410001



- ABS PLUS BUCKLE FOR ONE HAND ADJUSTMENT
- 3 CHANNELS FOR MAXIMUM THRUST
- STABILIZING TRIM TABS
- MID-SIZE BLADE WITH DURABLE CONSTRUCTION



COLOR VARIATIONS



YL

BL

BK

TECHNICAL FEATURES

Sizes	XS	S	R	XL
Blade*	33 cm / 13.0 in	35 cm / 13.7 in	37 cm / 14.5 in	37 cm / 14.5 in



* From end of footpocket to end of blade

AVANTI TRE

Code: 410302



- ORTHOPEDIC FOOT POCKET
- 3 CHANNELS FOR MAXIMUM THRUST
- MID-SIZE BLADE WITH DURABLE CONSTRUCTION
- STABILIZING TRIM TABS



COLOR VARIATIONS



YL

BL

BK

TECHNICAL FEATURES

Sizes	36/37	38/39	40/41	42/43	44/45	46/47
Blade*	31 cm / 12.2 in	33 cm / 13 in	34 cm / 13.4 in	36 cm / 14.2 in	36,5 cm / 14.5 in	37,5 cm / 14.8 in

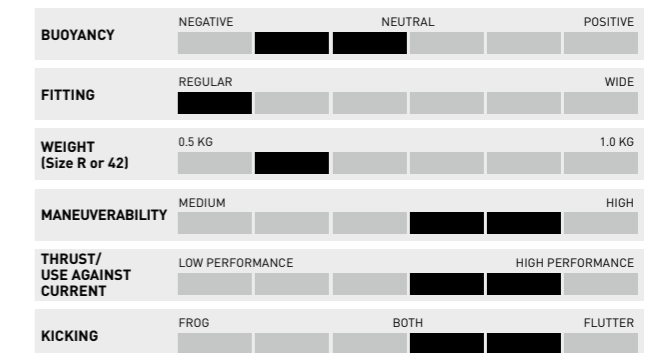

ROVER 10LR

Code: 415695

Code: 415696 - DC Pack (MOQ 6pcs)

LED BATTERY CHARGE INDICATOR
RECHARGEABLE BATTERY

- CREE LED
- OVER 2 HOURS AND 30 MINUTES BURN TIME (MAX POWER)
- POWERFUL LIGHT BEAM
- VISUAL BATTERY CHARGE INDICATOR
- IN-HOUSE RECHARGEABLE BATTERY
- USB CHARGING CABLE
- VISUAL LED CHARGE INDICATOR
- MULTIFUNCTIONAL MECHANICAL SWITCH
- AN "ELECTRONIC LOCK" SYSTEM PREVENTS THE TORCH FROM BEING ACCIDENTALLY SWITCHED ON - DOUBLE CLICK THE SWITCH TO TURN ON THE TORCH
- FOUR OPTIONS: ON, LOW, SOS, OFF
- HANDY AND COMPACT
- ADJUSTABLE WRIST STRAP



EOS STROBE

Code: 415693

- 450 LUMENS
- 360° HIGH VISIBILITY
- 5/25 HOURS OF BURN TIME
- IN-HOUSE RECHARGEABLE BATTERY
- USB RECHARGEABLE CABLE
- LED CHARGE INDICATOR
- MAGNETIC, ROTATIONAL SWITCH
- TWO OPERATING MODES: ON, STROBE
- ANODIZED ALUMINUM HOUSING
- ADJUSTABLE STRAP
- PADDED CASE WITH ZIP



TECHNICAL FEATURES

Bulb	1pcsXPL-V6-LED		
Switch Mode	High	Low	Flash/SOS
Led lumens (25°)	950	500	/
Burn time (min)	166	230	210
Color temperature (k)	5800-7300		
Light beam (1m distance)	Hot Spot (12°)		
(mm/in)	200/7.9		
Rechargeable batteries (li-ion)	1 x ICR18650		
Time to charge	240 min		
Total length (mm/in)	153.9/6.1		
Head diameter (mm/in)	35/1.4		
Body diameter (mm/in)	28/1.1		
Weight with batteries (gr/oz)	172/6.0		
Max operating depth (m/feet)	100/328		

TECHNICAL FEATURES

Bulb	1 Cree XPE LED Chip	
Switch mode	High	Flash/SOS
Led lumens (25°)	450	/
Burn time (min)	300	1500
Color temperature (k)	5800 ÷ 7300	
Light beam (1m distance)	Diffused light	
Flash Rate (p/min)	120	
Rechargeable batteries (li-ion)	1x ICR26650	
Time to charge	6 h (5V1A adapter) - 12 h (PC 500mA)	
Total length (mm/in)	170 / 6.6	
Head diameter (mm/in)	39 / 1.6	
Body diameter (mm/in)	34 / 1.4	
Weight with batteries (gr/oz)	245 / 8.6	
Max operating depth (m/feet)	100 / 328	

CRUISE DRY ATTACK TITAN

Code: 415524

- HEAT SEALED BAG WITHOUT STITCHING
- 500D TARPAULIN, STURDY AND LIGHTWEIGHT
- FOLDABLE WITH A LARGE INTERNAL VOLUME
- ADJUSTABLE HANDLES
- SIDE DRAIN VALVE



TECHNICAL FEATURES

Dimensions (LxWxH)	Unit Net Weight	Volume
90x46x35 cm / 35.4"x 18.1"x 13.7"	1,7Kg / 3,7lb	144 L / 8787 cu.in

PROTECTION BAG

Code: 44201169

- NEOPRENE BAG WITH ADJUSTABLE CLOSURE SYSTEM
- THE PERFECT SOLUTION TO PROTECT 2ND STAGES AND THE BCV INFLATOR BODY
- IDEAL FOR STORING AND PROTECTING A MASK, COMPUTER AND PERSONAL BELONGINGS



ROLL OF WEBBING

Code: 415128

- 50m/45Y EACH ROLL
- CUSTOMIZABLE ACCORDING TO DC NEEDS
- MARES SILVER LOGO
- PERFECT FOR MARES STAINLESS STEEL BUCKLE



WEIGHT BELT BUCKLES

Code: 415129

- STAINLESS STEEL
- "V" SHAPE FRONT FLAP TO CLOSE EASILY
- MARES EMBOSSED LOGO
- 10PCS KIT
- IDEAL FOR MARES WEBBING ROLL



ALUMINUM TANK

Code: pls contact your local distributor

- 12L / 80CFT, THE IDEAL SIZE FOR DC
- US DOT-3AL BRUSHED ALUMINUM
- 3 VERTICAL SILKSCREEN MARES DC LOGOS



TANK NETS

Code: 415749 10L YL

Code: 415731 12L BL

Code: 415730 15L BK

- HIGH QUALITY NYLON
- VARIOUS COLORS & SIZES
- 10L/YELLOW, 12L/BLUE AND 15L/BLACK



TANK VALVE DC

Code: 415064 Single Connection

- FOR ALUMINUM TANK
- INT/DIN
- BURST DISC



VALVE 2ND CONNECTION*

Code: 45200439

- INT/DIN VALVE CONNECTION LEFT
- OPTIONAL FOR 10 AND 12 LITER TANK VALVES



TANK VALVES**

Code: 45200446 Single Connection (EN 144-1)

- M25 X 2
- INT/DIN



Code: 45200448 Double Connection (EN 144-1)

- M25 X 2
- INT/DIN



* Assembly, checks and any necessary adjustments must be done by a Mares lab Authorized Service Center
 ** To assemble the valve on the tank must be done by a Authorized Service Center comply with Country regulations



PROMO MATERIAL



BASEBALL CAP / MARES JUST ADD WATER

Code: 449025

- 100% COTTON
- EMBROIDERED LOGO



HAT / PURE PASSION

Code: 449242

- MICROFLEECE
- 100% POLYESTER
- EMBROIDERED LOGO



NECKWARMER

Code: 449015

- MICROFIBER ORIGINAL BUFF
- PRINTED ALL LOGOS (MARES, XR, PP, DC)

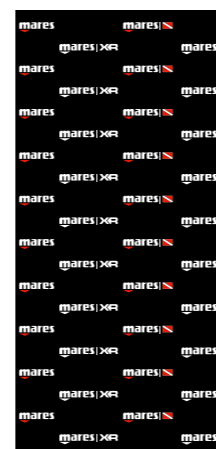

TENT

Code: 449932

- ALUMINIUM TENT WITH TOP
- SIZE: APPROX 3X3 m



SIDE PANELS FOR TENT

Code: 449942

- 2 PCS



TOP FOR TENT

Code: 449941

- SPARE PART

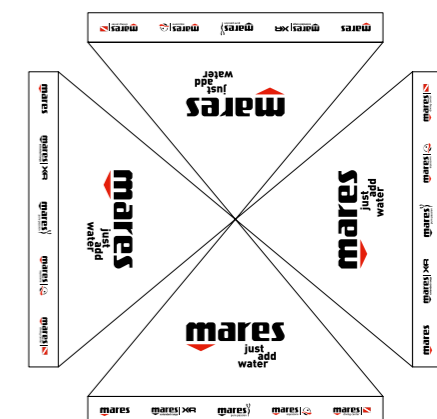

BANNER PVC

Code: **449919**
Code: **449918**

- SIZE: 150X50 cm
- SIZE: 3X1 m
- 100% PVC

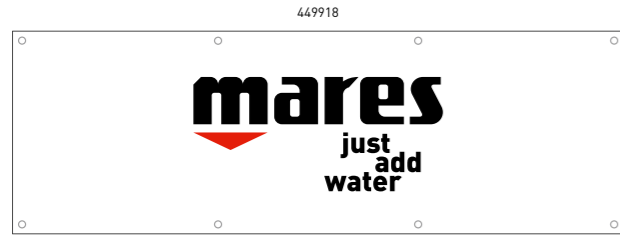

PEN FLAG

Code: **449910**
Code: **449911**

- SIZE: 40X180 cm - INDOOR (WITH BASE)
- SIZE: 40X300 cm - OUTDOOR (WITHOUT BASE)
- 100% NYLON

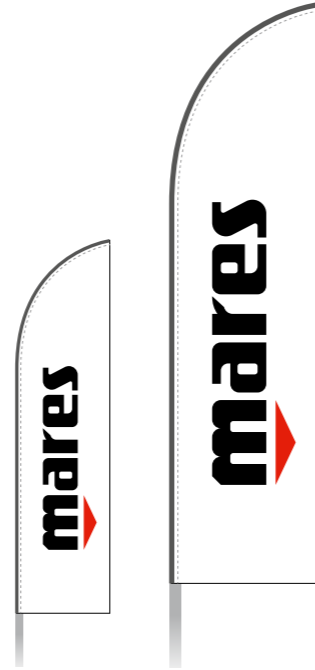

FLAG

Code: **449917**

- SIZE: 140X90 cm
- 100% NYLON



DISPLAY BLACK TANK 12L

Code: **449660**

- DIAMETER: 170 mm - CIRCUMFERENCE: 542 mm - HEIGHT: 645 mm
- TANK NECK THREAD: M25X2 EN144-1 - NO VALVE SUPPLIED
- WEIGHT: 1.8 Kg
- BLACK



PEN FLAG

Code: **449945**

- SIZE: 40X180 cm - INDOOR (WITH BASE)
- 100% NYLON



FLAG

Code: **449946**

- SIZE: 140X90 cm



STICKER

Code: **449848**

- SIZE: 20X5 cm
- 1 PACK = 50 PCS



PEN FLAG

Code: 449221

- SIZE: 40X180 cm - INDOOR (WITH BASE)
- 100% NYLON



FREEDIVING STICKER

Code: 449951

- SIZE: 4,5X16 cm
- 1 PACK = 50 PCS



GRID DISPLAY

Code: 449683

- SIZE: 100x200x35 cm
- MOVABLE WITH 4 WHEELS
- DISPLAY SPACE ON BOTH SIDES



HOOKS FOR GRID DISPLAY

Code: 449685

- 15 METAL HOOKS

SSI EDUCATIONAL PROGRAM

- THE QR CODE ON AQUAZONE PACKAGING SENDS THE USER TO A FREE SSI TRAINING VIDEO WHICH COVERS THE BASICS OF SNORKELING GEAR AND SOME USEFUL SAFETY TIPS
- AFTER COMPLETING THE REGISTRATION, CUSTOMERS CAN:
 - TAKE PART IN A PRACTICAL SSI SNORKELING MODULE AT THEIR NEAREST SSI TRAINING CENTER
 - CONTINUE THEIR DIVING EDUCATION WITH FURTHER SSI PROGRAMS AND CERTIFICATIONS



BANNER PVC

Code: **449922**
Code: **449921**

- SIZE: 150X50 cm - CODE 449922
- SIZE: 3X1 m - CODE 449921
- 100% PVC

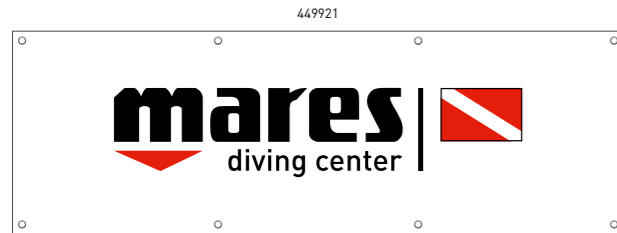
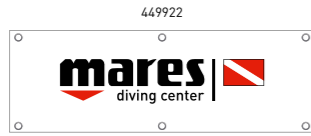

PEN FLAG

Code: **449923**
Code: **449924**

- SIZE: 40X180 cm - INDOOR (WITH BASE)
- SIZE: 40X300 cm - OUTDOOR (WITHOUT BASE)
- 100% NYLON



FLAG

Code: **449920**

- SIZE: 140X90 cm
- 100% NYLON



BOAT FLAG

Code: **449950**

- SIZE: 60X50 cm
- 100% NYLON



RDWH



WHBL



MARES LAB





THE MARES LAB SERVICE TECHNICIAN TRAINING PROGRAM

Mares Service Technician Training Courses are available throughout the world and are designed and developed based on proven effective instructional system design principals. They are the dive industry's first and only competency based service technician training courses offered worldwide that are produced and conducted by a major dive equipment manufacturer. This means you'll receive the same high quality and educationally valid training regardless of where in the world you participate in a Mares Service Technician Training Course.



BASIC SERVICE TECHNICIAN DIGITAL LEARNING COURSE

This highly interactive online digital learning course is delivered to the learner using the latest Educational Management System (EMS) technology. The EMS platform technology along with extensive use of video and graphic content enhances learning and retention of information and produces a highly enjoyable educational experience. The course is open to anyone, and can be accessed by contacting the local Mares Subsidiary or Distributor. Take this course as the first step to becoming a fully qualified Mares Service Technician, or if you simply want to learn the basics of regulator design and service and/or repair. This course is a prerequisite requirement for most Mares Lab Skill Based Training Courses. Completion of this course does not qualify you to service or repair Mares equipment.



The course goals are to:

1. Establish your basic knowledge level relating to regulator service and repair procedures.
2. Provide you with basic information about regulator design and function.
3. Provide you with Mares specific information relating to service and repair procedures, manufacturing processes and product information.
4. Help prepare you for success in one or more Mares Lab Skill Based Training Courses.

Prerequisite Requirements:
Course is open to anyone.

MARES LAB SKILL BASED TRAINING COURSES

- MARES SERVICE TECHNICIAN
- MARES DIVING CENTER SERVICE TECHNICIAN
- MARES SPECIALTY SERVICE TECHNICIAN



After successfully completing the Basic Service Technician Digital Learning Course, you are now ready to progress to the skill based training phase of becoming a qualified Mares Service Technician. These courses are conducted by qualified Mares Lab Instructors and consist of comprehensive hands-on training exercises. During these courses you will have the opportunity to perform multiple service procedures on a wide variety of Mares products, including multiple complete regulator service overhauls on various Mares regulators. You'll also gain valuable experience in using the Mares Service Manual and Spare Parts Catalog during routine and special service procedures. Skill based training courses are designed to:

1. Provide comprehensive, real world, hands-on training about how to service and repair Mares products.
2. Enhance the knowledge gained from the Basic Service Technician Digital Learning Course.
3. Develop skills and abilities to the level required to successfully perform service and repair procedures on Mares products.
4. Prepare you for a successful full or part-time career as a Mares Service Technician.



• MARES SERVICE TECHNICIAN

This is by far the most popular of the skill based training courses. The all new and redesigned Mares Service Technician Training Course is a comprehensive 2 day training program that trains and qualifies individuals to service and repair Mares products. Topics include disassembly, reassembly and adjustment of in-line Mares regulators, service and repair procedures, troubleshooting, dive computers, Mares warranty, service guidelines and more. More than 12 hours of course time is dedicated to hands-on, skill based training on how to properly disassemble, reassemble and adjust Mares regulators and BC inflator mechanisms. **Successful completion of this course qualifies you to service and/or repair ALL Mares products.**

Prerequisite Requirements:

Completion of the Basic Service Technician Digital Learning Course.
Be currently affiliated with an Authorized Mares Dealer.
Be approved by the affiliated Mares Dealer to attend the course.

• MARES DIVING CENTER SERVICE TECHNICIAN

This course is designed for technicians who plan to work in a Mares Diving Center, such as a resort or diver training facility, that has limited or no retail sale of Mares equipment. Course duration is 1 day and provides skill based training related to the Mares Diving Center product line. Take this course if you plan to work in a Mares Diving Center and are interested in being able to service and repair your affiliated Mares Diving Center owned Mares products. **Successful completion of the Diving Center Service Technician Course qualifies you to service and repair ONLY your affiliated Diving Center OWNED equipment used in rental and/or training programs.**

Prerequisite Requirements:

Completion of the Basic Service Technician Digital Learning Course.
Be affiliated with an Authorized Mares Diving Center.
Be approved by the affiliated Mares Diving Center to attend the course.

• MARES SPECIALTY SERVICE TECHNICIAN

These courses are designed to train technicians to service and repair specific Mares products. Specialty Service Technician Training Course duration is approximately 1 day, depending on the course requirements and the number of products included in the course. **Successful completion of this course qualifies you to service and/or repair ONLY the specific Mares products for which you were trained.** These products will be listed on your qualification certificate. Contact your local Mares Subsidiary or Distributor for additional information on Specialty Service Technician Training Courses available in your area.

Prerequisite Requirements:

This varies according to the specific Specialty Service Technician Training Course requirements.
Authorization by a current Mares Dive Center or Mares Dealer.

• MARES SERVICE TECHNICIAN UPDATE

In order to maintain your Mares Service Technician qualification, you must attend the Annual Service Technician Online Renewal within one (1) year* of completing a Service Technician Training Course. Annual Service Technician Online Renewals are available online and are conducted regularly every year from October 15th to December 15th.
* Within one (1) year is defined as before December 31st of the year in which the one year limit is reached.

Prerequisite Requirements:

Currently qualified as a Mares Lab Service Technician.
Qualification date is within the one (1) year update requirement.

THE MARES LAB TRAINING CYCLE®

The Mares Lab Training Cycle is a process that has proven effective in producing what we call "best in class results". This means that as a qualified Mares Service Technician, you can be confident that you've successfully completed the dive industry's most comprehensive dive equipment service and repair training program available through a dive equipment manufacturer. You can also be proud of the fact that you earned your qualification by demonstrating a "best in class" level of dive equipment service technician skills and abilities. Here's how the Mares Lab Training Cycle works:

Your Knowledge Development

Your basic dive equipment service and repair knowledge is established during your digital learning course and further enhanced during your skill based training course.

Your Skill Development

Your service and repair skills are enhanced during your skill based training course through a series of hands-on training exercises. Over 90% of the contact hours in these courses are dedicated to skill development.



Your Abilities Confirmed

Your knowledge and skill levels achieved through the Mares Lab training process are objectively evaluated and must meet the minimum core competency requirements in order to be qualified as a Mares Service Technician.

Your Abilities Improved

Your abilities improve over time by gaining additional knowledge and increasing skill levels. This is achieved through experience as a Mares Service Technician, by regular contact and communication with Mares Technical Assistance staff, by receiving periodic product updates and Service Bulletins and by participating in Service Technician Update Seminars.

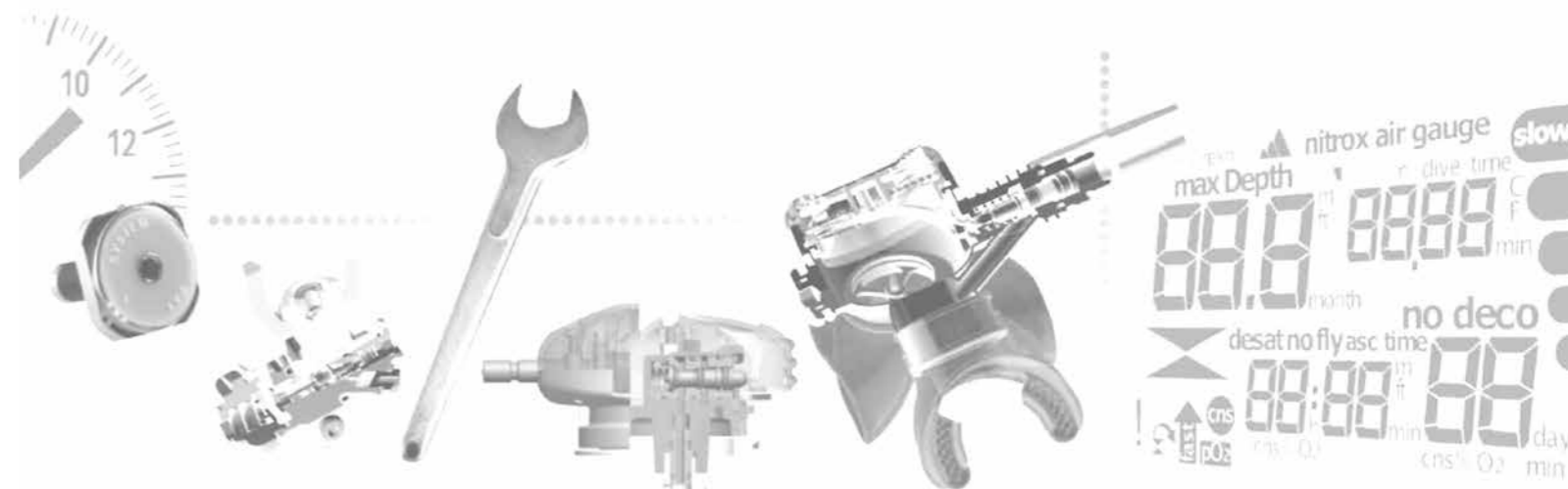



Product specifications and characteristics listed in this catalogue may be subject to changes by Mares without notice.

The trademark **mares**® is a registered trademark.

PHOTO CREDITS:

Alberto Balbi - Bob Bobisavljevic - Adv Consulting - Marco Daturi - Alex Dawson - Massimiliano Eleota - Janez Kranjc - Gerald Nowak - Ivana Orlovic Kranjc - Virginia Salzedo - Tom St George - Dejan Subotic - Vladimir Subotic - Fulvio Valogolio - Predrag Yuckovic - Axel Weiss

ISO 9001:2015 certified

mares



Mares S.p.A.
Salita Bonsen 4
P.O. Box 142
16035 Rapallo (Genova) - ITALY
Tel. +39 0185 2011 / fax +39 0185 201470
www.mares.com